

Ku-band 3W BUC

MODEL No. NJT5037/97 series

< Features >

- * **High Efficiency & Low Distortion**
 - P1dB: +35 dBm typ. over temperature
 - Power Consumption: 30 W
 - ACPR: -26 dBc max. @ Pout = +32 dBm
- * **Small Size & Light Weight**
 - Weight: 1.2 kg
- * **RoHS Compliance**



< Line-Up >

Model No.	RF Frequency	Local Frequency	IF Frequency	Output Power @ P1dB	IF Connector	Power Supply
NJT5037	14.0 to 14.5 GHz (Ku-band)	13.05 GHz	950 to 1,450 MHz	3W Linear (+35 dBm typ.)	N-type	+24 VDC (+15 to +30 VDC)
NJT5037F					F-type	
NJT5097	13.75 to 14.25 GHz (Extended Ku-band)	12.8 GHz			N-type	
NJT5097F					F-type	

< Specifications >

Item	Specifications
Output Interface	Waveguide, WR75 (with Groove)
Input Interface	N-type, female (50 ohm) [Model No.: NJT5037/97] F-type, female (75 ohm) [Model No.: NJT5037F/97F]
Output Power @ 1 dB G.C.P.	+35 dBm typ., +33 dBm min. over temperature
Linear Gain	53 dB nom.
ACPR Compliance with IESS308 / SSOG	-26 dBc max. @ Pout = +32 dBm
Requirement for External Reference	[Frequency] 10 MHz (sine-wave) [Input Power] -5 to +5 dBm @ Input port [Phase Noise] -125 dBc/Hz max. @ 100 Hz -135 dBc/Hz max. @ 1 kHz -140 dBc/Hz max. @ 10 kHz
L.O. Phase Noise	-60 dBc/Hz max. @ 100 Hz -70 dBc/Hz max. @ 1 kHz -80 dBc/Hz max. @ 10 kHz -90 dBc/Hz max. @ 100 kHz
Receive Band Noise Density	-110 dBm/50kHz max. @10.95 to 12.75 GHz
Input V.S.W.R.	2.0 : 1 max.
Output V.S.W.R.	2.0 : 1 max.
Power Requirement	+24 VDC (+15 to +30 VDC)
Power Consumption	30 W max.
Mute	Shut off the HPA in case of L.O. unlocked or no 10 MHz reference signal.
Temperature Range (ambient)	-40 to +55 C (operating), -40 to +75 C (storage)
Dimension & Housing (without Interface Connectors)	172.9 mm (L) x 119 mm (W) x 44.5 mm (H) [6.81" (L) x 4.69" (W) x 1.75" (H)]
Weight	1.2 kg [2.6 lbs]

■ Ku-band 3W BUC

MODEL No. **NJT5037/97** series

< Outline Drawing >
NJT5037/97

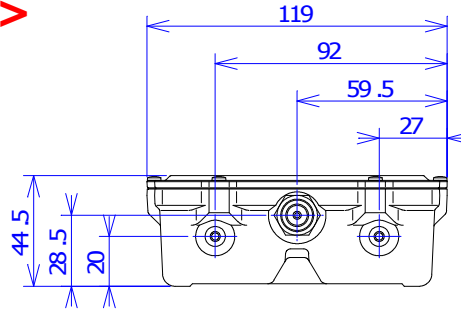

N-type, female connector
 IF / Ref. (10MHz)
 DC Power: +15 to +30 VDC

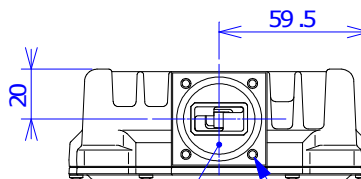
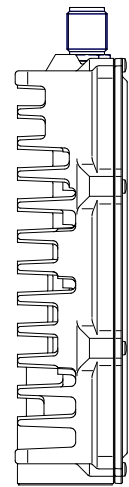
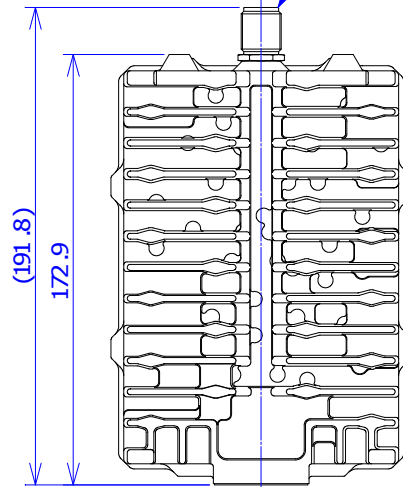
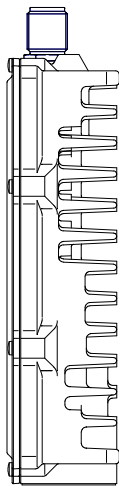

WR-75 4-M4 depth 6 min.

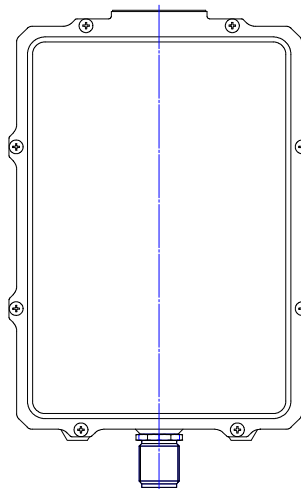

Unit: mm

■ Ku-band 3W BUC

MODEL No. **NJT5037/97** series

< Outline Drawing >
NJT5037F/97F

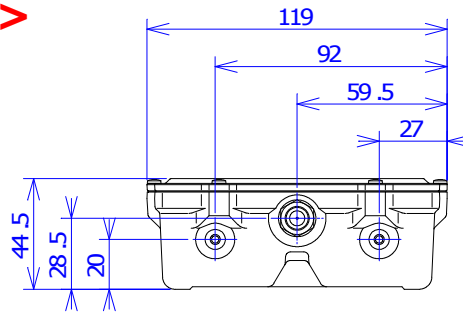

F-type, female connector
 IF / Ref. (10MHz)
 DC Power: +15 to +30 VDC

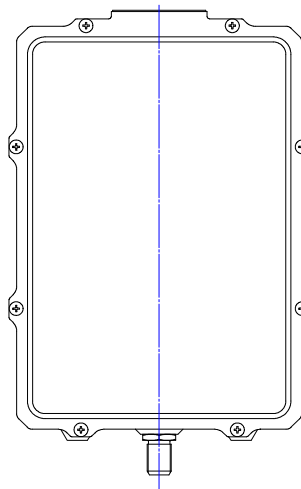
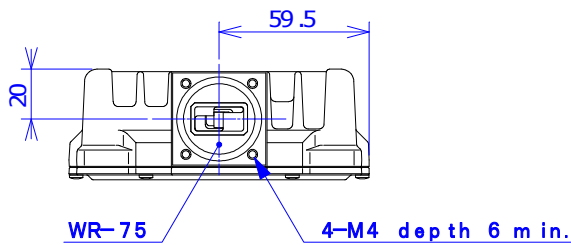
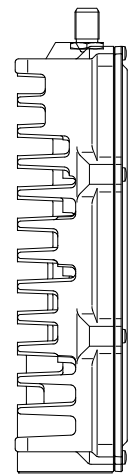
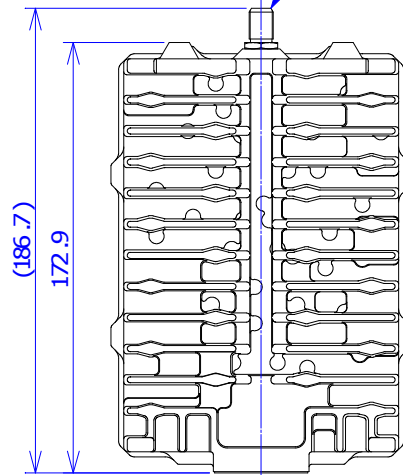
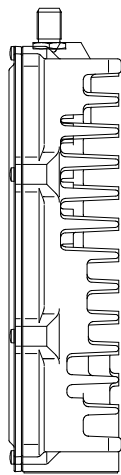

Unit: mm