



Intelligent Block Upconverters and Transmit Redundant Systems

Operations Manual

24-Hour Technical Support: +1 408.782.2166

This document is provided to customers who have purchased Terrasat Communications, Inc. equipment. This document is copyright protected and no part of this manual may be reproduced, transcribed, or translated into any language or transmitted in any form whatsoever without the prior written consent of Terrasat Communications, Inc.

Technical information contained in this publication is for reference purposes only and is subject to change without notice. Every effort has been made to supply complete and accurate information; however, Terrasat Communications, Inc. assumes no responsibility and will not be liable for any errors, omissions, damage, or loss that might result from any use of this manual or the information contained therein (even if this information is properly followed and problems still arise).

Part Number: 10770-0001

Revision: F

© February 2013 Terrasat Communications, Inc.

235 Vineyard Court
Morgan Hill, CA 95037

Phone: +1 408.782.5911
FAX: +1 408.782.5912

www.terrasatinc.com

TABLE OF CONTENTS

Preface

| | |
|----------------------------------|-----|
| Conventions and References | P-1 |
| Cautions and Warnings | P-2 |
| Trademarks..... | P-2 |
| Electrical Safety Notice | P-2 |

Chapter 1, Introduction

| | |
|--------------------------------------|-----|
| Intelligent Block Upconverters | 1-1 |
| Reference Documents | 1-2 |
| Warranty Information..... | 1-4 |
| X-Band IBUC Export Regulations..... | 1-5 |
| ANATEL Compliance..... | 1-6 |

Chapter 2, IBUC Functional Description

| | |
|----------------------------|------|
| System Components..... | 2-1 |
| DC Supply..... | 2-3 |
| AC Supply..... | 2-3 |
| Fuses..... | 2-4 |
| Monitor and Control..... | 2-11 |
| RF Signal Flow | 2-12 |
| Software | 2-16 |
| System Configurations..... | 2-17 |
| Storage Information | 2-23 |

Chapter 3, IBUC Installation

| | |
|----------------------------------|------|
| General Requirements | 3-1 |
| Unpacking | 3-1 |
| Furnished Items..... | 3-2 |
| Accessories..... | 3-4 |
| Installing the ODU | 3-6 |
| Tools and Test Equipment | 3-6 |
| Site Considerations | 3-6 |
| Mounting Considerations..... | 3-6 |
| Power Requirements | 3-6 |
| Grounding | 3-8 |
| Antenna Recommendations | 3-9 |
| Antenna Mounting | 3-9 |
| System Pressurization | 3-15 |
| System Cabling Requirements..... | 3-16 |

| | |
|---|------|
| Cable and Waveguide Connections | 3-24 |
| Basic System Alignment | 3-27 |
| Test Equipment | 3-28 |
| Setting the Tx and Rx Frequencies | 3-28 |
| Transmit Power Alignment | 3-29 |
| Final Checks | 3-30 |

Chapter 4, Operations

| | |
|--|-----|
| Start-up Checklist | 4-1 |
| Turning On the IBUC | 4-2 |
| Setting Operating Parameters | 4-2 |
| Setting the Tx frequency (L-band) | 4-4 |
| Setting Alarm Thresholds | 4-4 |
| Configuring Alarm States | 4-5 |
| Configuring ALC/AGC | 4-5 |
| Configuring the External Mute | 4-6 |
| Common Errors | 4-7 |
| LED is Red | 4-7 |
| No Power to the IBUC | 4-7 |
| Time Stamp Data is Incorrect | 4-8 |
| System Time Stamp is Different | 4-8 |
| Satellite Network Operations Center Doesn't Recognize Signal | 4-8 |
| Transmit Power in Saturation | 4-9 |
| Tx Input/Output Level Verification | 4-9 |

Chapter 5, Monitor and Control Features and Functions

| | |
|---|------|
| M & C Interfaces | 5-1 |
| RS232 | 5-1 |
| Hand-held Terminal | 5-2 |
| Multifunction LEDs | 5-3 |
| Frequency Shift Keying (FSK) Modem Interface | 5-4 |
| RS485 | 5-5 |
| ASCII Mode | 5-6 |
| Legacy Binary Mode | 5-7 |
| Ethernet | 5-8 |
| Determining the IP Address of Your IBUC or IBUC 2 | 5-9 |
| Telnet | 5-14 |
| Web Server | 5-14 |
| SNMP | 5-15 |
| Power Measurement | 5-17 |

Chapter 6, Troubleshooting

| | |
|-----------------------------------|-----|
| Maintenance | 6-1 |
| Transceiver Fault Isolation | 6-1 |

| | |
|--|-----|
| AC Power Problems/Conditioning | 6-1 |
| Site-Related Problems | 6-2 |
| M&C Checks | 6-2 |
| Power Supply Checks | 6-2 |
| Transmit Power Setting | 6-3 |
| Common Problems | 6-5 |
| Tx Output is Disabled | 6-5 |
| Incorrect Frequency Settings | 6-5 |
| Damaged Cables | 6-5 |
| 10 MHz Reference Signal at the IBUC is at the Wrong Level or Missing | 6-5 |
| Antenna is Pointed Toward Wrong Satellite or is Misaligned | 6-6 |
| Moisture Migrated Into the IBUC | 6-6 |
| Bad Orthogonal Mode Transducer and/or Antenna | 6-7 |
| LED is Red | 6-7 |
| Repair Policy..... | 6-7 |
| Returned Material Authorization (RMA) | 6-8 |

Chapter 7, IBUC Transmit Redundant Systems

| | |
|--|------|
| Description..... | 7-1 |
| Interface for Tx Redundant (1+1) Systems | 7-1 |
| Component Descriptions | 7-3 |
| Intelligent Block Upconverter (IBUC) | 7-4 |
| Tx 1+1 Interface Module..... | 7-4 |
| Waveguide Switch..... | 7-5 |
| Software..... | 7-5 |
| Installation and Setup | 7-6 |
| System Cabling Requirements..... | 7-7 |
| Interfaces | 7-7 |
| Tx 1+1 Interface Module..... | 7-7 |
| Cable and Waveguide Connections..... | 7-11 |
| Water-Resistant Wrap..... | 7-11 |
| Waveguide Connection..... | 7-12 |
| Typical Configuration..... | 7-12 |
| Grounding..... | 7-12 |
| System Alignment and Operation..... | 7-14 |
| General..... | 7-14 |
| Tx Power Alignment | 7-15 |
| Final Checks | 7-16 |
| M&C Setup..... | 7-17 |
| Service and Maintenance..... | 7-23 |
| Standard Maintenance | 7-23 |
| Fault Isolation..... | 7-23 |
| Common Problems | 7-26 |
| Repair Policy | 7-26 |

| | |
|-----------------------|------|
| M&C Functions..... | 7-26 |
| User Interfaces | 7-27 |

Appendix A, Part Numbering Schema

| | |
|---|-----|
| Identifying the Part and Serial Numbers | A-1 |
|---|-----|

Appendix B, Using HyperTerminal

| | |
|--|-----|
| Establishing a HyperTerminal Session | B-1 |
| Using a Saved Connection | B-7 |
| Ending a HyperTerminal Session..... | B-8 |

Appendix C, ASCII Command/Response Structure

| | |
|-----------------------------|------|
| Command Set | C-1 |
| Common Commands..... | C-4 |
| Receive-only Commands | C-18 |
| Transmit-only Commands..... | C-25 |
| Redundancy Commands..... | C-42 |

Appendix D, Legacy Binary Command Message Structure

| | |
|---|-----|
| Command Set | D-1 |
| Legacy Response Message Structure | D-3 |
| Data Field Definitions | D-5 |

Appendix E, IBUC Hand-held Terminal Menu Tree

| | |
|---------------------|-----|
| Menu Options | E-1 |
| Info & Sensors..... | E-4 |
| Tx | E-4 |
| Alarm..... | E-5 |
| Tx Thresholds..... | E-5 |
| Interface..... | E-5 |
| SNMP | E-6 |
| System..... | E-6 |
| Redundancy..... | E-6 |

Appendix F, IBUC Web Pages

| | |
|----------------------------------|------|
| Introduction | F-1 |
| Screen Shots | F-5 |
| Login | F-5 |
| Information Tab | F-6 |
| Alarm Tab | F-8 |
| Sensor Tab..... | F-11 |
| Transmit Configuration Tab..... | F-13 |
| Interface Configuration Tab..... | F-18 |

| | |
|-----------------------------------|------|
| System Configuration Tab | F-21 |
| Alarm Configuration Tab | F-24 |
| Redundancy Configuration Tab..... | F-27 |
| Alarm Log Tab | F-29 |

Appendix G, Component Specifications and Reference Drawings

| | |
|-------------------------|------|
| Reference Drawings..... | G-1 |
| Data Sheets | G-10 |

Appendix H, Glossary

| | |
|------------------------|-----|
| Glossary of Terms..... | H-1 |
|------------------------|-----|

Index

LIST OF TABLES

| | | |
|-----------|--|------|
| Table P.1 | Typographical Conventions | P-1 |
| Table 1.1 | Satellite Operation Standards..... | 1-2 |
| Table 1.2 | Transmissor para Estação Terrena - Categoria II..... | 1-6 |
| Table 2.1 | Transmit Frequency Plans..... | 2-2 |
| Table 2.2 | AC Supply Operating Voltage Ranges | 2-3 |
| Table 2.3 | Fuse Markings..... | 2-4 |
| Table 2.4 | Fuse Markings Explained | 2-5 |
| Table 2.5 | Internal 10 MHz Reference Signal Parameters..... | 2-12 |
| Table 2.6 | Basic System Requirements..... | 2-17 |
| Table 3.1 | IBUC Interface Connector Schedule..... | 3-20 |
| Table 3.2 | Pin Assignments for IBUC M&C Connector J2..... | 3-22 |
| Table 3.3 | Pin Assignments for IBUC DC Power Connector J3 | 3-22 |
| Table 3.4 | Pin Assignments for IBUC AC Power Connector J3 | 3-23 |
| Table 3.5 | Recommended Test Equipment | 3-28 |
| Table 5.1 | Default Alarm Configuration | 5-4 |
| Table 5.2 | Transmitter Link Specifications..... | 5-5 |
| Table 5.3 | Receiver Link Specifications | 5-5 |
| Table 5.4 | ASCII Mode Command Format..... | 5-6 |
| Table 5.5 | Packet Format | 5-8 |
| Table 5.6 | IBUC Data Packet Byte Configuration..... | 5-8 |
| Table 6.1 | Possible Scenarios for IBUCs with an External 10 MHz Reference Signal..... | 6-6 |
| Table 7.1 | Tx 1+1 Interface Module Connector Schedule | 7-8 |
| Table 7.2 | Pin Assignments for RS232, HHT, and Alarm Connectors J1 and J8..... | 7-8 |
| Table 7.3 | Pin Assignments for M&C Interface Connectors J2 and J4 | 7-9 |
| Table 7.4 | Pin Assignments for M&C Interface Connector J3 | 7-10 |
| Table 7.5 | Recommended Test Equipment | 7-14 |
| Table C.1 | Alarm Mask | C-1 |
| Table C.2 | Alarm Flags..... | C-2 |
| Table C.3 | Error Response Table..... | C-3 |
| Table C.4 | Default Values for the TAH, TAL, and TBT Commands | C-32 |
| Table C.5 | Default Values for the TFR Command | C-36 |
| Table D.1 | IBUC Commands..... | D-1 |
| Table D.2 | Response to IBUC Commands 0x01, 0x02, 0x03, 0x04, 0x08, and 0xFF | D-3 |
| Table D.3 | Response to IBUC Commands 0x05 and 0x06 (When Data Byte 1 of Command Message = 0x00)..... | D-3 |
| Table D.4 | Response to IBUC Command 0x06 (When Data Byte 1 of Command Message = 0x01)..... | D-4 |
| Table D.5 | Response to IBUC Command 0x07 | D-4 |
| Table D.6 | Response to IBUC Command 0x09 | D-5 |
| Table D.7 | Data Field Definitions..... | D-5 |

| | | |
|-----------|---|------|
| Table F.1 | Default Values for Power Monitor Frequency..... | F-14 |
| Table F.2 | Default Values for the Burst Threshold | F-15 |

LIST OF FIGURES

| | | |
|-------------|---|------|
| Figure 2.1 | Front Panel of a DC-powered IBUC Without an External Fan | 2-6 |
| Figure 2.2 | Front Panel of an AC-powered IBUC Without an External Fan | 2-7 |
| Figure 2.3 | Front Panel of a DC-powered IBUC With an External Fan | 2-8 |
| Figure 2.4 | Front Panel of an AC-powered IBUC With an External Fan | 2-9 |
| Figure 2.5 | Front Panel of a DC-powered High-Power IBUC | 2-10 |
| Figure 2.6 | Front Panel of an AC-powered High-Power IBUC | 2-11 |
| Figure 2.7 | IBUC Block Diagram (for DC-powered units)..... | 2-14 |
| Figure 2.8 | IBUC Block Diagram (for AC-powered units)..... | 2-15 |
| Figure 2.9 | Low-Power System Configuration | 2-19 |
| Figure 2.10 | Low-Power System Configuration with IFU | 2-20 |
| Figure 2.11 | High-Power System Configuration..... | 2-21 |
| Figure 2.12 | AC Power System Configuration..... | 2-22 |
| Figure 3.1 | Contents of IBUC Shipping Carton | 3-3 |
| Figure 3.2 | Contents of Tx 1+1 System Shipping Carton | 3-5 |
| Figure 3.3 | Mounting on Focal Point | 3-10 |
| Figure 3.4 | Mounting on Boom Arm..... | 3-11 |
| Figure 3.5 | Mounting on Antenna Back Structure | 3-12 |
| Figure 3.6 | Mounting in Hub..... | 3-13 |
| Figure 3.7 | Location of Mounting Holes | 3-14 |
| Figure 3.8 | Location of Mounting Slots on Optional Mounting Bracket..... | 3-15 |
| Figure 3.9 | Front Panel of Lower Power IBUC | 3-16 |
| Figure 3.10 | Back Panel of Lower Power IBUC..... | 3-17 |
| Figure 3.11 | Front Panel of Higher Power IBUC..... | 3-18 |
| Figure 3.12 | Back Panel of Higher Power IBUC | 3-19 |
| Figure 3.13 | Applying the Anti-Seize Lubricant..... | 3-25 |
| Figure 5.1 | IBUC Hand-held Terminal | 5-2 |
| Figure 5.2 | Location of Downloads on Terrasat Website..... | 5-10 |
| Figure 5.3 | Download Instructions for .zip File | 5-11 |
| Figure 5.4 | Contents of the IBUCUpgrade_v122 .zip File..... | 5-11 |
| Figure 5.5 | Extracting the .zip Files | 5-12 |
| Figure 5.6 | Security Warning Dialog Box..... | 5-12 |
| Figure 5.7 | Results Window | 5-13 |
| Figure 5.8 | Blank Results Window | 5-13 |
| Figure 7.1 | Transmit Redundant System Setup..... | 7-2 |
| Figure 7.2 | IBUC Redundant System Diagram..... | 7-3 |
| Figure 7.3 | Tx 1+1 Interface Module Block Diagram..... | 7-5 |
| Figure 7.4 | Tx 1+1 Interface Module Top View | 7-7 |
| Figure 7.5 | Multifunction LEDs for a Tx 1+1 System | 7-22 |
| Figure 7.6 | Hand-Held Terminal | 7-28 |
| Figure A.1 | Identifying the Part and Serial Numbers..... | A-1 |

| | | |
|-------------|---|------|
| Figure A.2 | Part Numbering Schema for IBUC 2s and IBRs | A-2 |
| Figure A.3 | Part Numbering Schema for IBUCs | A-3 |
| Figure A.4 | Part Numbering Schema for Transmit Redundant (Tx 1+1) Systems | A-4 |
| Figure A.5 | Part Numbering Schema for Receive Redundant (Rx 1+1) Systems | A-5 |
| Figure A.6 | Part Numbering Schema for IBUC with PSUI Systems..... | A-6 |
| Figure A.7 | Part Numbering Schema for IFU Systems..... | A-7 |
| Figure A.8 | Part Numbering Schema for LNBs..... | A-8 |
| Figure A.9 | Part Numbering Schema for SSPAs | A-9 |
| Figure A.10 | Part Numbering Schema for Redundant SSPA 1+1 Systems..... | A-10 |
| Figure B.1 | New Connection Description Window | B-2 |
| Figure B.2 | Connect To Window | B-3 |
| Figure B.3 | COM1 Properties Window..... | B-4 |
| Figure B.4 | Invalid Password Error Message..... | B-5 |
| Figure B.5 | ASCII Setup Window | B-5 |
| Figure B.6 | Invalid Value Error Message | B-6 |
| Figure B.7 | Active HyperTerminal Window..... | B-7 |
| Figure E.1 | Sample IBUC HHT Display | E-2 |
| Figure E.2 | Sample IBUC Info & Sensors Window | E-2 |
| Figure E.3 | IBUC Hand-held Terminal Menu Tree..... | E-3 |
| Figure F.1 | Choosing Network Connections | F-2 |
| Figure F.2 | Choosing the Internet Protocol (TCP/IP) Properties..... | F-2 |
| Figure F.3 | Typing the IP Address..... | F-3 |
| Figure F.4 | Invalid Subnet Mask Error Message..... | F-4 |
| Figure F.5 | Login..... | F-5 |
| Figure F.6 | Information Tab | F-6 |
| Figure F.7 | Alarm Status Tab | F-8 |
| Figure F.8 | Sensor Tab | F-11 |
| Figure F.9 | Tx Configuration Tab | F-13 |
| Figure F.10 | Interface Configuration Tab..... | F-18 |
| Figure F.11 | System Configuration Tab..... | F-21 |
| Figure F.12 | Alarm Configuration Tab..... | F-24 |
| Figure F.13 | Redundancy Configuration Tab..... | F-27 |
| Figure F.14 | Alarm Log Tab..... | F-29 |
| Figure G.1 | Fabrication Drawing, FBD-21012-XXXX, Rev A..... | G-2 |
| Figure G.2 | Fabrication Drawing, FBD-20786-XXXX, Rev A..... | G-3 |
| Figure G.3 | Example Installation Drawing for Antenna Mounting, 339-44001-XXXX Rev A, page 1 of 2 | G-4 |
| Figure G.4 | Example Installation Drawing for Antenna Mounting, 339-44001-XXXX Rev A, page 2 of 2 | G-5 |
| Figure G.5 | Example Installation Drawing, IND-10521-0001, Rev C | G-6 |
| Figure G.6 | Example Installation Drawing, IND-10521-0007, Rev C, page 1 of 2 | G-7 |
| Figure G.7 | Example Installation Drawing, IND-10521-0007, Rev C, page 2 of 2 | G-8 |
| Figure G.8 | Example Installation Drawing, IND-10521-0010, Rev A | G-9 |

REVISION HISTORY

| Revision | Date | Description |
|----------|---------------|---|
| A | June 2006 | Initial Release |
| B | July 2007 | <ul style="list-style-type: none"> • Updated product data for Terrasat Power Supply Units (PSUIs) • Updated IBUC product data for units with higher power ratings • Added commands for configuring SNMP operation on the IBUC • Added information about setting up the monitor and control (M&C) features • Added and updated outline drawings for new products |
| C | October 2010 | <ul style="list-style-type: none"> • Reformatted and migrated to FrameMaker v8.0 (added hypertext links and graphics) • Expanded transmit frequency plans • Added information about DBS-band and Ka-band model IBUCs • Added information about AC power supply • Added information about optional internal 10 MHz reference signal • Updated hand-held terminal menus and display information • Updated ASCII command list • Added list of contents of shipping carton(s) • Updated system configuration graphics • Expanded information about embedded Web pages • Added drawings of antenna mounting options • Updated list of MIBs |
| D | February 2011 | <ul style="list-style-type: none"> • Updated page layout • Correction to information about IP addresses in Appendix F • Added information about the CSF command for AC-powered IBUCs |

| Revision | Date | Description |
|----------|---------------|---|
| E | June 2011 | <ul style="list-style-type: none"> • Updated hyperlinks |
| F | February 2013 | <ul style="list-style-type: none"> • Added MIL-STD-188-164A to list of reference documents • Added information about alarm flags • Added information about the types of fuses used in AC-powered units • Added information about attaching a ferrite core when fabricating a supply cable • Added information about the readings on the Alarm tab of the embedded Web pages in Appendix F • Updated the warranty policy • Updated legacy binary data field definitions in Appendix D • Added information about applying the included anti-sieze lubricant • Added information about compliance with Anatel (Brazilian National Telecommunications Agency) requirements • Updated part numbering schema in Appendix A • Added information about how to determine the IP address of your IBUC • Updated transmit frequency plan information in Table 2.1 • Updated information about frequency bands in Appendix F |



This manual provides information about the Terrasat Communications, Inc. line of intelligent block upconverters (IBUCs) and transmit redundant systems.

Conventions and References

Before you start using this manual, it is important to understand the typographical conventions and terms used in the documentation.

[Table P.1](#) describes typographical conventions used in Terrasat Communications, Inc. documentation. For definitions of specialized terms used in the documentation, see [Appendix H, Glossary](#).

Table P.1 Typographical Conventions

| Convention | Description/Example |
|----------------------------------|---|
| Emphasis | Used to emphasize the importance of a point. The IP Address <i>must</i> be a unique number. |
| Internal cross-references | References to a section in the same document are marked in blue and are hyperlinked. See X-Band IBUC Export Regulations on page 1-5 . |
| Product and feature names | Named Terrasat products and features are identified on first use. ...line of intelligent block upconverters (IBUCs). |
| Technical Publication References | References to other Terrasat publications. If the reference is hyperlinked, it is also underscored. For detailed information, see the Terrasat Communications, Inc. IBUC Operations Manual . |
| User-entered values | A special font marks text that you type. At the password prompt, type <code>MyPassword</code> . |

Cautions and Warnings

| | |
|---|---|
|  | CAUTION |
| | <p>CAUTION indicates a hazardous situation that, if not avoided, could result in minor or moderate injury. CAUTION might also be used to indicate other unsafe practices or risks of property damage.</p> |

| | |
|---|---|
|  | HIGH VOLTAGE |
| | <p>HIGH VOLTAGE indicates the presence of a high-voltage hazard.</p> |

| | |
|---|--|
|  | WARNING |
| | <p>WARNING indicates a potentially hazardous situation that, if not avoided, could result in death or serious injury.</p> |

Trademarks

Other product names mentioned in this manual may be trademarks or registered trademarks of their respective companies and are hereby acknowledged.

Electrical Safety Notice

This equipment has been designed to minimize exposure of personnel to hazards. All operators and technicians must

- Know how to work around, with, and on high-voltage equipment.
- Exercise every precaution to ensure safety of personnel.
- Exercise extreme care when working near high voltages.
- Be familiar with the warnings in this manual.

INTRODUCTION

This manual is intended for users of Terrasat Communications, Inc. intelligent block upconverters (IBUCs) and associated transmit redundant systems.

Intelligent Block Upconverters

The C-band, X-band, Ku-band, DBS-band, and Ka-band IBUCs block upconvert an L-band intermediate frequency to one of five C-band uplink frequencies, one X-band uplink frequency, one of three Ku-band uplink frequencies, one of two DBS-band uplink frequencies, or one of two Ka-band frequencies. The rated power of the IBUC is specified at P1dB at the output waveguide flange or Type-N connector. The IBUC comes in a single weatherproof housing suitable for antenna or feedhorn mounting. See [Table 2.1 on page 2-2](#) for available frequency plans and power levels.

The term “intelligent” block upconverter refers to the advanced features and monitor and control capabilities of the IBUC product. The IBUC includes automatic gain control (AGC) and automatic level control (ALC) features as well as internal diagnostics. It also provides extensive monitoring and control through a menu of software commands and alarms providing access to the numerous operating parameters and features available in the unit. Access to features and monitor and control (M&C) functions is provided via several methods including a hand-held terminal, RS232, RS485, TCP/IP (Telnet, HTTP), UDP (SNMP) and FSK (frequency shift keying) link via the IFL cable. The IBUC is also fitted with a multifunction LED for visual status indications.

This manual provides information about:

- Installation, operation, and maintenance of IBUCs and transmit redundant systems.
- Use of user interface protocols for remote monitor and control capabilities of the IBUC and transmit redundant systems.

Reference Documents

Use the satellite operation standards listed in [Table 1.1](#) as reference documents.

Table 1.1 Satellite Operation Standards

| Earth Station Standards | |
|--------------------------------|---|
| Intelsat IESS 308/309 | Performance Characteristics for Intermediate Data Rate Digital Carriers Using Convolutional Encoding and QPSK Modulation |
| Eutelsat EESS 502 | Minimum Technical and Operational Requirements for Earth Stations Transmitting to a Eutelsat Transponder for Non-Standard Structured Types of SMS Transmissions. Standard M. |
| ETS 300-332 | Satellite Earth Stations (SES); Transmit-only or transmit-and-receive very small aperture terminals (VSATs) used for communications operating in the fixed satellite service (FSS) 6 GHz and 4 GHz frequency bands. |
| ETS 300-159 | Satellite Earth Stations (SES); Transmit/receive very small aperture terminals (VSATs) used for data communications operating in the fixed satellite service (FSS) 11/12/14 GHz frequency bands. |
| ETS 300-160 | Satellite Earth Stations (SES); Control and monitoring functions for very small aperture terminals (VSAT) networks. |
| ETSI EN 301 427 | Satellite Earth Stations and Systems (SES); Harmonized EN for Low Data Rate Mobile Satellite Earth Stations (MESs) except aeronautical mobile satellite earth stations, operating in the 11/12/14 GHz frequency bands covering essential requirements under article 3.2 of the Radio & Telecommunications Terminal Equipment (R&TTE) directive |
| ETSI EN 301 428 | Satellite Earth Stations and Systems (SES); Harmonized EN for Very Small Aperture Terminal (VSAT); Transmit-only, transmit/receive or receive-only satellite earth stations operating in the 11/12/14 GHz frequency bands covering essential requirements under article 3.2 of the Radio & Telecommunications Terminal Equipment (R&TTE) Directive. |
| ETSI EN 301 430 | Satellite Earth Stations and Systems (SES); Harmonized EN for Satellite News Gathering Transportable Earth Stations (SNG TES) operating in the 11-12/13-14 GHz frequency bands covering essential requirements under article 3.2 of the R&TTE directive |
| ETSI EN 301 443 | Satellite Earth Stations and Systems (SES); Harmonized EN for Very Small Aperture Terminal (VSAT); Transmit-only, transmit/receive, or receive-only satellite earth stations operating in the 4 GHz and 6 GHz frequency bands covering essential requirements under article 3.2 of the R&TTE Directive. |
| MIL-STD-188-164A with Change 3 | Interoperability of SHF Satellite Communications Terminals for tactical and long-haul communications. |
| Environmental Standards | |
| ETS 300 019-1-1 | Equipment Engineering (EE): Environmental Conditions and Environmental Tests for Telecommunications Equipment. Part 1-1: Classification of environmental conditions. Storage. |

Table 1.1 Satellite Operation Standards (Continued)

| Environmental Standards | |
|--------------------------------|---|
| ETS 300 019-1-2 | Equipment Engineering (EE): Environmental Conditions and Environmental Tests for Telecommunications Equipment. Part 1-2: Classification of environmental conditions. Transportation. |
| ETS 300 019-1-4 | Equipment Engineering (EE): Environmental Conditions and Environmental Tests for Telecommunications Equipment. Part 1-4: Classification of environmental conditions. Stationary use at non-weather protected locations. |
| ETS 300 019-2-1 | Equipment Engineering (EE): Environmental Conditions and Environmental Tests for Telecommunications Equipment. Part 2-1: Specification of environmental tests; Storage |
| ETS 300 019-2-2 | Equipment Engineering (EE): Environmental Conditions and Environmental Tests for Telecommunications Equipment. Part 2.2: Specification of environmental tests; Transportation |
| ETS 300 019-2-4 | Equipment Engineering (EE): Environmental Conditions and Environmental Tests for Telecommunications Equipment. Part 2-4: Specification of environmental tests; Stationary use at non-weather protected locations |
| EMC/EMI Standards | |
| 99/5/EEC | The Radio and Telecommunications Terminal Equipment Directive (R&TTE) |
| ETSI EN 301 489-1 v1.8.1 | Electromagnetic Compatibility and Radio Spectrum Matters (ERM); Electromagnetic Compatibility (EMC) standard for radio equipment and services; Part 1: Common technical requirements |
| ETSI EN 301 489-12 v2.2.2 | Electromagnetic Compatibility and Radio Spectrum Matters (ERM); Electromagnetic Compatibility (EMC) standard for radio equipment and services; Part 12: Specific conditions for Very Small Aperture Terminal, Satellite Interactive Earth Stations operated in the frequency ranges from 4 GHz through 30 GHz in the Fixed Satellite Services (FSS) |
| EN 55022A | Information Technology Equipment – Radio Disturbance Characteristics – Limits and methods of measurement |
| EN 61000-3-2 | Electromagnetic Compatibility (EMC) – Part 3.2: Limits for harmonic current emissions (equipment input current < 16 A per phase) |
| EN 61000-3-3 | Electromagnetic Compatibility (EMC) – Part 3.3: Limitation of voltage changes, voltage fluctuations, and flicker in public low-voltage supply systems for equipment with rated current ≤ 16 A per phase and not subject to conditional connection |
| EN 61000-4-2 | Electromagnetic Compatibility (EMC) – Part 4-2: Testing and measurement techniques – Electrostatic discharge immunity test |
| EN 61000-4-3 | Electromagnetic Compatibility (EMC) – Part 4-3: Testing and measurement techniques – Radiated, radio-frequency, electromagnetic field immunity test |
| EN 61000-4-4 | Electromagnetic Compatibility (EMC) – Part 4-4: Testing and measurement techniques – Electrical fast transient/burst immunity test |

Table 1.1 Satellite Operation Standards (Continued)

| EMC/EMI Standards | |
|--------------------------|--|
| EN 61000-4-5 | Electromagnetic Compatibility (EMC) – Part 4-5: Testing and measurement techniques – Surge immunity test |
| EN 61000-4-6 | Electromagnetic Compatibility (EMC) – Part 4-6: Testing and measurement techniques – Immunity to conducted disturbances, induced by radio-frequency fields |
| EN 61000-4-11 | Electromagnetic Compatibility (EMC) – Part 4-11: Testing and measurement techniques – Voltage dips, short interruptions, and voltage variations immunity tests |
| Safety Standards | |
| 2006/95/EC | The Low Voltage Directive (supersedes 73/23/EEC) |
| EN 60950-1 | Information technology equipment – Safety as applied to mains-powered or battery-powered information technology equipment, including electrical business equipment and associated equipment, with a rated voltage not exceeding 600 V. |

Warranty Information

Determination of warranty status of equipment shall be in accordance with the following Terrasat Communications, Inc. Warranty Policy.

(A) This warranty is for equipment of Terrasat Communications, Inc. The term “Terrasat” as used throughout this warranty shall mean Terrasat Communications, Inc., if the equipment was manufactured by Terrasat Communications, Inc.

(B) Terrasat warrants that its equipment shall be free from defects in material or workmanship at the time of shipment and that it will conform to applicable specifications.

For all Satcom products, the buyer shall exercise any and all warranty claims within a period of twenty-four (24) months.

- (1) The warranty does not apply to any part of a product if it has been altered, repaired, or misused in any way that, in the opinion of Terrasat, affects the reliability of, or detracts from the performance of any part of the product, or it is damaged as a result of the use of such part in or in connection with equipment not previously approved by Terrasat.
- (2) The warranty does not apply to any product or parts thereof if its serial number or the serial number of any of its parts has been altered, defaced, or removed.
- (3) The warranty does not cover damages or losses incurred in transport.
- (4) The warranty does not cover replacement or repair necessitated by loss or damage resulting from cases beyond the control of Terrasat.

(5) The warranty does not include the furnishing of any labor involved or connected with the removal and/or reinstallation of warranted equipment or parts on site, or any labor required to diagnose the necessity for replacement or repair.

(6) In no event shall Terrasat be liable to buyer for any indirect, special, or consequential damages or lost profits arising from the use of the equipment or products, even if Terrasat has been advised of the possibility thereof, or for any inability to use them either separated from or in combination with any other equipment or products.

(C) Terrasat's warranty, as stated herein, is in lieu of all other warranties, expressed, implied or statutory, including those of merchantability and fitness for a particular purpose, and Terrasat neither assumes nor authorizes any person to assume for it any other obligation or liability to any person in connection with the sale or use of Terrasat's products. The buyer shall pass on to any purchaser, lessee, or other user of Terrasat's products, the aforementioned warranty and shall indemnify and hold upon allegations that the buyer, its agents, or employees have made additional warranties or representations as to product preference or use.

(D) A fixed charge established for each product will be imposed for all equipment returned for warranty repair and where the cause of failure cannot be identified by Terrasat.

Note: Warranty seals are designed to break upon internal access. Access to the internal electronic components without prior written approval will void the warranty.

For more information about returning a product for repair, see [Repair Policy](#) on page 6-7.

X-Band IBUC Export Regulations

Under the Arms Export Control Act (AECA), 22 U.S.C. § 2778 (1994), the United States Department of State, Directorate of Defense Trade Controls (DDTC), implements the International Traffic In Arm Regulations (ITAR), 22 C.F.R. §§ 120-130, which control the export of defense articles and services from the United States to foreign destinations and persons.

Terrasat X-band IBUC products are subject to ITAR regulations administered by the U.S. State Department. Section 121.1 of the ITAR is the United States Munitions List (USML) and includes the commodities, related technical data, and defense services controlled for export purposes. The X-band IBUC is classified as USML Category XI(a)(5) "Command, control and communications systems to include radios (transceivers), navigation, and identification equipment." As indicated in the ITAR, items in this category are also designated "Significant Military Equipment (SME)." These products are not considered dual use as defined by the U.S. Commerce Department.

As ITAR-controlled items that are designated SME, each license application must be accompanied by Form DSP-83 identifying the end user and intermediate consignees. In addition, Exporters must ascertain the specific end user and end use prior to submitting a license application to the Directorate of Defense Trade Controls. Terrasat normally requests a separate letter to accompany the DSP-83 stating the type of terminal in which the IBUC will be used and the satellite system over which it will transmit.

Further, it is required that we inform the end user of the requirements of ITAR section 123.9, as follows:

The written approval of the Directorate of Defense Trade Controls must be obtained before reselling, transferring, transshipping, or disposing of a defense article to any end user, end use, or destination other than as stated on the export license.

Details of ITAR requirements can be found at the U.S. State Department Web site at <http://www.pmdtc.state.gov>.

ANATEL Compliance

In compliance with regulations set forth by the Brazilian National Telecommunications Agency (ANATEL), note the following:

“Este equipamento só pode ser utilizado no Brasil nas faixas de frequências e características técnicas descritas no Certificado de Homologação emitido pela Agência Nacional de Telecomunicações - ANATEL.”

Table 1.2 Transmissor para Estação Terrena - Categoria II

| Números de modelo na banda C | Números de modelo na banda Ku |
|------------------------------|-------------------------------|
| IBUC058064-1AC005 | IBUC137145-0AC004 |
| IBUC058064-1AC010 | IBUC137145-0AC008 |
| IBUC058064-1AC020 | IBUC137145-0AC012 |
| IBUC058064-1AC025 | IBUC137145-0AC016 |
| IBUC058064-1AC040 | IBUC137145-0AC020 |
| IBUC058064-1AC050 | IBUC137145-0AC025 |
| IBUC058064-1AC060 | IBUC137145-0AC030 |
| IBUC058064-1AC080 | IBUC137145-0AC040 |
| IBUC058064-147005C | IBUC137145-0AC050 |
| IBUC058064-147010C | IBUC137145-047004C |
| IBUC058064-147020 | IBUC137145-047008C |
| IBUC058064-147025C | IBUC137145-047012C |
| IBUC058064-147040 | IBUC137145-047016C |

Table 1.2 Transmissor para Estação Terrena - Categoria II (Continued)

| Números de modelo na banda C | Números de modelo na banda Ku |
|-------------------------------------|--------------------------------------|
| IBUC058064-147050 | IBUC137145-047020 |
| IBUC058064-147060 | IBUC137145-047025 |
| IBUC058064-147080 | IBUC137145-047030 |
| | IBUC137145-047040 |
| | IBUC137145-047050 |

Table 1.3 Conversor de Subida para Estação Terrena - Categoria II

| Números de modelo na banda C | Números de modelo na banda Ku |
|-------------------------------------|--------------------------------------|
| IBUC058064-1AC125 | IBUC137145-0AC060 |
| IBUC058064-1AC125I | IBUC137145-0AC060i |
| IBUC058064-1AC175 | IBUC137145-0AC080 |
| IBUC058064-1AC175I | IBUC137145-0AC080i |
| IBUC058064-1AC100 | |
| IBUC058064-1AC100I | |
| IBUC058064-1AC150 | |
| IBUC058064-1AC150I | |
| IBUC058064-1AC200I | |
| IBUC058064-1AC200I | |

This page intentionally left blank
for double-sided printing.

IBUC FUNCTIONAL DESCRIPTION

The Terrasat line of C-band, X-band, Ku-band, DBS-band, and Ka-band outdoor units (ODUs) consists of a range of intelligent block upconverters (IBUCs), power supply units (PSUIs), and low-noise block converters (LNBs) for use in satellite earth stations. The outdoor equipment is designed to interface directly with an L-band satellite modem.

System Components

The interfacility link (IFL) between the ODUs and the L-band modem uses 950 MHz to 2.0 GHz (L-band) as the interface frequency. This approach enables transmission and reception over the entire satellite band as opposed to a single transponder. The L-band IFL can also carry associated signals such as 10 MHz, DC voltage, or FSK which simplify installation and reduce costs. Terrasat IBUCs can be used for single channel per carrier/multiple channels per carrier (SCPC/MCPC), point-to-point, or point-to-multiple point network applications (such as voice, data, video, or IP services). All ODUs are weatherized and designed to mount outdoors in most climates, and on most satellite earth station antennas. See [Figure 2.9](#) to [Figure 2.12](#) on the following pages for typical equipment configurations.

The IBUC is available in a variety of frequency bands as shown in [Table 2.1 on page 2-2](#). The IBUC houses the IF interface (de-mux), the upconverter, the monitor and control (M&C) card, a DC-to-DC converter (if DC powered) and associated circuitry, an AC-to-DC converter (if AC powered), and a solid state power amplifier (SSPA) assembly. The IBUC can also house an optional internal 10 MHz reference signal module. Higher-power IBUCs also have an external cooling fan assembly. The input interface to the IBUC connects to a 50 Ω or an optional 75 Ω coaxial cable that carries the L-band transmit signal, and can carry the external 10 MHz reference oscillator signal, DC power, and bidirectional M&C FSK signals.

Table 2.1 Transmit Frequency Plans

| Signal | Standard C-band | Palapa C-band | Insat C-band | Extended C-band | Full C-band |
|---------------------|--|--|--|--|--|
| L-band | 950 MHz to 1525 MHz | 975 MHz to 1275 MHz | 1150 MHz to 1450 MHz | 950 MHz to 1750 MHz | 975 MHz to 1850 MHz |
| LO frequency | 7.375 GHz | 7.700 GHz | 8.175 GHz | 7.600 GHz | 7.700 GHz |
| RF frequency | 5.850 GHz to 6.425 GHz | 6.425 GHz to 6.725 GHz | 6.725 GHz to 7.025 GHz | 5.850 GHz to 6.650 GHz | 5.850 GHz to 6.725 GHz |
| Output Power | 5, 10, 20, 25, 40, 50, 60, 80, 100, 125, 150, 175, 200 watts | 5, 10, 20, 25, 40, 50, 60, 80, 100, 125, 150, 175, 200 watts | 5, 10, 20, 25, 40, 50, 60, 80, 100, 125, 150, 175, 200 watts | 5, 10, 20, 25, 40, 50, 60, 80, 100, 125, 150, 175, 200 watts | 5, 10, 20, 25, 40, 50, 60, 80, 100, 125, 150, 175, 200 watts |

| Signal | X-band | Standard Ku-band | Low Ku-band | Full Ku-band | DBS-band (Band 1) |
|---------------------|---|--|--|--|----------------------------|
| L-band | 950 MHz to 1450 MHz | 950 MHz to 1450 MHz | 950 MHz to 1450 MHz | 950 MHz to 1700 MHz | 950 MHz to 1750 MHz |
| LO frequency | 6.950 GHz | 13.050 GHz | 11.800 GHz | 12.800 GHz | 16.350 GHz |
| RF frequency | 7.900 GHz to 8.400 GHz | 14.000 GHz to 14.500 GHz | 12.750 GHz to 13.250 GHz | 13.750 GHz to 14.500 GHz | 17.300 GHz to 18.100 GHz |
| Output Power | 5, 10, 20, 25, 40, 50, 60, 80, 100, 125, 150, 175 watts | 4, 8, 12, 16, 20, 25, 30, 40, 50, 60, 80 watts | 4, 8, 12, 16, 20, 25, 30, 40, 50, 60, 80 watts | 4, 8, 12, 16, 20, 25, 30, 40, 50, 60, 80 watts | 5, 8, 10, 16, 20, 25 watts |

| Signal | DBS-band (Band 2) | Ka-band (Band 1) | Ka-band (Band 2) |
|---------------------|----------------------------|--------------------------|--------------------------|
| L-band | 1150 MHz to 1450 MHz | 1000 MHz to 1500 MHz | 1000 MHz to 2000 MHz |
| LO frequency | 16.950 GHz | 28.500 GHz | 29.000 GHz |
| RF frequency | 18.100 GHz to 18.400 GHz | 29.500 GHz to 30.000 GHz | 30.000 GHz to 31.000 GHz |
| Output Power | 5, 8, 10, 16, 20, 25 watts | 5, 10, 16, 20, 25 watts | 5, 10, 16, 20, 25 watts |

DC Supply

For lower power units (such as the Ku-band 16 watt and below, C-band 25 watt and below, X-band 20 watt and below, DBS-band 8 watt and below, Ka-band 10 watt and below), DC power can be supplied through the N-connector or F-connector (labeled J1) of the L-band input or through the external power connector (labeled J3). DC power for the high-power units is supplied through the six-pin circular connector (labeled J3) of the DC input. Higher-power units (such as Ku-band 20 watt and higher, C-band 40 watt and higher, X-band 25 watt and higher, DBS-band 10 watt and higher, or Ka-band 16 watt and higher) cannot accept DC input through the L-band input connector due to the higher current draw. In all cases, the DC power input source is sensed and protected automatically so that an input to one connector does not result in an output to the other connector. If, for some reason, a DC power source is applied to both connectors simultaneously, the internal protection circuitry prioritizes which DC power source will be used. The priority connector is the six-pin circular connector (labeled J3) of the DC input.

Terrasat IBUCs have several supply voltage options. The standard configuration is 48 VDC. However, a 24 VDC option is available for lower power units. Refer to the datasheets in [Appendix G](#) for more information. This choice of 24 VDC or 48 VDC is available only when the IBUC is ordered and configured at the factory. The operating voltage range for the 24 VDC option is 20 VDC to 28 VDC. The operating voltage range for lower-power units with 48 VDC is 37 VDC to 60 VDC; however, for higher-power units with the 48 VDC option (such as the C-band 100 watt and above, X-band 100 watt and above, and the Ku-band 60 watt and above) the operating range is 42 VDC to 60 VDC. Units operating at 48 VDC are configured at the factory to be floating.

AC Supply

IBUCs are available with optional AC power. [Table 2.2](#) lists the voltage ranges for different bands and power levels.

Table 2.2 AC Supply Operating Voltage Ranges

| Voltage | Band | Watts |
|--------------------|----------|----------------------|
| 100 VAC to 240 VAC | C-band | 5 watt to 125 watt |
| 200 VAC to 240 VAC | C-band | 150 watt to 200 watt |
| 100 VAC to 240 VAC | X-band | 5 watt to 125 watt |
| 200 VAC to 240 VAC | X-band | 150 watt to 175 watt |
| 100 VAC to 240 VAC | Ku-band | 4 watt to 80 watt |
| 100 VAC to 240 VAC | DBS-band | 5 watt to 25 watt |
| 100 VAC to 240 VAC | Ka-band | 5 watt to 25 watt |

Fuses

Table 2.3 lists the the fuse markings of the fuses required by different AC-powered IBUC models. defines the international marking schema.

Table 2.3 Fuse Markings

| | | Fuse Markings | |
|--------------------------|-------|---------------|-------------|
| | | 115 VAC | 230 VAC |
| C-band | 5 W | T1.6AL250V | T1.6AL250V |
| | 10 W | T2AL250V | T1.6AL250V |
| | 20 W | T3.15AL250V | T1.6AL250V |
| | 25 W | T4AL250V | T2AL250V |
| | 40 W | T6.3AL250V | T3.15AL250V |
| | 50 W | T6.3AL250V | T3.15AL250V |
| | 60 W | T8AL250V | T4AL250V |
| | 80 W | T10AL250V | T5AL250V |
| C-band High Power | 100 W | T12.5AL250V | T6.3AL250V |
| | 125 W | T12.5AL250V | T6.3AL250V |
| | 150 W | n/a | T10AL250V |
| | 175 W | n/a | T10AL250V |
| | 200 W | n/a | T10AL250V |
| X-band | 5 W | T1.6AL250V | T1.6AL250V |
| | 10 W | T2.5AL250V | T1.3AL250V |
| | 20 W | T3.15AL250V | 1.6AL250V |
| | 25 W | T4AL250V | T2AL250V |
| | 40 W | T6.3AL250V | T3.15AL250V |
| | 50 W | T8AL250V | T4AL250V |
| | 60 W | T10AL250V | T5AL250V |
| | 80 W | T10AL250V | T5AL250V |
| X-band High Power | 100 W | T12.5AL250V | T6.3AL250V |
| | 125 W | T12.5AL250V | T6.3AL250V |
| | 150 W | n/a | T10AL250V |
| | 175 W | n/a | T10AL250V |
| Ku-band | 4 W | T1.6AL250V | T1.6AL250V |
| | 8 W | T2.5AL250V | T1.6AL250V |
| | 12 W | T2.5AL250V | T1.6AL250V |
| | 16 W | T3.15AL250V | T1.6AL250V |
| | 20 W | T4AL250V | T2AL250V |
| | 25 W | T5AL250V | T2.5AL250V |

Table 2.3 Fuse Markings (Continued)

| | | Fuse Markings | |
|---------------------------|------|---------------|-------------|
| | | 115 VAC | 230 VAC |
| Ku-band | 30 W | T8AL250V | T4AL250V |
| | 40 W | T8AL250V | T4AL250V |
| | 50 W | T10AL250V | T5AL250V |
| Ku-band High Power | 60 W | T12.5AL250V | T6.3AL250V |
| | 80 W | T12.5AL250V | T6.3AL250V |
| DBS-band | 5 W | T2.5AL250V | T1.6AL250V |
| | 8 W | T3.15AL250V | T1.6AL250V |
| | 10 W | T4AL250V | T2AL250V |
| | 16 W | T4AL250V | T2AL250V |
| | 20 W | T5AL250V | T2.5AL250V |
| | 25 W | T5AL250V | T2.5AL250V |
| Ka-band | 5 W | T2AL250V | T1.6AL250V |
| | 10 W | T3.15AL250V | T1.6AL250V |
| | 16 W | T6.3AL250V | T3.15AL250V |
| | 20 W | T6.3AL250V | T1.6AL250V |
| | 25 W | T8AL250V | T4AL250V |

For IBUCs that require fuses up to 6.3 A, Terrasat recommends time lag fuses with a high I^2t value.

For IBUCs that require fuses greater than 6.3 A, Terrasat recommends time lag fuses.

For reference, the IBUCs are delivered with Littelfuse 213 Series fuses (surge withstand, time lag for up to 6.3 A) or 218 Series fuses (time lag for greater than 6.3 A).

[Table 2.4](#) explains the fuse marking schema.

Table 2.4 Fuse Markings Explained

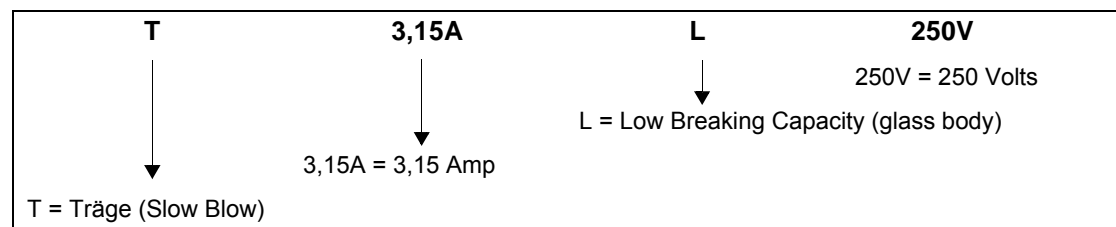

Figure 2.1 depicts the front panel of a DC-powered IBUC and the locations of the J1, J2, and J3 connectors. This model IBUC does not have an external fan as is typical of C-band IBUCs up to 10 watts, X-band IBUCs up to 10 watts, Ku-band IBUCs up to 8 watts, 5 watt DBS-band IBUCs, and 5 watt Ka-band IBUCs.



Figure 2.1 Front Panel of a DC-powered IBUC Without an External Fan

Figure 2.2 depicts the front panel of an AC-powered IBUC and the locations of the J1, J2, and J3 connectors, as well as the F1 and F2 fuse holders. This model IBUC does not have an external fan as is typical of C-band IBUCs up to 10 watts, X-band IBUCs up to 10 watts, Ku-band IBUCs up to 8 watts, 5 watt DBS-band IBUCs, and 5 watt Ka-band IBUCs.

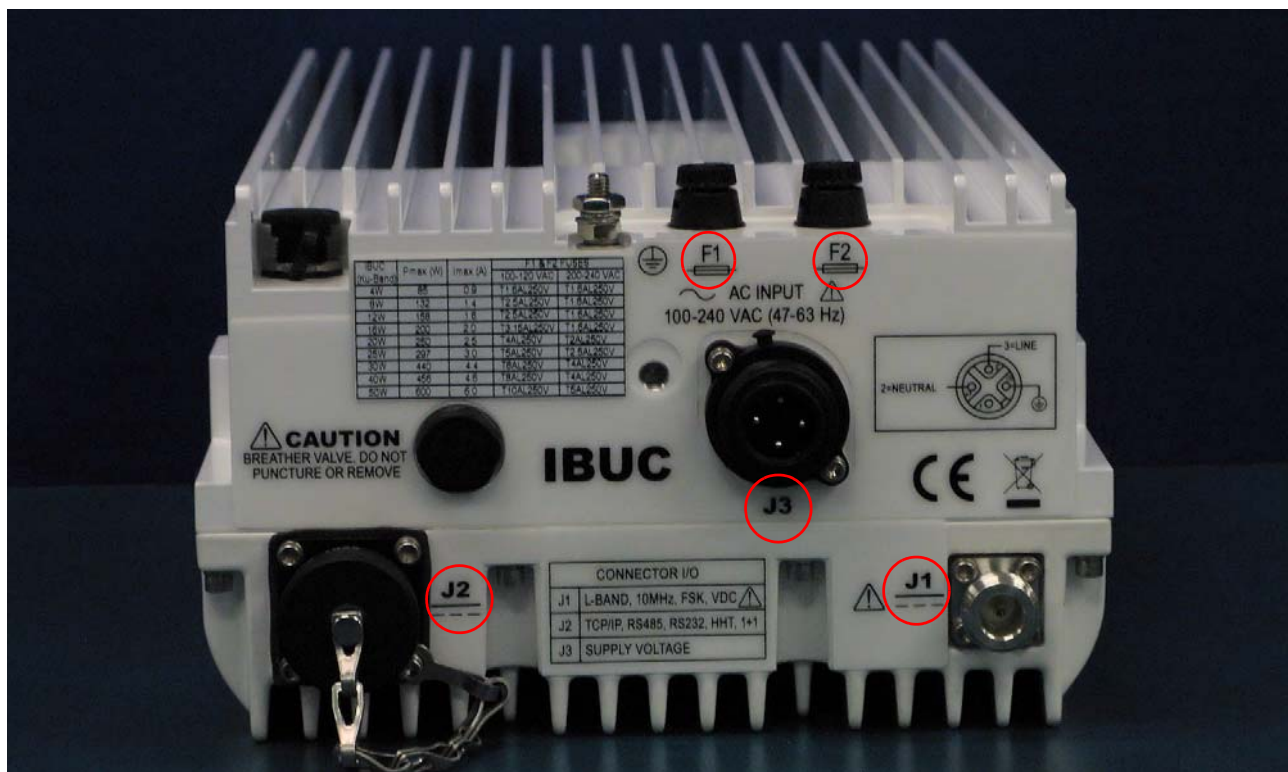

Figure 2.2 Front Panel of an AC-powered IBUC Without an External Fan

Figure 2.3 depicts the front panel of a DC-powered IBUC with a fan shroud and the locations of the J1, J2, and J3 connectors. The external fan is typically found in C-band IBUCs from 20 watts to 80 watts, X-band IBUCs from 20 watts to 80 watts, Ku-band IBUCs from 12 watts to 50 watts, DBS-band IBUCs from 8 watts to 25 watts, or Ka-band IBUCs from 10 watts to 25 watts.



Figure 2.3 Front Panel of a DC-powered IBUC With an External Fan

Figure 2.4 depicts the front panel of an AC-powered IBUC with a fan shroud and the locations of the J1, J2, and J3 connectors, as well as the locations of the F1 and F2 fuse holders. The external fan is typically found in C-band IBUCs from 20 watts to 80 watts, X-band IBUCs from 20 watts to 80 watts, Ku-band IBUCs from 12 watts to 50 watts, DBS-band IBUCs from 8 watts to 25 watts, or Ka-band IBUCs from 10 watts to 25 watts.

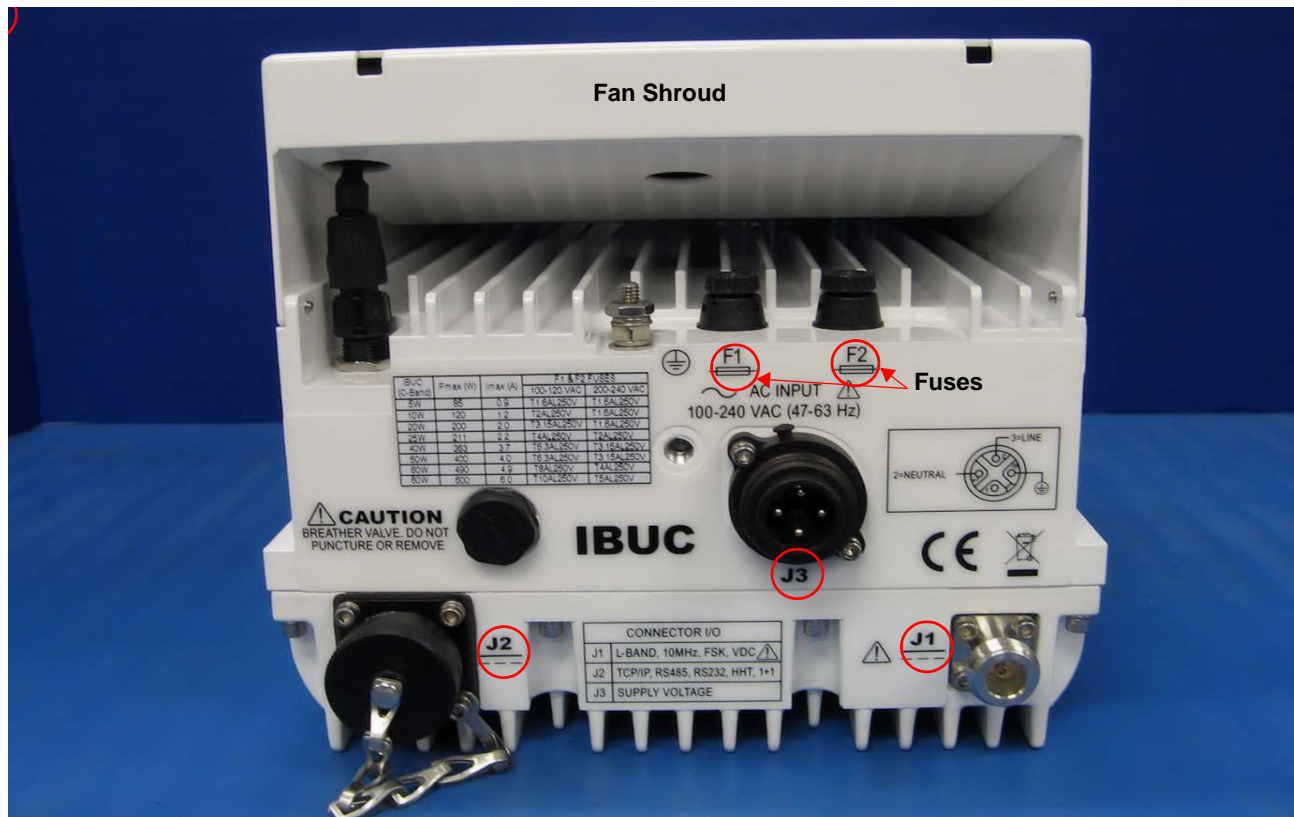

Figure 2.4 Front Panel of an AC-powered IBUC With an External Fan

Figure 2.5 depicts the front panel of a DC-powered high-power IBUC and the locations of the J1, J2, and J3 connectors. This front panel is typically found on C-band IBUCs from 100 watts to 200 watts, X-band IBUCs from 100 watts to 175 watts, or Ku-band IBUCs from 60 watts to 80 watts.

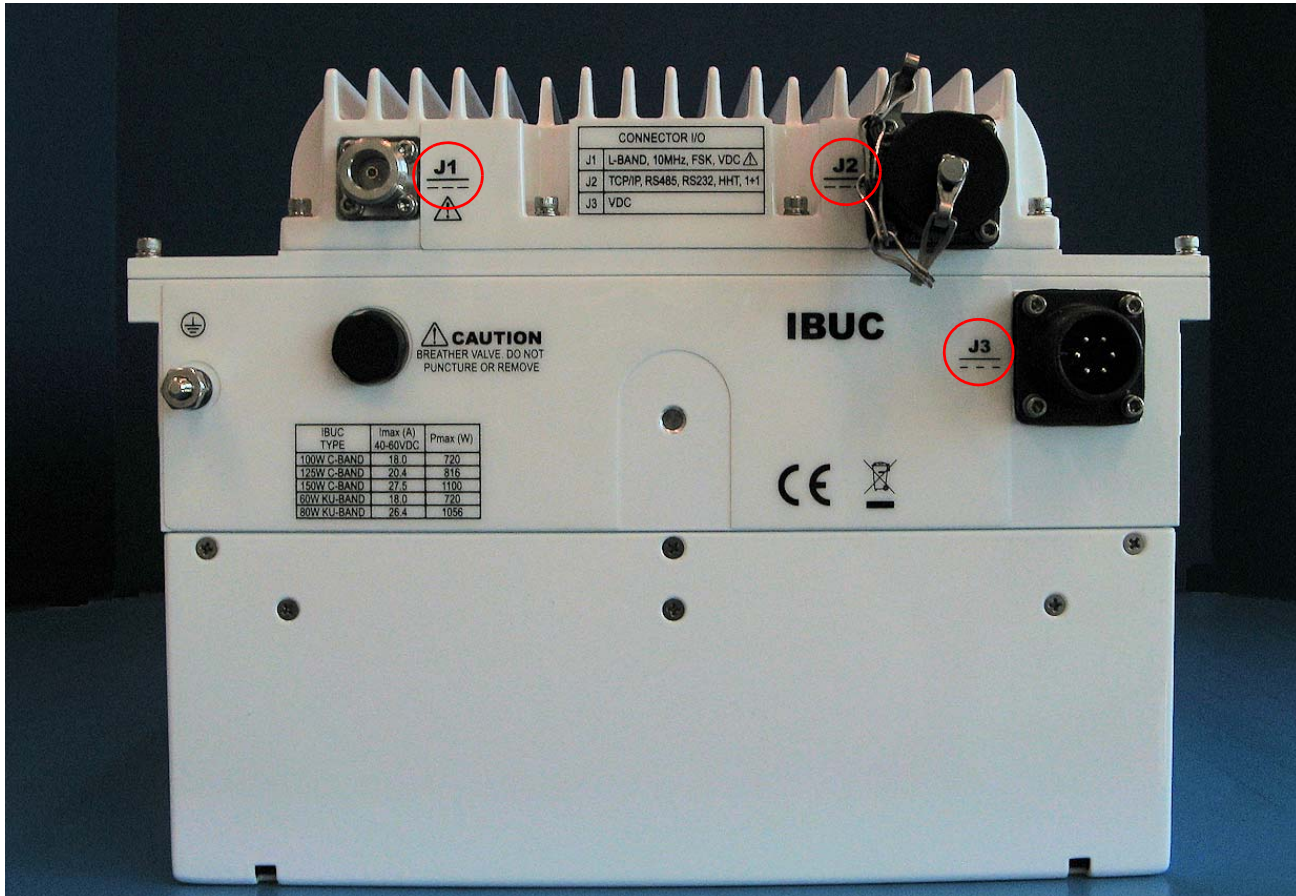

Figure 2.5 Front Panel of a DC-powered High-Power IBUC

Figure 2.6 depicts the front panel of an AC-powered high-power IBUC and the locations of the J1, J2, and J3 connectors, as well as the locations of the F1 and F2 fuse holders. This front panel is typically found on C-band IBUCs from 100 watts to 200 watts, X-band IBUCs from 100 watts to 175 watts, or Ku-band IBUCs from 60 watts to 80 watts.



Figure 2.6 Front Panel of an AC-powered High-Power IBUC

Monitor and Control

The IBUC is equipped with extensive monitor and control (M&C) capabilities. Use any of the following methods to access those capabilities:

- Via the M&C 19-pin circular connector (J2) utilizing two-wire RS485. This method requires that a separate cable must be run and connected to J2.
- Via the J2 connector using RS232. This method requires that a separate cable must be run and connected to J2.

Figure G.1 on page G-2 contains a drawing for fabricating your own cable.

- Via the J2 connector using TCP/IP. This method requires a separate Ethernet cable.

Figure G.2 on page G-3 contains a drawing for fabricating your own cable.

- Via the J2 connector using an optional hand-held terminal. The hand-held terminal has its own cable.
- Via the L-band input N-connector or F-connector (J1) utilizing frequency shift keying (FSK). Using this method requires no additional cable(s) but does require that the FSK be multiplexed onto the L-band cable.

Note: Some modem manufacturers offer built-in FSK capabilities for communicating with the IBUC through the L-band IFL. Refer to the modem manufacturer’s documentation for more information.

RF Signal Flow

L-band input to the IBUC is through the input N-connector or the F-connector (labeled J1). Required inputs include an L-band signal at -20 dBm or less and a 10 MHz sine wave reference signal between +5 dBm and -12 dBm (for those units that do not have the optional internal 10 MHz reference signal). The internal 10 MHz reference signal meets the minimum phase noise requirements listed in [Table 2.5](#).

Note: If an external 10 MHz reference signal is applied to a unit with the optional internal 10 MHz reference signal, the external signal has priority. When the external signal is removed from such units, the system automatically reverts to the internal 10 MHz signal, requiring no additional user input.

Table 2.5 Internal 10 MHz Reference Signal Parameters

| | Minimum | Maximum | Condition |
|---|----------|-------------|------------------|
| Phase Noise | | -100 dBc/Hz | 10 Hz |
| | | -130 dBc/Hz | 100 Hz |
| | | -140 dBc/Hz | 1 kHz |
| | | -145 dBc/Hz | 10 kHz |
| Frequency Stability vs. Operating Temperature Range (referenced to frequency at +25 °C) | -100 ppb | +100 ppb | -40 °C to +85 °C |
| Tuning Range (referenced to nominal frequency) | ±3 ppm | ±10 ppm | |
| Tuning Slope | Positive | | |

Input to the IBUC also includes AC or DC voltage (via the J3 connector) and DC voltage for low-power units and an FSK signal via the J1 connector. The input (L-band, FSK, 10 MHz, and DC via coaxial cable) is routed to the demultiplexer circuitry where the various signals are split off and routed to the appropriate circuits within the IBUC. (Only IBUCs with direct DC or AC via the J3 connector feed the power supply directly.) The input voltage from the demultiplexer circuitry is routed to the power supply and the FSK signal is routed to the M&C card.

The external 10 MHz reference signal is routed to the multiplier circuitry where its level is first detected and an alarm issued if the signal is low. However, if the signal level is low and the system is equipped with the optional internal 10 MHz signal, the system will automatically switch to the internal 10 MHz signal. The 10 MHz signal is then multiplied to the frequency used for phase-locking purposes. The output of the multiplier is routed to the phase detector circuitry where it is compared with the phase of the DRO (dielectric resonator oscillator) signal sample and consequently generates a voltage that is applied as a control voltage to the DRO to adjust its frequency. The DRO has been optimized for phase noise at a single frequency based on the frequency band of that particular IBUC. The output of the DRO is amplified and routed to the mixer.

The L-band signal that is split off in the demultiplexer circuitry is first filtered and a sample of it detected for input power detection and control purposes. The signal is then amplified, and goes through two sections of variable attenuators. The first section of attenuation is used to provide the user with an attenuation adjustment of 16 dB in 0.1 dB steps. The second section of attenuation is used to provide automatic level control (ALC) or automatic gain control (AGC).

After additional amplification and filtering, the signal is routed to the mixer. The L-band signal is then mixed with the DRO signal to “upconvert” to the appropriate RF signal based on the frequency band of the IBUC. The RF signal is filtered, amplified, and then routed to the temperature compensation circuitry. The temperature compensation circuitry has been calibrated so that the IBUC gain does not vary more than 3 dB at any given frequency.

Note: Some units can vary up to 4 dB at any given frequency.

The signal is then routed through an isolator to the solid-state power amplifier (SSPA). The SSPA amplifies the signal which is then routed to the output through an isolator for reverse power protection. The RF output is detected for M&C purposes. The IBUC gain has been calibrated so that at minimum attenuation, a -30 dBm input results in rated power of at least P1dB at the output at any frequency or temperature. To operate at lower power levels, reduce the input to the IBUC or reduce the IBUC gain by using the variable attenuator, accessible using any of the M&C interfaces. The output of a C-band IBUC is a WR137G waveguide or an N-type connector, the output of an X-band is a CP112G waveguide, the output of a Ku-band IBUC is a WR75 cover with groove waveguide, the output of a DBS-band IBUC is a WR62 cover with groove waveguide, and the output of a Ka-band IBUC is a WR28 UG cover with groove waveguide.

[Figure 2.7](#) depicts the signal flow for units that are DC powered and [Figure 2.8](#) depicts the signal flow for units that are AC powered.

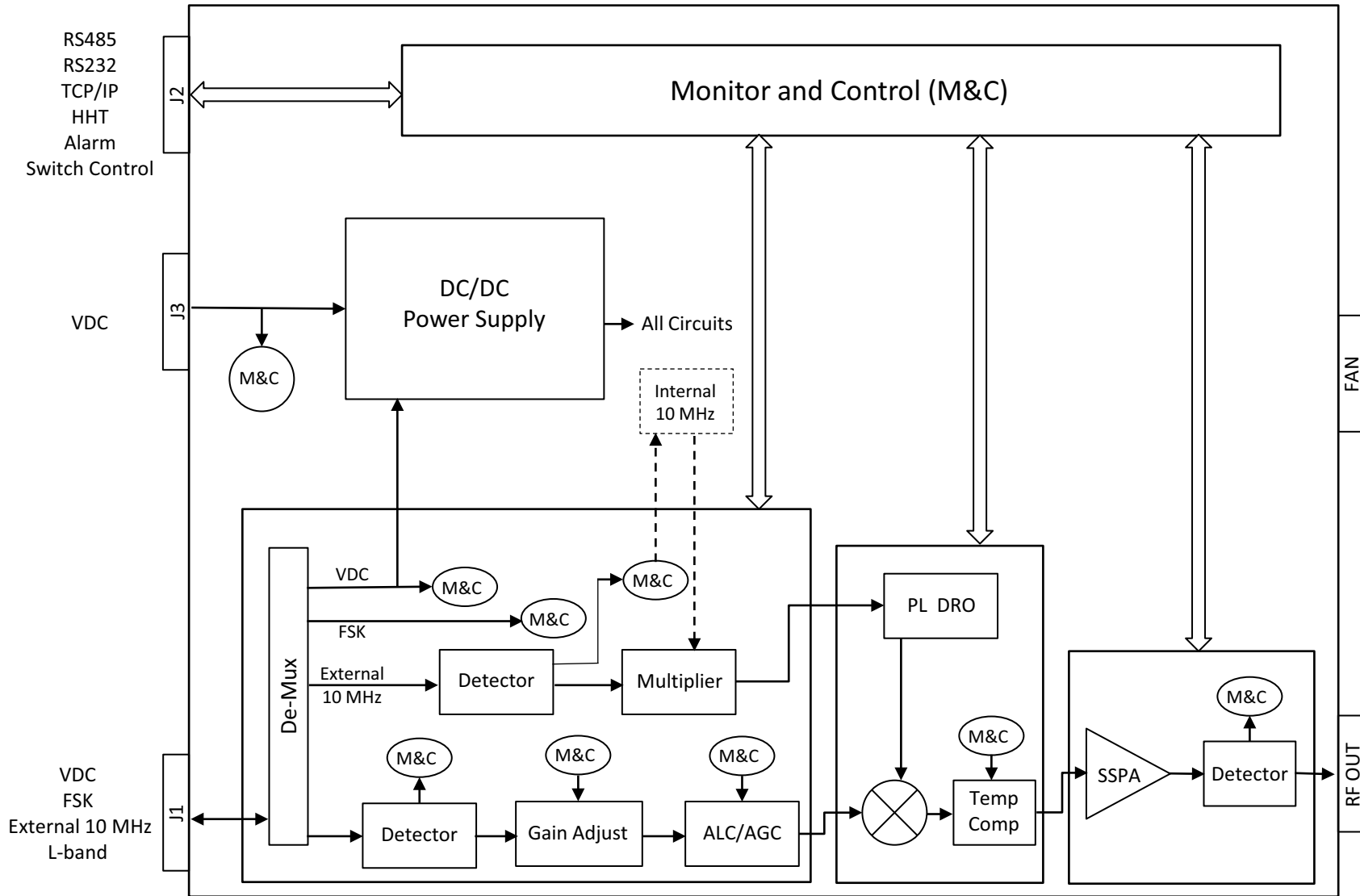

Figure 2.7 IBUC Block Diagram (for DC-powered units)

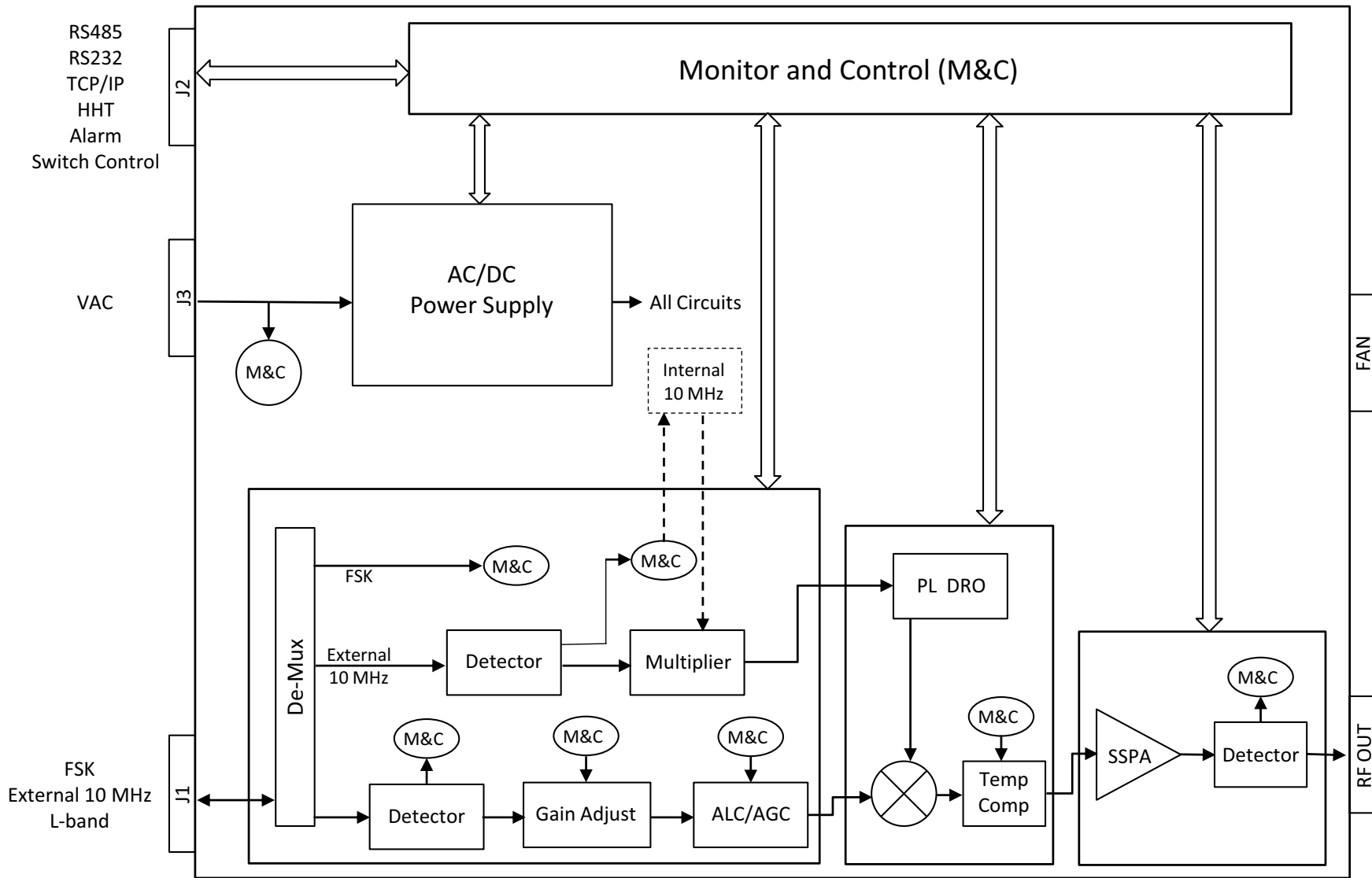

Figure 2.8 IBUC Block Diagram (for AC-powered units)

Software

The IBUC monitors and controls numerous parameters and has features which simplify installation and use of the IBUC and enhance system performance.

Some of these key features include:

- Monitor and Control

The IBUC can be monitored and controlled through an assortment of interfaces including RS232, RS485, Ethernet port, an optional hand-held terminal or via an FSK link with compatible modems. The FSK link is multiplexed on the L-band IFL thus eliminating the need for an additional cable and simplifying installation. See [Chapter 5, Monitor and Control Features and Functions](#), for a full description of these functions.

- Tx Attenuation

The gain of the unit can be set over a 16 dB range in 0.1 dB steps.

- Automatic Gain Control (AGC)

The IBUC continuously monitors input and output levels. When AGC is enabled, the gain of the system is maintained at a constant level by an internal algorithm. Gain is the difference between output power and input power.

- Automatic Level Control (ALC)

Similar to the AGC system, when ALC is enabled, the gain is adjusted to maintain a constant output level.

- Redundancy

The IBUC senses automatically when configured as a redundant system. This logic is built-in—eliminating the need for an external switching controller.

- Embedded Web Pages

Provides management for small networks by using a Web browser.

- Simple Network Management Protocol (SNMP)

Provides integration of IP M&C in existing network management systems.

- Burst Operation

Enables operation in burst mode. The IBUC reports average output power of valid bursts (above a burst threshold) when in burst mode.

- Alarm History (with time stamps)

A log of alarms that occur is maintained. This can simplify troubleshooting of the system (especially when an intermittent problem occurs).

- Sensors

A series of internal sensors enable you to verify performance and to troubleshoot the system. Sensors include internal temperature, 10 MHz input detector, supply voltage, current consumption, phase-locked dielectric resonator oscillator (PLDRO) lock voltage, input level and output level.

System Configurations

Figure 2.9 through Figure 2.12 show typical earth station installations using Terrasat block upconverters. In normal operation, the IBUC and the low-noise block downconverter (LNB) are mounted outdoors. Depending on the model of the IBUC, the PSUI can be mounted indoors or outdoors. The IBUC and the LNB can interface directly with a satellite modem, a 70 MHz to L-band rack converter, a modem combiner network, or an interface unit (IFU). Table 2.6 lists the requirements for proper operation.

Table 2.6 Basic System Requirements

| IBUC | LNB |
|----------------------------|-------------------------|
| DC supply | DC supply |
| ~ from the modem | ~ from the modem |
| ~ from the IFU | ~ from the IFU |
| ~ from the outdoor PSUI | 10 MHz reference signal |
| ~ from the indoor PSUI | ~ from the modem |
| ~ from the telecom station | ~ from the IFU |
| AC supply | ~ internally referenced |
| ~ AC mains | RF input |
| 10 MHz reference signal | ~ from the antenna |
| ~ from the modem | |
| ~ from the IFU | |
| ~ internally referenced | |
| L-band signal | |

Certain considerations must be made when selecting the IFL because appropriate shielding and signal levels are required for normal system operation. The IBUC is designed to operate with a -30 dBm Tx L-band input signal to achieve rated power at maximum gain/minimum attenuation. The IBUC provides a variable attenuator that is

accessible through the various M&C interfaces that enables the gain of the unit to be reduced by up to 16 dB in 0.1 dB steps. The attenuator can be used to prevent overdrive to the IBUC in configurations with a short cable run (or IFL), thus preserving the dynamic range of the modem. In addition, the IBUC and LNB must have a 10 MHz input signal at +5 dBm to -12 dBm for the IBUC, and 0 dB to -10 dBm for the LNB. The maximum voltage drop for a 24 VDC IBUC is 4 volts and the maximum drop for a 48 VDC IBUC is 11 volts. For AC-powered IBUCs, the range is 100 VAC to 240 VAC; however, for IBUCs that operate at higher power (for example, 150 watt to 200 watt C-band), the range is 200 VAC to 240 VAC.

Note: The system configurations in [Figure 2.9](#) through [Figure 2.12](#) depict an external 10 MHz reference signal; however, an optional internal 10 MHz reference signal is available.

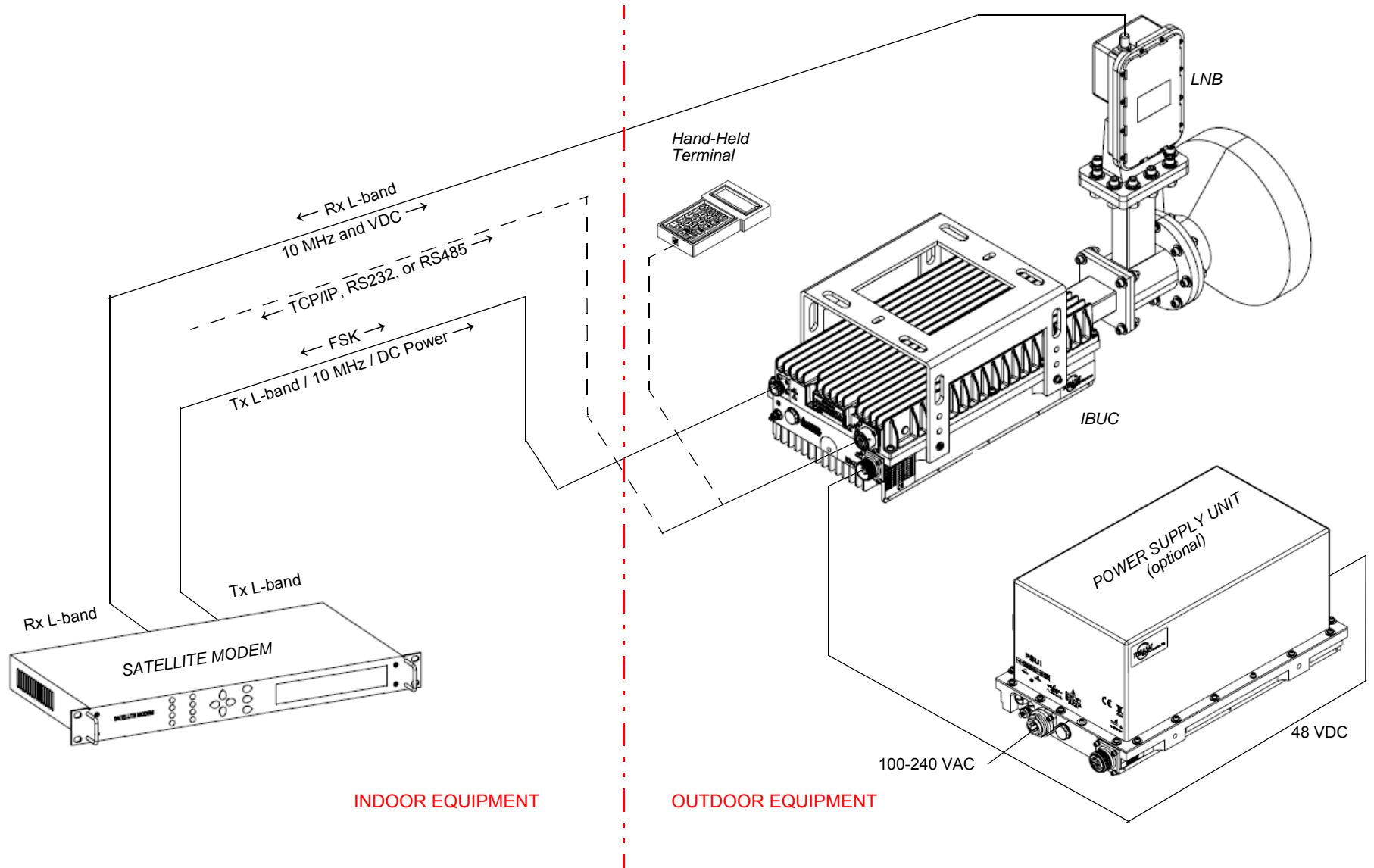

Figure 2.9 Low-Power System Configuration

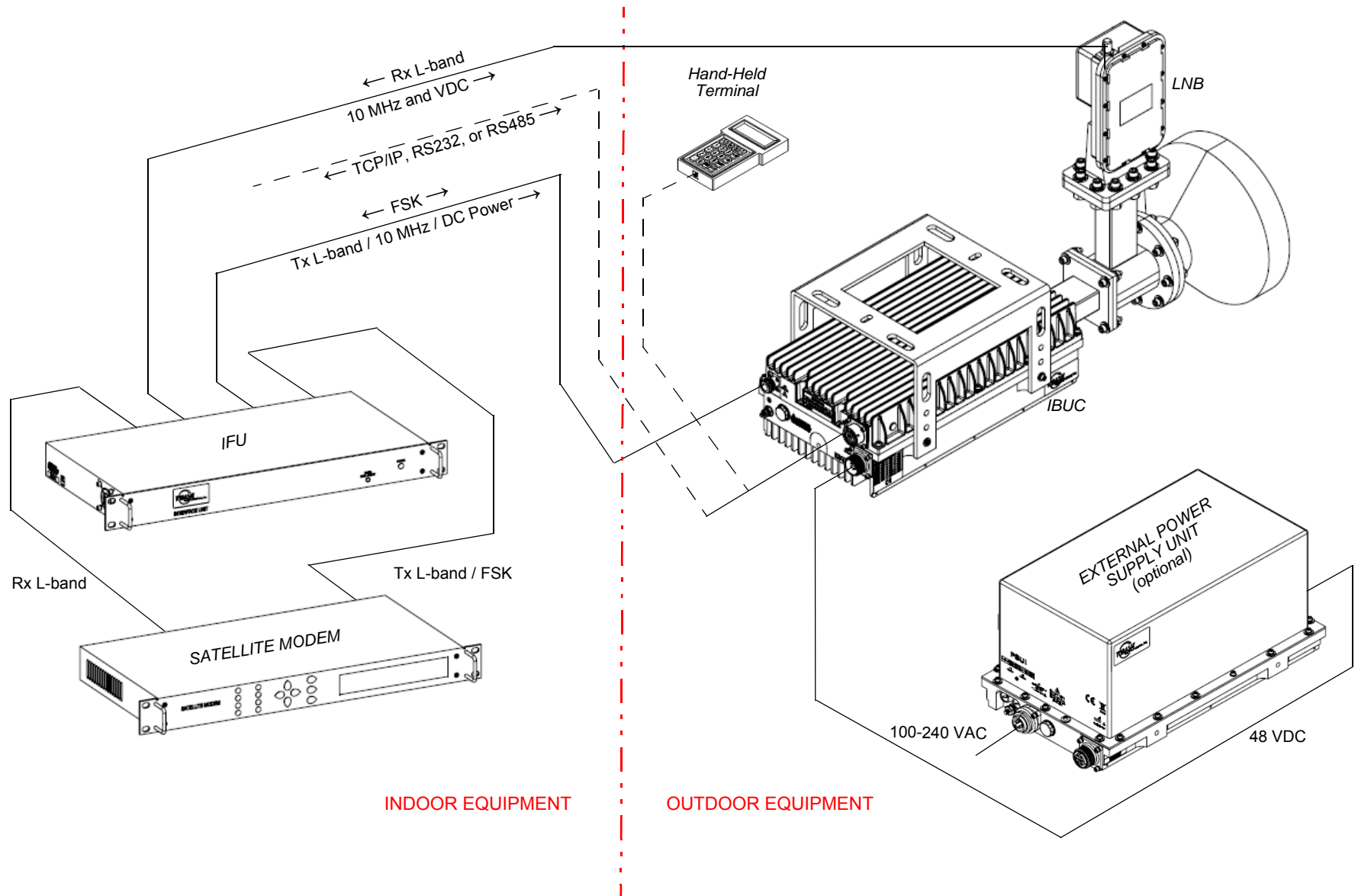

Figure 2.10 Low-Power System Configuration with IFU

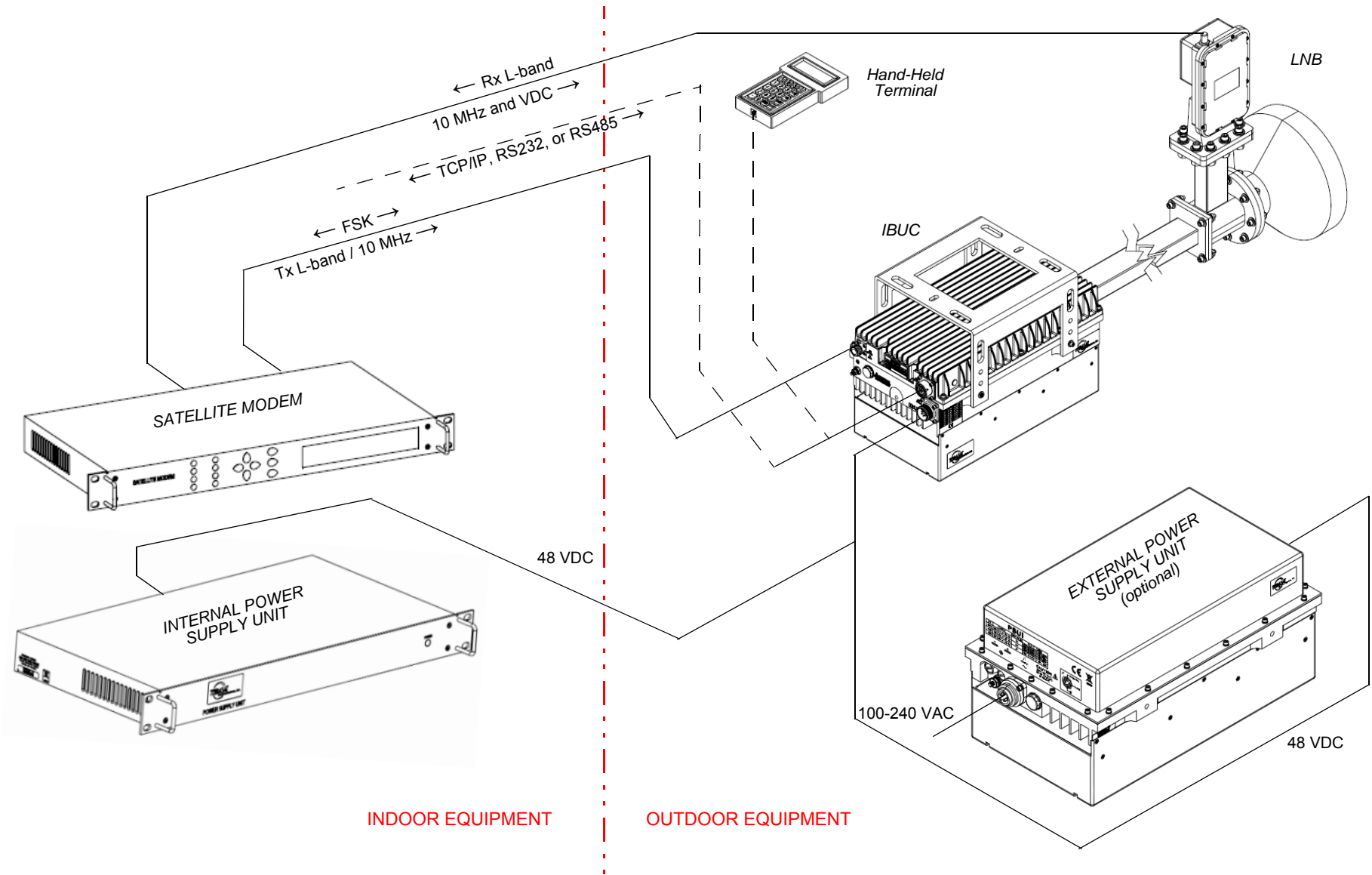

Figure 2.11 High-Power System Configuration

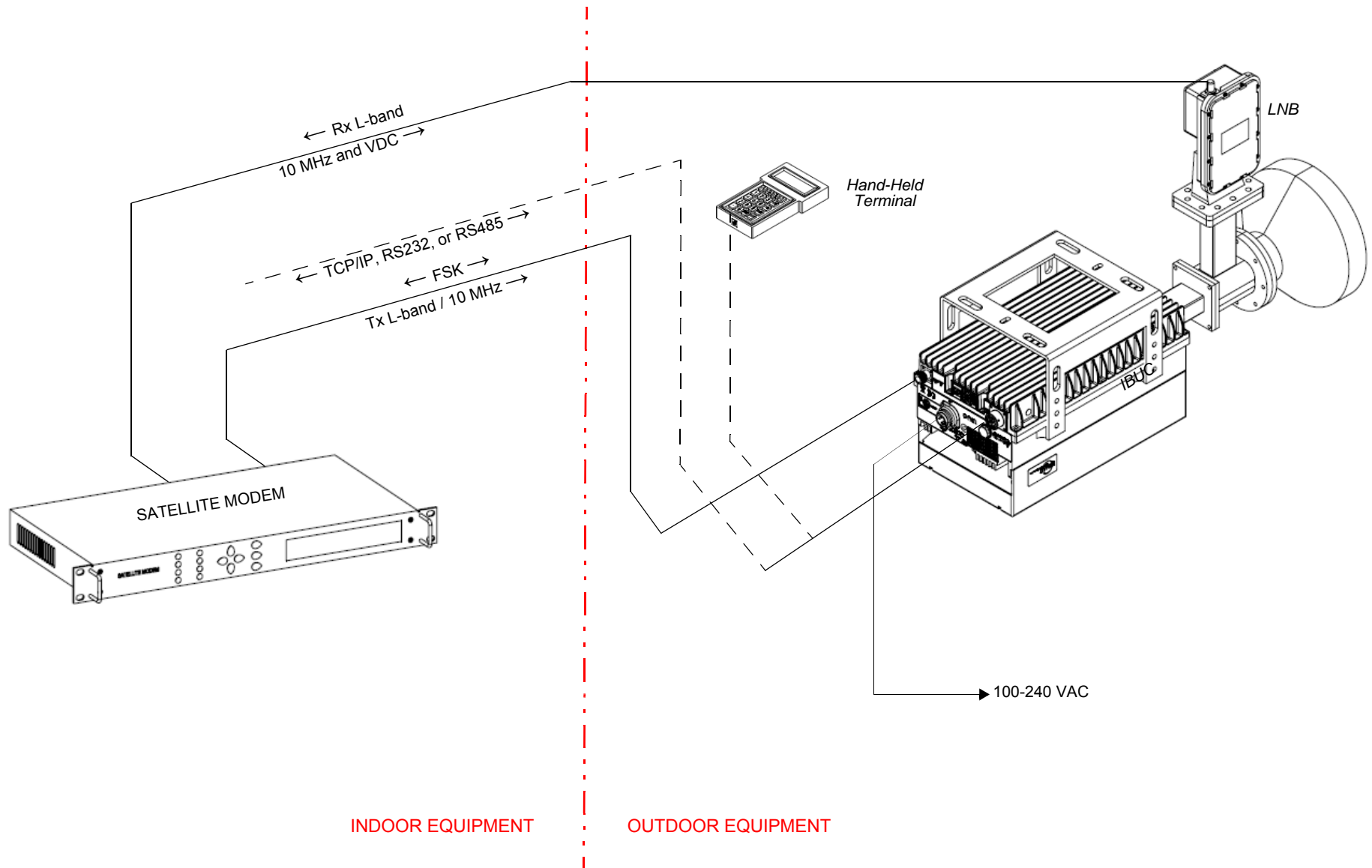

Figure 2.12 AC Power System Configuration

Storage Information

There are no storage limitations on the IBUC or 1+1 interfaces for redundant systems other than avoiding excessive exposure beyond the -45 °C to +85 °C external ambient temperature.

This page intentionally left blank
for double-sided printing.

IBUC INSTALLATION

This chapter contains the general requirements for installing the outdoor unit (ODU). The ODU consists of an intelligent block upconverter (IBUC) and a low-noise block converter (LNB). An indoor interface unit (IFU) and a power supply unit (PSUI) can also be part of the configuration. The ODU can be installed near the feedhorn of the antenna, on the boom arm, on the antenna's back structure, or in the antenna hub.

General Requirements



WARNING

For protection of personnel and equipment, use care when installing the antenna and whenever working on or around the system.

Follow standard safety precautions with hand and/or power tools.

Use care in working with high AC voltages and microwave emissions.

Unpacking

Check to make sure that the ODU has not suffered damage in shipment. If there is any damage, contact the shipper before proceeding. If you need to declare any equipment as damaged during transit, save the original shipping cartons to facilitate inspection reporting.

Compare the contents of the shipping container with the packing list to ensure all items have been received. If any item is missing, contact Terrasat.

Terrasat recommends retaining and re-using all shipping cartons and foam forms if the equipment will be stored or reshipped. The cartons should be clearly marked to indicate that they contain fragile electronic equipment.

| | |
|---|---|
|  | CAUTION |
| | IBUCs can weigh as much as 32 lb (14.5 kg). Use care when lifting Terrasat equipment to avoid physical injury. |

Furnished Items

The following items are furnished with Terrasat Communications, Inc. IBUCs:

- A C-band, X-band, Ku-band, DBS-band, or Ka-band IBUC with an integrated solid state power amplifier (SSPA)
- Product documentation CD
- Waveguide gaskets and hardware (waveguide units only)
- Test datasheet
- Monitor and Control (M&C) mating connector
- DC supply mating connector (for units with -48 VDC supply)
- AC supply mating connector (for units with AC supply)
- Snap-on ferrite core

The ferrite core and accompanying mastic tape are to be used when fabricating a supply cable using the provided connectors.

- Sealing tape for Type-N connector
- Fuses

The fuses are intended for 220 VAC operation and are supplied only with units that operate over the range of 100 VAC to 240 VAC.

- 5 g pouch of Permatex anti-seize lubricant

The anti-seize lubricant is a heavy duty high-temperature lubricant that prevents galling, seizing, and corrosion of fasteners during assembly and facilitates disassembly of parts exposed to heat or corrosive environments.

- Rx reject filter and hardware (full Ku- and X-band; X-band filter is optional)
- Mounting bracket and bolts (optional)

Figure 3.1 illustrates the contents of the shipping carton of an IBUC as it leaves the factory.

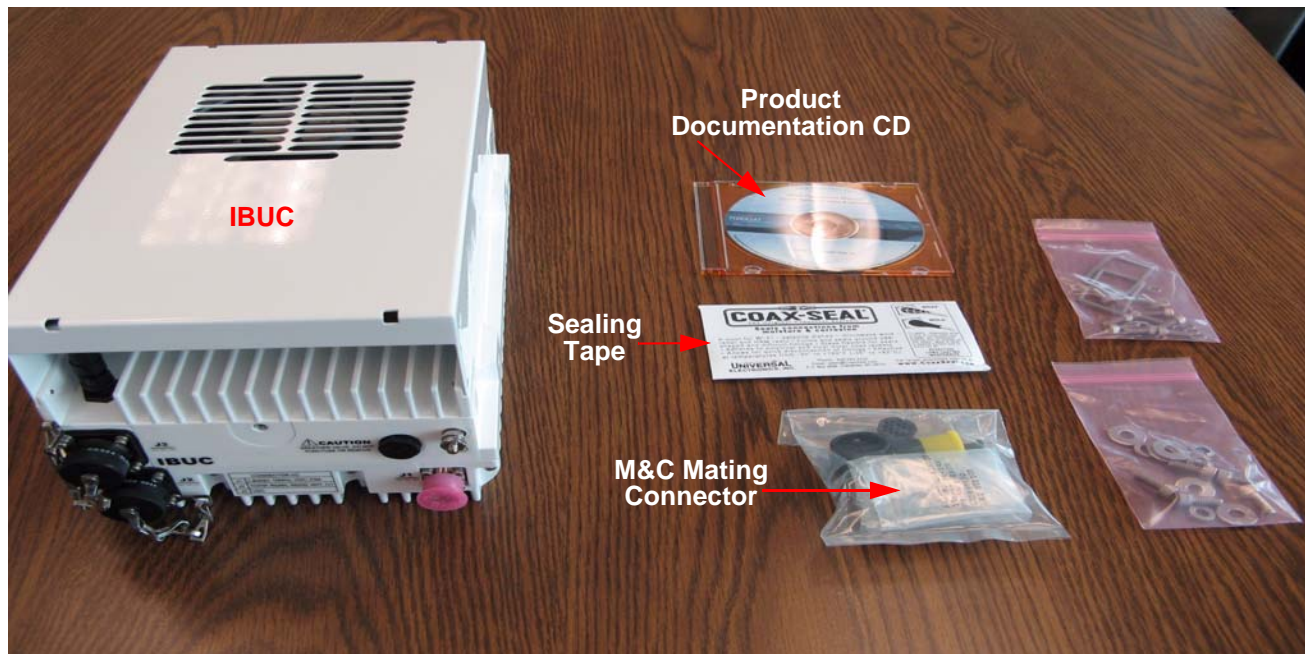

Figure 3.1 Contents of IBUC Shipping Carton

The following items are furnished with Tx (1+1) redundant systems:

- An integrated Tx 1+1 redundant system
- A waveguide switch, termination and waveguide pieces (C-band, X-band, Ku-band, DBS-band, or Ka-band)
- IBUC interface cables (L-band and M&C)
- Switch cable
- Interface module
- M&C mating connector
- Product documentation CD
- TCP/IP test cable

A TCP/IP test cable is furnished only with Tx 1+1 systems; for all other units, it is an optional accessory.

- Waveguide gaskets and hardware
- Fuses

The fuses are intended for 220 VAC operation and are supplied only with units that operate over the range of 100 VAC to 240 VAC.

- 5 g pouch of Permatex anti-seize lubricant

The anti-seize lubricant is a heavy duty high-temperature lubricant that prevents galling, seizing, and corrosion of fasteners during assembly and facilitates disassembly of parts exposed to heat or corrosive environments.

- Power supply mounting kit (optional)
- Mounting plate with brackets (optional)

Accessories

The following are optional accessories:

- A hand-held terminal and cable
- A waveguide Rx reject filter
- A four-way combiner/divider module
- TCP/IP test cable
- Waveguide pieces
- IFL cables (for example, LMR-400)
- Installation kits

Note: Exact contents of the shipping carton vary according to the model and type of IBUC.

Figure 3.2 illustrates what is packaged with an AC-powered Tx 1+1 system as it leaves the factory (includes the optional hand-held terminal).

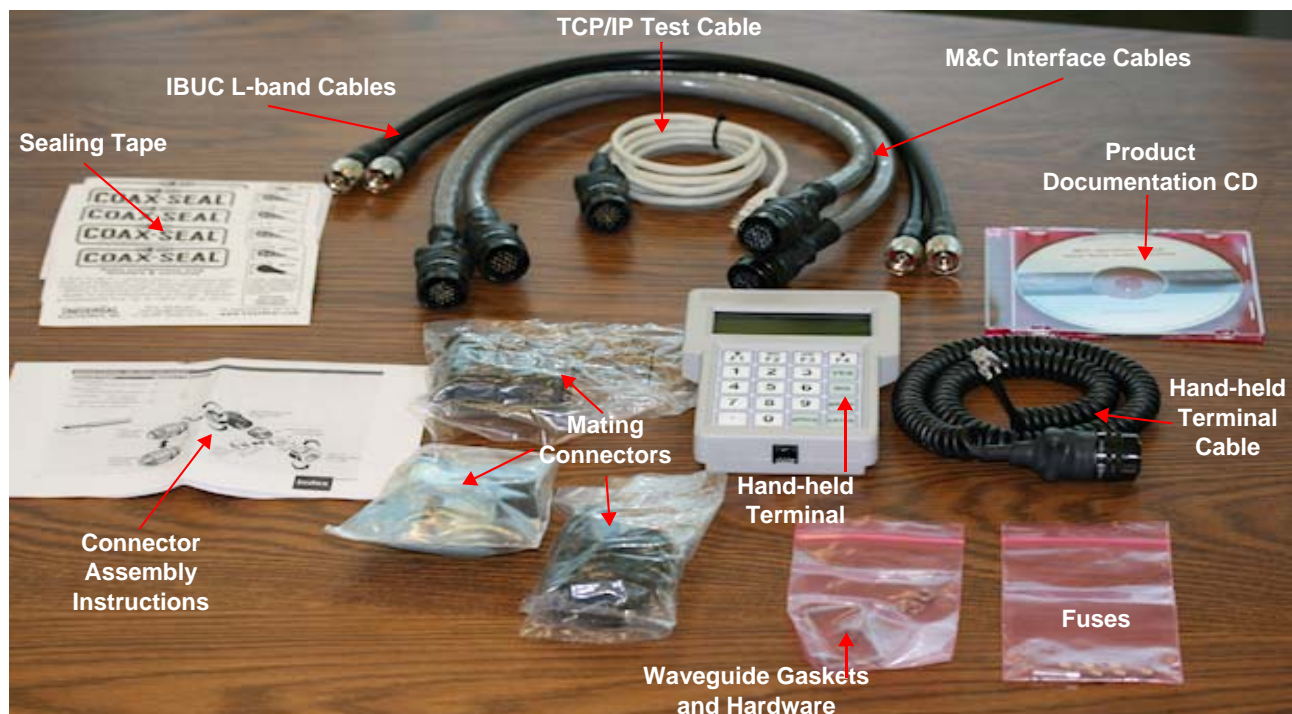

Figure 3.2 Contents of Tx 1+1 System Shipping Carton

Installing the ODU

Consider the following when preparing to install the ODU.

Tools and Test Equipment

Have on hand a standard electrician's tool kit and any tools listed in the antenna manufacturer's installation instructions.

Site Considerations

The ODU is designed to be mounted on or near the antenna. Locate and install the antenna according to instructions supplied by the antenna manufacturer. Choose an area that is free of interference from motors or other electrical equipment and that has a clear line of sight from the antenna to the satellite. Lightning arrestors should be used at the site to protect personnel and equipment. Use size 3/0 or 4/0 AWG (American Wire Gauge) stranded copper wire to ground the IBUC to the antenna frame and to the lightning protection ground rod. For higher power units with an external power supply, Terrasat recommends using an isolation filter to reduce power line interference.

Mounting Considerations

Optional mounting brackets are available to facilitate mounting on most antennas.

The ODU must be mounted such that:

- The IBUC has sufficient support to minimize the effects of antenna sway in strong winds.
- The fan intake and exhausts are free from any obstruction.
- The fan shroud is mounted so that the cut-outs are facing the ground.
- The heat fins have air movement across them.

Throughout installation and during any polarization, azimuth or elevation adjustment, ensure that cables and waveguide are not crimped or pinched.

Power Requirements

| | |
|---|---|
|  | <p style="text-align: center;">WARNING</p> <p>Installation and connection to the line power supply must be made in compliance with applicable wiring codes and regulations.</p> |
|---|---|

For IBUCs with a rated power level of 25 watts and below for C-band, 20 watts and below for X-band, 16 watts and below for Ku-band, and 8 watts and below for DBS-band; the power for the IBUC can come either from the IFL supplied from the Terrasat indoor IFU equipped with a 200 watt power supply or from a satellite modem equipped with a suitable IBUC power supply. DC power for these lower-power IBUCs can also be supplied directly through the external power connector (J3) by using the Terrasat 250 watt outdoor power supply. Refer to the part number label on the unit (shown in [Figure A.1](#) on [page A-1](#)) to determine voltage requirements. Ensure that the 24 VDC input voltage is from 20 VDC through 28 VDC and that the 48 VDC input is from 37 VDC through 60 VDC.

Outdoor Power Supply

IBUCs with a rated power level higher than 25 watt C-band, 20 watt X-band, 16 watt Ku-band, or 12 watt DBS-band; require a separate power supply. Terrasat offers a 600 watt outdoor power supply unit (PSUI) good for all power levels up to 80 watt C-band, 80 watt X-band, 50 watt Ku-band, 25 watt DBS-band, or 25 watt Ka-band; a 1000 watt outdoor PSUI good for all power levels up to 125 watt C-band, 125 watt X-band, or 80 watt Ku-band; and a 1200 watt outdoor PSUI good for all power levels up to 200 watt C-band, or 175 watt X-band. Units that get their power from the earth (or telecom) station do not require an external power supply. Power supplies have an autoranging AC front end that works with both 115 VAC and 230 VAC. However, the 1200 watt PSUI works only with 230 VAC.

Note: The 48 VDC IBUC can be configured at the factory as positive, negative, or floating. Ensure that the correct polarity is applied to any unit.

All IBUCs that are AC powered and all Terrasat outdoor PSUIs are furnished with a detachable AC power connector that is used to connect and disconnect power. When connecting the AC connector to the AC power source, the wiring must include a 15 amp or 20 amp circuit breaker. A disconnect device (such as a circuit breaker or mains supply plug on the power supply cord) that is readily accessible must also be provided. Any outdoor AC connections should be made using suitable connectors or boxes with an IEC protection class of at least IP65.

| | |
|---|--|
|  | <p style="text-align: center;">WARNING</p> <p>Ensure AC power is off when connecting or disconnecting the power supply unit's power cord. To turn off AC power to the unit, use the installed circuit breaker or a similar disconnecting device.</p> |
|---|--|

If a circuit breaker is not easily accessible as a disconnecting device, the input connector will be the disconnecting device. In this case, the socket-outlet must be installed near the equipment and must be easily accessible for pluggable equipment.

All AC-powered IBUCs and the Terrasat outdoor PSUI are furnished with mating connectors for the AC mains power cable. To remain compliant with European Low Voltage Directive (EN 60950-1), use a power cable that meets IEC 60227 requirements such as HAR Cable Designation H03VV-F or H03VVH2 -F and/or others with water resistance for outdoor applications. Power cable plugs must also comply with all applicable local and federal standards and regulations.

Indoor Power Supply

Terrasat offers 600 watt and 1000 watt indoor power supply units which provide 48 VDC power. The 600 watt PSUI can power C-band and X-band units through 60 watts, Ku-band units through 40 watts, DBS-band units through 25 watts, and Ka-band units through 25 watts. The 1000 watt PSUI can power units up through 150 watt C-band, 150 watt X-band, and 80 watt Ku-band IBUCs. Each indoor PSUI is packaged in a rack-mountable chassis which occupies one rack unit (1.75 in.) of space. The indoor PSUI is shipped with a mating connector for DC power and a power cord for AC mains.

Note: AC transients and surges can cause data transmission errors and loss of synchronization in the modem and/or the ODU. Take proper precautions to ensure uninterrupted service.

Grounding

Terrasat recommends the following grounding and lightning protection:

- **Cable Shielding**
Shield currents can be eliminated with proper techniques. A grounding strap at the end of the coaxial and data cables should be connected to the ground lug at the antenna base with a #4 gauge copper wire. This provides a path of least resistance prior to entering the electronic equipment.
- **AC**
The best way to protect the equipment is to have two protectors. The first is the power mains protector that is mounted directly across the mains in the breaker box. The second should be mounted or grounded directly at the base or hub of the antenna or at the 19-in. rack.
- **Data and Control Lines**
The I/O lines can deliver surge current to the equipment and should also be protected.

- **Electrical Grounding**

Grounding of the IBUC and PSUI units is recommended to prevent possible damage from lightning and/or other induced electrical surges. Terrasat recommends the use of 3/0 or 4/0 AWG stranded copper wire for bonding the IBUC and the PSUI to the earth ground (grounding rod), using the most direct or shortest route.

Antenna Recommendations

Most antenna masts are encapsulated in concrete. Typically, the mast pipe is submerged in a 4 ft – 5 ft (1.22 m – 1.53 m) deep augured hole. This provides a good Ufer ground. A Ufer ground, in this case, is defined such that concrete absorbs moisture quickly and loses that moisture slowly (as much as 15 to 30 days after rain or snow melt). The mineral properties of concrete and their inherent pH means concrete has a supply of ions to conduct current. The soil around concrete becomes “doped” by the concrete and, as a result, the pH of the soil rises. The moisture present in the concrete, in combination with the “doped” soil, makes a good connector of electrical energy. The concrete’s large volume and great area of contact with the surrounding soil allows a good transfer to the ground.

In the concrete base, a Ufer ground can be established by running a #4 gauge solid wire or rebar and connecting to the base of the pedestal with pigtails.

The Ufer ground is only one step in proper grounding. The Ufer ground should be augmented with coupled pairs of 10 ft (3.05 m) ground rods, placed 20 ft (6.1 m) into the ground, spaced 20 ft (6.1 m) apart. The first rod should be placed close to the antenna. The second rod should be placed towards the equipment enclosure. A #2 gauge wire should connect the rods and antenna mount. A ground rod should be placed at the equipment enclosure as well. If it is virtually impossible to install the ground rods, then radials are needed. This can be accomplished by laying 10 or more lengths of 1½-in. (3.81 cm) copper strap, at least 50 ft (15.24 m) long, in a radial fashion around the antenna base. The straps should be buried, if possible. The hub must be interconnected to the utility ground.

The ground configuration can vary from one location to another. It is best to measure the soil conductivity and design a 5 Ω ground system. To protect the system from a direct strike, a lightning rod placed 2 ft (61 cm) higher than the highest point of the dish should be interconnected to the Ufer ground with #2 gauge copper wire.

Antenna Mounting

The IBUC can be mounted on the focal point, the boom arm, the antenna back structure, or in the hub depending on the antenna type. Typical antenna installation configurations are shown in [Figure 3.3](#) through [Figure 3.6](#). The IBUC has mounting holes on both sides of the unit that can be used to attach the IBUC to the antenna. See [Figure 3.7](#) on [page 3-14](#) for the location of these mounting holes.

Figure G.3 on page G-4 contains a sample installation drawing for mounting an IBUC on the focal point of an antenna.



Figure 3.3 Mounting on Focal Point



Figure 3.4 Mounting on Boom Arm



Figure 3.5 Mounting on Antenna Back Structure



Figure 3.6 Mounting in Hub

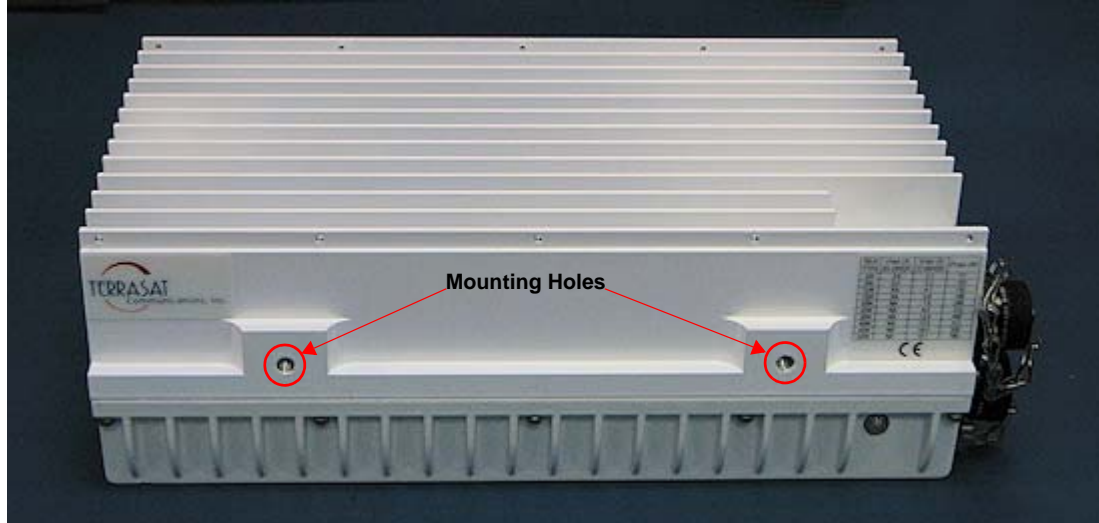

Figure 3.7 Location of Mounting Holes

There is also a mounting hole located on the front of the IBUC that is shown in [Figure 3.9](#) on [page 3-16](#). This mounting hole is on the same axis as the center of the waveguide of the unit (that is, it is in line with the center of the waveguide). This enables the unit to be rotated when mounted on the focal point of an antenna.

Optional mounting brackets are available which facilitate attachment to antennas. The mounting slots identified in [Figure 3.8](#) give you flexibility when attaching the IBUC to the antenna.

Note: Ensure that the threads of the bolts used for mounting the IBUC have been dipped in the included Permatex anti-seize lubricant. This prevents galling, seizing, and corrosion of fasteners during assembly and will facilitate future disassembly.

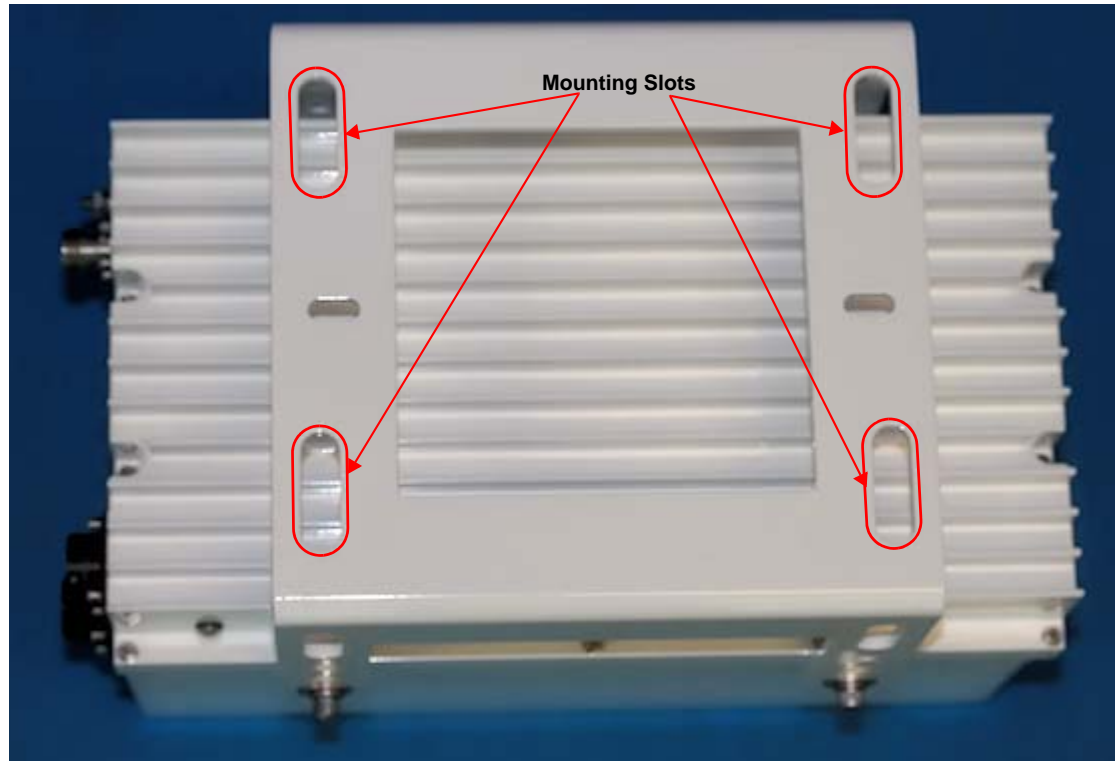

Figure 3.8 Location of Mounting Slots on Optional Mounting Bracket

System Pressurization

The IBUC chassis contains a breather valve (identified in [Figure 3.9](#)) that is designed to equalize pressure inside and outside of the unit while allowing the passage of air or water vapor but not environmental contaminants such as liquids, debris, or dust. If you intend to pressurize the waveguide, you must install a pressure window at the output of the IBUC, otherwise the breather valve will not permit pressurization of the system.

System Cabling Requirements

Cables and Connectors

Figure 3.9 shows the front panel of a lower power IBUC (such as a C-band up to 80 watts, an X-band up to 80 watts, a Ku-band up to 50 watts, a DBS-band up to 25 watts, or a 5 watt Ka-band) and identifies the locations of the J1, J2, and J3 connectors.

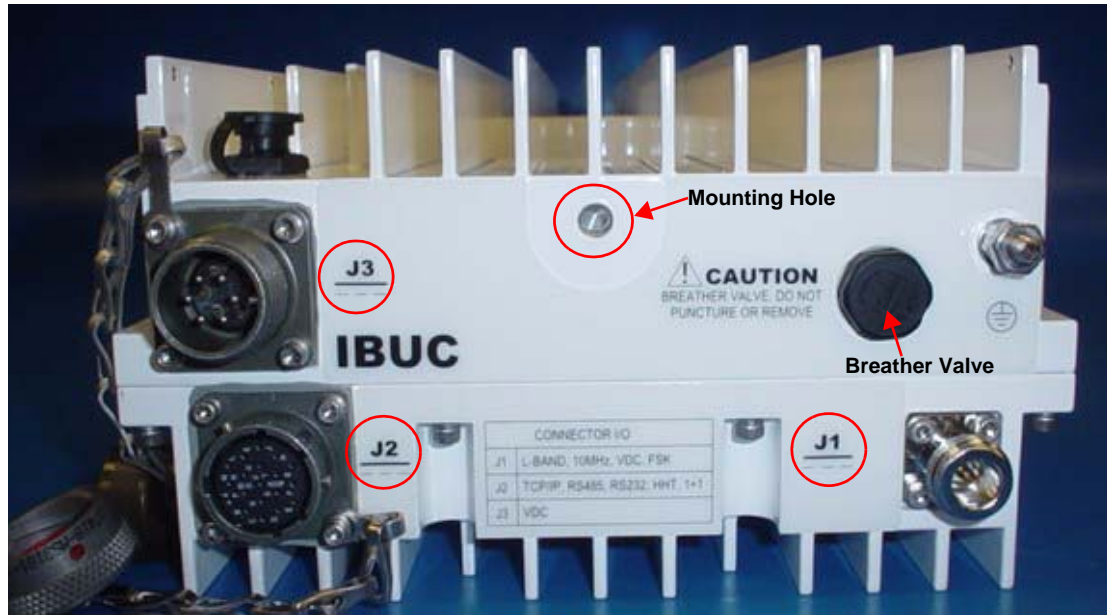

Figure 3.9 Front Panel of Lower Power IBUC

Figure 3.10 shows the back panel of a lower power IBUC and identifies the location of the RF Out waveguide interface.



Figure 3.10 Back Panel of Lower Power IBUC

Figure 3.11 shows the front panel of a higher power IBUC (such as a 100 watt C-band or higher, a 100 watt X-band or higher, or a 60 watt Ku-band or higher) and identifies the locations of the J1, J2, and J3 connectors.

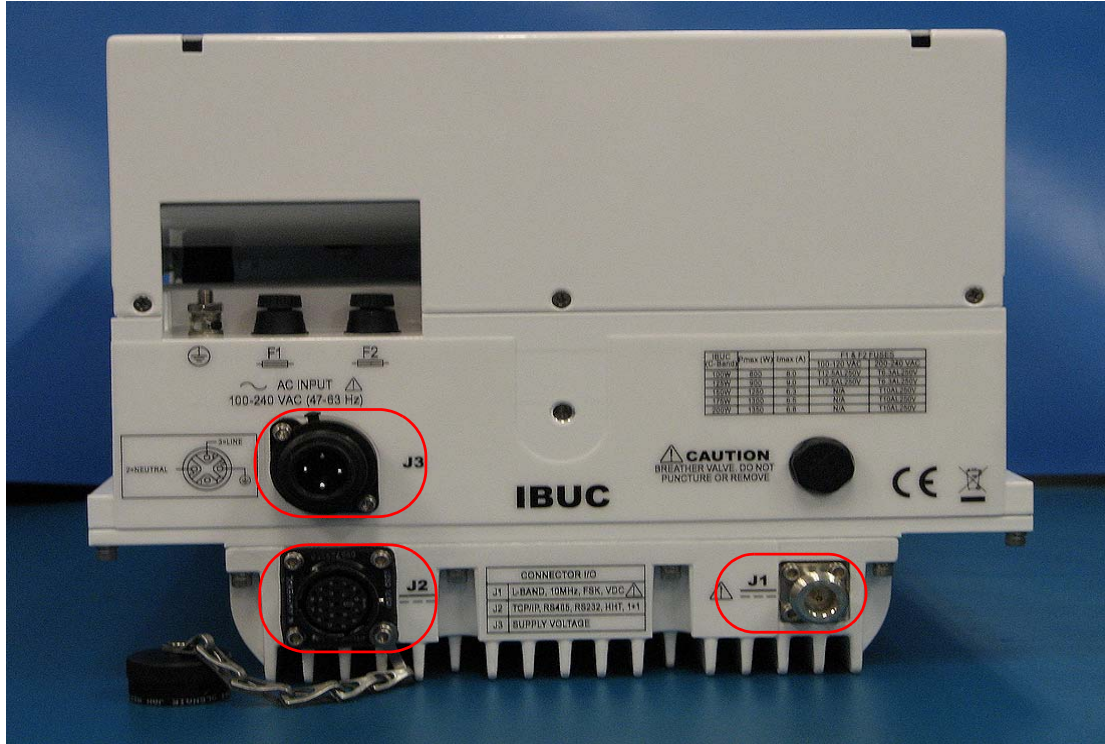

Figure 3.11 Front Panel of Higher Power IBUC

Figure 3.12 shows the back panel of a higher power IBUC and identifies the location of the J4 connector and the RF Out waveguide interface.

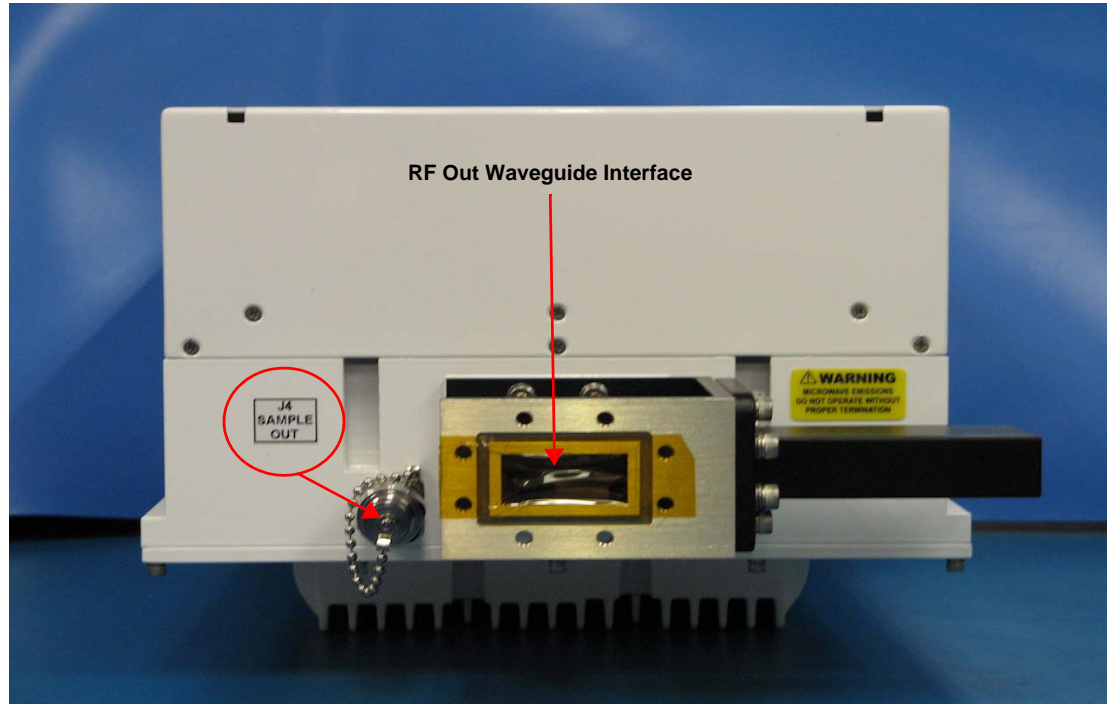

Figure 3.12 Back Panel of Higher Power IBUC

IBUC interface connectors and their mates are listed in [Table 3.1](#). Additional mating connectors and/or cables can be ordered from Terrasat as optional items.

Table 3.1 IBUC Interface Connector Schedule

| REFERENCE DESIGNATOR | FUNCTION | INTERFACE CONNECTOR | INTERFACE CONNECTOR MATE |
|----------------------|---------------|---|---|
| J1 | Tx Input | TYPE-N SOCKET (TYPE-F SOCKET optional) | TYPE-N PLUG (TYPE-F PLUG optional) |
| J2 | M&C Interface | AMPHENOL CIRCULAR, BOX MOUNTING SOCKET, 19S (PT02E-14-19S (027)) | AMPHENOL CIRCULAR, STRAIGHT PLUG, 19P (PT06E-14-19P (476)) |
| J3 | DC Power | AMPHENOL CIRCULAR, BOX MOUNTING SOCKET (ACS02E14S-6P (553)) | AMPHENOL CIRCULAR, STRAIGHT PLUG (ACS06E14S-6S (553)) |
| J3 ¹ | AC Power | CONNECTOR, MALE SOCKET, 3+PE (AMPHENOL C016 20C003 100 12) | CONNECTOR, PLUG CABLE, 3+PE (AMPHENOL C016 20D003 110 12) |
| J4 ² | Sample Port | TYPE-N SOCKET | TYPE-N PLUG |
| RF OUT | C-band | CPR137, CPRG WAVEGUIDE or TYPE-N SOCKET | CPR137, CPRF WAVEGUIDE or TYPE-N PLUG |
| RF OUT | X-band | CPR112, CPRG WAVEGUIDE | CPR112, CPRF WAVEGUIDE |
| RF OUT | Ku-band | WR75 COVER FLANGE WITH GROOVE | WR75 COVER FLANGE |
| RF OUT | DBS-band | WR62 COVER FLANGE WITH GROOVE | WR62 COVER FLANGE |
| RF OUT | Ka-band | WR28 COVER FLANGE WITH GROOVE | WR28 COVER FLANGE |

- 1 This is used only with units that are AC powered.
- 2 This is used only with high-power IBUCs (for example, 100 watt to 200 watt C-band, 100 watt to 175 watt X-band, and 60 watt to 80 watt Ku-band).

A mating M&C connector for J2 and a DC interface connector for J3 are available from Terrasat. For IBUCs with a rated power level of 25 watts and below for C-band, 20 watts and below for X-band, 16 watts and below for Ku-band, 8 watts and below for DBS-band, or 10 watts and below for Ka-band, the power for the IBUC may come through the L-band IFL supplied from the Terrasat IFU or the satellite modem. Power for the IBUC can also be supplied directly through the external power connector (J3). Options are available for 24 VDC, +48 VDC, -48 VDC, and floating. Refer to the part number label on the unit to determine which voltage is required. See [Appendix A](#) for more details about the data contained within the unit's serial and part numbers.

J1 – Transmit In The Tx In connector is a Type-N socket (Type-F socket, optional) connector used to connect the IF at L-band from the modem to the IBUC. Use 50 Ω cables (75 Ω for Type-F connectors) to connect to J1. Certain considerations must be taken when selecting the IFL because appropriate shielding and signal levels are required for normal system operation. The IBUC is designed to operate at rated power with a -30 dBm Tx L-band input signal, with the variable attenuator set to minimum attenuation. The variable attenuator is accessible through the M&C interfaces for system gain adjustment. In addition, the IBUC must have a 10 MHz input signal from +5 dBm through -12 dBm (only for IBUCs with an external 10 MHz signal). For IBUCs with both the optional internal 10 MHz reference signal and an external 10 MHz signal, the external signal will automatically receive priority without any user interaction.

For lower wattage units that are DC powered (such as the 25 watt C-band, 20 watt X-band, 16 watt Ku-band, 8 watt DBS-band, and 10 watt Ka-band and below), the coaxial cable should be selected for its current carrying capacity. A lower wattage IBUC can draw up to 6.0 amps. The maximum voltage drop for a 24 VDC IBUC is 4 volts and the maximum voltage drop for a 48 VDC IBUC is 11 volts. The cable should also have good shielding effectiveness in order to prevent outside interference.

 Note: The caution symbol (shown at left) that is printed on the chassis next to the J1 connector indicates that VDC may be present. See [Figure 3.11](#) on [page 3-18](#). In general, low-power units with positive or floating supply (such as those listed below) allow DC power via coaxial cable. However, AC-powered units cannot be supplied via coaxial cable.

| | |
|----------|------------------------|
| C-band | 5, 10, 20, or 25 watts |
| X-band | 5, 10, or 20 watts |
| Ku-band | 4, 8, 12, or 16 watts |
| DBS-band | 5 or 8 watts |
| Ka-band | 5 or 10 watts |

Note: Some modems provide an FSK communication link for M&C purposes via the same interface (J1).

Fire codes may require that cables in occupied buildings be installed in steel conduit. Local government agencies may waive this requirement with the use of Plenum cables, which are standard cables encased in solid Teflon. Check codes for your area.

Note: Equipment outage due to faulty installation is not covered by the Terrasat warranty. Terrasat recommends following OEM procedures when making cables and connectors.

J2 – M&C Interface The M&C Interface is a 19-pin, circular socket connector used to enable remote monitoring and control of IBUC operating parameters. Pin

assignments are shown in [Table 3.2](#). If the M&C port of the IBUC is going to be used, the cable should be a shielded multiconductor cable with at least two each 100 Ω twisted pairs (for TCP/IP). See the IP cable drawing in [Appendix G, Component Specifications and Reference Drawings](#) for more information about fabricating a cable. An optional pre-assembled IP test cable is available from Terrasat.

Table 3.2 Pin Assignments for IBUC M&C Connector J2

| Pin | Function |
|-----|-----------------------------------|
| A | RS485 (+) |
| B | RS485 (-) |
| C | Hand-held Terminal Power (+) |
| D | RS232 RXD |
| E | RS232 TXD |
| F | HHT, RS232, RS485 Common |
| G | TCP/IP Tx + |
| H | TCP/IP Tx - |
| J | TCP/IP Rx + |
| K | TCP/IP Rx - |
| L | IBUC Alarm Output Normally Open |
| M | IBUC Alarm Output Common |
| N | IBUC Alarm Input/Mute |
| P | IBUC Alarm Output Normally Closed |
| R | 1+1 Switch Command A |
| S | 1+1 Switch Command B |
| T | 1+1 Switch Indicator A |
| U | 1+1 Switch Indicator B |
| V | 1+1 Redundancy Enable |

Note: Pin F is the return to close the circuit for RS232.

J3 – DC Power DC power is supplied to the IBUC through a 6-pin circular socket connector.

Table 3.3 Pin Assignments for IBUC DC Power Connector J3

| Pin | Function |
|-----|----------|
| A | VDC - |
| B | VDC - |
| C | VDC - |
| D | VDC + |
| E | VDC + |
| F | VDC + |

Note: The IBUC is factory configured for positive supply (+48 VDC, standard), negative supply (-48 VDC, optional), or floating. J3 is internally connected, as follows:

- Positive Supply: VDC- is connected to Common
- Negative Supply: VDC+ is connected to Common
- Floating: No VDC connection to Common

Note: The operating voltage is integrated into the model number of each IBUC. See [Figure A.2](#) on [page A-2](#) for more information about the model number of your particular unit.

J3 – AC Power AC power is supplied to the IBUC through a 3-pin plus ground connector. The connector is configured as described in [Table 3.4](#).

Table 3.4 Pin Assignments for IBUC AC Power Connector J3

| Pin | Function |
|-----|----------|
| 1 | N/C |
| 2 | Neutral |
| 3 | Line |
| GND | Ground |

J4 – Sample Port The sample port is used to take a sample of the RF Out signal while the unit is transmitting for monitoring purposes. The sample is taken without interrupting or interfering with signal transmission. The coupling factor is approximately 40 dB.

Note: The coupling factor is not calibrated.

RF Out The output of a C-band IBUC is a WR137G waveguide or a Type-N connector, the output of an X-band is a CP112G waveguide, the output of a Ku-band IBUC is a WR75 cover with groove waveguide, the output of a DBS-band IBUC is a WR62 cover with groove waveguide, and the output of a Ka-band IBUC is a WR28 UG cover with groove waveguide.

Cable and Waveguide Connections

| | |
|---|---|
|  | WARNING |
| | Ensure that all power is disconnected prior to making any connections. |

When installing the cable and waveguide assemblies, ensure that all connections are weather tight. If an Rx reject filter is being used, attach it to the IBUC waveguide output. Use proper gasketing methods to prevent the entry of water.

Water-Resistant Wrap

Terrasat recommends applying water-resistant wrap (such as mastic tape) to all outdoor connectors to prevent water entry and subsequent water damage. Mastic tapes are designed to flow and self-heal if cut or punctured. When applied spirally with the proper tension, mastic tapes form a tight continuous coating that permits little or no moisture absorption or penetration. Terrasat provides water-resistant sealing tape for Type-F and Type-N connectors.

Apply the mastic tape, as follows:

1. Ensure that all connectors are firmly tightened, dry, and free from all grease, dust, and dirt.
2. Cut the mastic tape to the desired size. The tape should be long enough to cover the connector completely.
3. Center the tape on the connector to be sealed and wrap the tape in a tight spiral around the connector using a 50% overlap. Squeeze the tape tightly and ensure that both ends of the tape have formed around the connector and the cable without any gaps.

Apply the tape to all connectors that may be exposed to moisture.

Applying the Anti-Seize Lubricant

Terrasat recommends applying anti-seize lubricant to screws and bolts that could be exposed to weathering or corrosive environments. The lubricant prevents galling, seizing, and corrosion during assembly and facilitates future disassembly. A 5 g packet of Permatex Anti-Seize Lubricant is included with the installation kit for this purpose.

To apply the anti-seize lubricant,

1. Wear appropriate personal protection equipment to avoid contact with skin and eyes. This includes safety glasses, neoprene or nitrile gloves, and clothing sufficient to limit skin exposure.
2. Ensure that mating surfaces (screw holes) are clean; dry; and free of dirt, debris, or loose surface rust.
3. Use a brush or lint-free cloth to apply a thin coat of Anti-Seize to the screws and bolts that require protection, as shown in [Figure 3.13](#). The Anti-Seize should be applied right down to the base of the threads.



Figure 3.13 Applying the Anti-Seize Lubricant

4. Spread the lubricant to a thin film without any lumps.
5. Reassemble the parts using normal torque values.
6. Wipe off an excess material with a disposable towel.

Installing the Ferrite Cylinder on the Supply Cable

1. Fabricate a supply cable using the connectors provided.
2. Open the smaller ferrite cylinder (P/N 28A0807-0A2), and then place the cable into the channel that runs down the middle of the ferrite cylinder.
3. Using your fingers, measure the length of four fingers from the connector end.
4. Snap the ferrite cylinder closed.
5. Use the instructions in the previous section to seal the connector with the provided mastic tape.

Waveguide Connections

If necessary, connect a section of flexible waveguide between the orthogonal mode transducer (OMT) transmit port and the IBUC Tx RF output (or optional Rx reject filter). The waveguide should be attached to the antenna feed according to the manufacturer's instructions. Use proper gasketing methods to prevent water entry and subsequent damage.

Note: The C-band IBUC is also available with an optional N-type Tx output connector that requires an appropriate RF cable between the IBUC output and the OMT instead of a waveguide.

Typical Configuration Without an Interface Unit (IFU)

While there are many possible configurations, [Figure 2.9](#) on [page 2-19](#) illustrates a typical configuration for DC-powered low power IBUCs and [Figure 2.11](#) on [page 2-21](#) illustrates a typical configuration for DC-powered high power IBUCs.

To configure the IBUC without an IFU,

1. Connect the IFL coaxial cable between the Tx Output from the modem and the J1 connector (Tx In) on the IBUC.
2. Connect a coaxial cable between the LNB (Rx Output) and the modem's L-band Rx Input.
3. Connect the M&C cable between the J2 connector (M&C) on the IBUC and the appropriate M&C or LAN connection.
4. Connect the DC cable between the DC Output connector on the power supply and the J3 connector (DC Input) on the IBUC.
5. Connect the AC cable between the AC Input connector on the power supply and the AC power source.

Configuration With an Interface Unit (IFU)

See [Figure 2.10](#) on [page 2-20](#) for an illustration of this configuration for low-power IBUCs or [Figure 2.11](#) on [page 2-21](#) for an illustration of this configuration for high-power IBUCs.

To configure the IBUC with an IFU,

1. Connect the IFL coaxial cable between the J1 connector (Tx In) on the IBUC and the J2 connector (Tx out) on the IFU.
2. Connect a coaxial cable between the J1 connector (Tx In) on the IFU and the modem (Tx L-band out).
3. Connect the coaxial cable between the LNB (Rx Output) and the J4 connector (Rx In) on the IFU.

4. Connect a coaxial cable between the J5 connector (Rx Output) on the IFU and the modem's L-band Rx Input.
5. Connect the M&C cable between the J2 connector (M&C) on the IBUC and the appropriate M&C or LAN connection.
6. Connect the DC cable between the J2 connector (DC Output) on the outdoor PSUI, as appropriate, and the J3 connector (DC Input) of the IBUC. Low power units can be supplied from the modem or from the IFU through the coaxial cable to the IBUC.
7. Connect the AC cable between the PSUI J1 (AC Input) and the AC power source.

Configuration With an AC-powered IBUC

To configure an AC-powered IBUC without an IFU,

1. Connect the IFL coaxial cable between the Tx Output from the modem and the J1 connector (Tx Input) on the IBUC.
2. Connect a coaxial cable between the LNB (Rx Output) and the modem's L-band Rx Input.
3. Connect the M&C cable between the J2 connector (M&C) on the IBUC and the appropriate M&C or LAN connection.
4. Connect the AC cable between the AC Input J3 connector on the IBUC and the AC power source.

Basic System Alignment

The following sections outline the procedure for setup and alignment of an earth station. Prior to ODU alignment, the antenna should be set to the desired azimuth and elevation settings per manufacturer's instructions.

| | |
|---|--|
|  | <p style="text-align: center;">CAUTION</p> <p>The IBUC must not transmit until alignment and any necessary adjustments are complete.</p> |
|---|--|

Test Equipment

Terrasat recommends the equipment listed in [Table 3.5](#) (or its equivalent) for installation and system alignment.

Table 3.5 Recommended Test Equipment

| Equipment | Type |
|---|---|
| Spectrum Analyzer | Agilent HP8563E |
| Digital Voltmeter | Fluke 8050 |
| Adapter Waveguide to coaxial | C-band or Ku-band |
| RF cables | With calibrated insertion loss up to 15 GHz |
| 40 dB attenuator | High power to match HPA output |
| Assortment of cables, connectors and adapters (calibrated up to 15 GHz) | |

Ensure that the IBUC Tx output power is disabled to prevent accidental transmission interference with adjacent satellites or transponders before attempting to align or perform any other operation involving the ODU. Before attempting any system changes, carefully evaluate the possible effects of the transmitted signal.

Setting the Tx and Rx Frequencies

All transmit and receive frequencies are set in the modem.

If using a direct connection to an L-band modem, follow the manufacturer’s instructions for setting the transmit and receive frequencies.

Receive L-band Output Measurements

To check the receiver,

1. Ensure that 15 VDC to 24 VDC (LNB Bias) is present at the modem or IFU Rx input.
2. Use a spectrum analyzer to ensure that the 10 MHz signal is present at the modem or IFU Rx input.

| | |
|---|--|
|  | WARNING |
| | <p>DC power will be present on the cable. Terrasat recommends the use of a DC block when using a spectrum analyzer.</p> |

3. Connect the LNB to the demodulator’s Rx input by attaching the coaxial cables from the Rx L-band Out on the LNB to the demodulator’s Rx L-band input port.

When configured with the IFU, connect the IFU Rx Out (J5) to the demodulator's Rx L-band input port and connect the LNB to the IFU Rx input by attaching the coaxial cables from the Rx L-band Out on the LNB to the Rx input port (J4) on the IFU.

Transmit Power Alignment

Transmit L-band Input Adjustment with Modem or Converter

| | |
|---|---|
|  | <p>WARNING</p> <p>DC power might be present on the cable. Terrasat recommends the use of a DC block when using a spectrum analyzer.</p> |
|---|---|

To set the power level of the modulator output,

1. Use a spectrum analyzer to measure the power level of the L-band signal at the output of the coaxial cable that connects to the IBUC at the Tx L-band input (J1).
2. Use the modem or converter level adjust to increase and decrease the power level. Adjust to reach a level of -30 dBm. (All IBUC units are designed to reach rated power at p1 dB over frequency and temperature with -30 dBm at the input when the attenuator is set to minimum attenuation.) For some modems and shorter cable runs, it is not possible to reach -30 dBm. In this case, the attenuator in the IBUC may be used instead.
3. Check that the 10 MHz reference signal is present and within the range of +5 dBm through -12 dBm.

Note: The IBUC requires a 10 MHz reference signal to operate. Check the model number of the IBUC to determine whether an external 10 MHz signal is required.

4. Disconnect the spectrum analyzer from the coaxial cable.

Transmit RF Output Adjustment with Modem or Converter (70 MHz to L-band)

To adjust the power level of the IBUC transmitter output,

1. Connect a waveguide to coaxial adapter and a 40 dB high-power attenuator to the IBUC Tx waveguide output.
2. Ensure that DC power to the IBUC is applied in the proper voltage range. (Depending on your setup, this could be through the coaxial cable or through the J3 connector.)
3. Connect the Tx L-band input signal to the J1 connector (labeled Tx L-band) on the IBUC.

4. Enable the Tx signals in the modem or converter and the IBUC.
5. Measure the RF output with a power meter connected to the attenuator attached at the waveguide output. For accuracy, measure pure carrier (that is, continuous wave or CW) and the frequency allocated to you by the satellite network operations center.
6. If the modem still has available range, use the level adjust to reach the designated power level. If there is not, use the attenuation setting on the IBUC.

Note: To set attenuation on the IBUC, you first need to establish communication with the IBUC. See [Chapter 5, Monitor and Control Features and Functions](#) for more information about the various M&C interfaces you can use to establish communication.

7. If using a Satellite modem: Adjust the RF output to the designated power level (provided by the satellite network operations center, or its engineering staff) with the L-band output (modem) level adjust.
8. Disable the Tx signal in the modem or converter.
9. Disconnect the Tx L-band input signal.
10. Remove the waveguide to coaxial adapter and install the transmit waveguide section to the antenna transmit feed.
11. Once the transmit input and output power levels have been set, begin transmitting by connecting the Tx L-band input signal to J1 on the IBUC and enabling the Tx in the modem or converter.
12. Under the guidance of the network operations center (NOC), fine adjust the transmit power for the desired down link margin at the receiving station by adjusting the Tx L-band output level adjust (modem or converter output) or by adjusting the gain of the IBUC by setting the Tx attenuator.

Final Checks

To ensure reliable operation, inspect the system for crimped or pinched cabling. Make sure all connections are secure and sealed. Once the system has been aligned and is operating satisfactorily, the IBUC will require infrequent maintenance.

4

OPERATIONS

This chapter describes general operation of the IBUC.

After the IBUC has been mounted and connections verified, the antenna must be aimed toward the appropriate satellite. Follow the antenna manufacturer's instructions, using the coordinates (azimuth, elevation, and polarity) provided by the satellite operator. Do not transmit until you have received authorization—including a transmit power level—from the satellite network operations center (NOC) staff.

Start-up Checklist

The IBUC leaves the factory pre-configured for operation; however, you can fine-tune its settings for your particular needs.

Prior to start-up, verify the following:

- Transmit/Receive frequencies

All transmit and receive frequencies are set using the modem. Follow the manufacturer's instructions.

- Cable connections

Ensure that all of the external cables between the IBUC and other equipment are seated correctly and that there are no breaks or cracks; no sharp bends, pinch points, nor flattened sections in the cables.

- Power

Ensure that the IBUC is receiving power. Power can come via the modem, an external power supply, or from AC mains.

If power is supplied by the modem, ensure that the modem provides the correct DC voltage and that DC power has been enabled.

- 10 MHz reference signal

Verify that the 10 MHz reference signal is present. Some IBUCs have an internal 10 MHz reference signal. If this option is not available, a 10 MHz reference signal supplied on the IF cable from the modem (or an IFU) is required.

Turning On the IBUC

To turn on the IBUC,

1. Connect the L-band input cable (J1), the M&C cable (J2), and the power cable (J3)
2. Apply power to the IBUC.
3. The Power LED on the side of the unit next to the J2 connector lights up.

A flashing green light indicates that the IBUC is operating normally.

A red light indicates only that a fault (or alarm) has occurred. (A flashing red light indicates a minor alarm and a solid red light indicates a major alarm.)

4. Allow the unit to warm up for approximately 15 minutes before operating the transmitter module. This will assure stable gain and power.

Setting Operating Parameters

To set operating parameters, the IBUC must be connected to a terminal (for example, a hand-held terminal, a terminal emulator such as HyperTerminal, or the embedded Web pages via a PC). The most user-friendly way to connect to the IBUC is by using the embedded Web pages. Connect the IBUC to the Ethernet port of a PC by using a TCP/IP cable assembly (such as the one shown in [Figure G.2](#) on [page G-3](#)).

1. Establish communication with the IBUC by using the steps provided in [Appendix F, IBUC Web Pages](#).
2. Navigate to the Transmit Configuration tab as shown on [page F-13](#).
3. Set the Tx Output by selecting whether the unit is actively transmitting or not. Options include:
 - Enable
 - Disable

When the Tx Output is set to Disabled, the Tx Output level displayed on the Sensor Tab (shown on [page F-11](#)) reads -99.0 dBm. This is not the actual reading.

When conditions cause the automatic shut-off of the Tx Output signal, the Tx Output is muted and the Tx Output level displayed on the Sensor Tab (shown on [page F-11](#)) reads -96.0 dBm. This is not the actual reading.

Note: This setting can be overridden by the modem. The modem will send commands (data) to the IBUC and no single port is given priority. This continues as long as

both the IBUC and the modem use Legacy Binary mode. If the IBUC is set to ASCII mode, communication between the modem and the IBUC ceases due to the differences in command formats.

4. Set the Power Monitor Frequency that is used to set at which frequency you are operating. The factory default values in [Table F.1](#) on [page F-14](#) are listed according to the model number of the IBUC.

Note: To ensure accurate readings, you must set the actual operating frequency.

Example: If, according to your Satellite NOC, your allocated frequency is 6400 MHz, set the Power Monitor Frequency to 6400 MHz. Do not use the factory default value unless that is your actual operating frequency.

5. Set the Power Read Mode.

Options include:

- Burst
- Continuous Wave

6. Set the Gain Mode.

Options include:

- Open

Open is the gain obtained when there is no feedback in the measuring loop.

- AGC (Automatic Gain Control)

The IBUC continuously monitors input and output levels. When AGC is enabled, the gain of the system is maintained at a constant level by an internal algorithm. Gain is the difference between output power and input power.

- ALC (Automatic Level Control)

Similar to the AGC system, when ALC is enabled the gain is adjusted when changes are detected in order to maintain a constant output level.

Note: The IBUC has an internal temperature compensation feature that minimizes gain variations due to changes in temperature. This feature is configured at the factory and requires no user input. For specific information about your particular model IBUC, see the datasheets in [Appendix G, Component Specifications and Reference Drawings](#).

Setting the Tx frequency (L-band)

Changing the L-band frequency will cause a change to the RF frequency.

To set the L-band frequency,

1. Establish communication with the IBUC by using the steps provided in [Appendix F, IBUC Web Pages](#).
2. Navigate to the Information tab as shown on [page F-6](#).
3. Verify the data in the Band Inversion field.
4. Calculate the IF frequency by using the following formulas:

$$\text{IF} = \text{RF} - \text{LO} \quad \text{Non-inverted/Low side}$$

$$\text{IF} = \text{LO} - \text{RF} \quad \text{Inverted/High side}$$

Note: RF and LO frequencies for various bands are provided in [Table 2.1 on page 2-2](#).

Setting Alarm Thresholds

Although the IBUC will function using the factory-configured settings, by setting high and low level thresholds for the Tx Input/Output you can access more information about events such as power fluctuations that might trigger an alarm.

Alarms will be generated when the input and output amplitudes fall outside of the threshold ranges. For this reason, Terrasat recommends that when you have reached the proper input and output settings for your budget, you narrow the threshold ranges for alarms.

1. Set the Tx Input High/Low Thresholds.

The IBUC leaves the factory with a default range of -15 dBm to -60 dBm.

Example: After observing the unit, you determine that the IBUC operates consistently at -37 dBm. Although the threshold range is 45 dB, that range is too wide for everyday use. Instead consider setting the input thresholds at ± 3 dB; this would make the high level threshold -34 dBm and the low level threshold -40 dBm.

Note: You will receive an error message if the input level exceeds the threshold range.

2. Set the Tx Output High/Low Thresholds.

When you set up your system and the Tx Output reaches its budgeted level, Terrasat recommends that, instead of the (P1dB - 20 dB) to (P1dB + 1 dB) threshold range that is the default, you narrow the range between the high and low thresholds to ± 3 dB.

Example: After observing the unit, you determine that the output level operates consistently at 32 dBm. Although the threshold range is 21 dB, that range is too wide for everyday use. Instead consider setting the output thresholds at ± 3 dB; this would make the high level threshold 35 dBm and the low level threshold 29 dBm.

- Note: You will receive an error message if the output level exceeds the threshold range.
3. Verify your settings against the readings on the Info Page as shown on [page F-6 of Appendix F, IBUC Web Pages](#).

Configuring Alarm States

The IBUC offers flexibility with the levels of alarms produced when user-specified thresholds are exceeded.

1. Consider which alarms to configure. [Table 5.1 on page 5-4](#) contains the default alarm configuration.
2. Navigate to the Alarm Configuration tab shown on [page F-24 of Appendix F, IBUC Web Pages](#).
3. Use the drop-down menus to mark an alarm as a major event, a minor event, or to disable it.
4. Click Save Settings when you have completed your inputs to ensure that your settings are saved. If you do not click Save Settings, your changes will not be implemented.

Configuring ALC/AGC

The IBUC offers two methods of ensuring consistent signal levels: automatic level control (ALC) and automatic gain control (AGC).

ALC

When enabled, the Automatic Level Control (ALC) circuitry in the IBUC monitors output levels and adjusts the gain to maintain a consistent output for input signal variations as great as ± 8 dB. If a signal level is consistently below the predetermined target level, the ALC will cause the gain to be increased until the target level is reached. If a signal level exceeds the target level, the ALC will decrease the gain.

To enable ALC,

1. With the Gain Mode set to “Open” and the Tx Input and Tx Output Thresholds set, monitor the Tx Output level in order to determine a baseline setting.
2. When the Tx Output Level reading equals what you want to maintain, enable ALC by using any of the M&C interfaces.

The IBUC will now continuously self-monitor, increasing or decreasing the gain in order to maintain a constant signal at the level you defined.

- Note: The Tx Output Level is “captured” when ALC is enabled.

AGC

When enabled, the Automatic Gain Control (AGC) circuitry in the IBUC maintains the gain constant and equal to the target gain that was established when AGC was enabled.

Gain control settings can drift with time or temperature changes. You can reset the Gain Control function (when reset, the Gain Control returns to mid-range or 0.0).

Terrasat units enable you to offset the target by using the attenuation control without having to first disable the ALC or AGC.

Example: Set the output power level to 40 dBm and enable ALC. From this point forward, the ALC algorithm will maintain the output level at 40 dBm.

If you want to change the output level to 41 dBm, reduce the attenuation by 1 dB. The target level will be updated automatically.

Configuring the External Mute

Pin N of the M&C interface connector has dual functionality: it functions as an alarm input or an external mute.

External Mute

When the IBUC operates as a single thread IBUC, Pin N of the M&C interface connector functions as an external mute. If it is not connected (left open), then transmission is not muted. When Pin N is connected to Pin F (chassis ground), transmission is muted.

To re-enable transmission, remove the Pin N connection to Pin F. Transmission will now resume.

Alarm Input

When the unit is operating as part of a redundant IBUC system, the redundant configuration is sensed automatically. In redundant systems, Pin N functions as an alarm input where the alarm output of the A: side IBUC is connected to the alarm input of the B: side IBUC and vice versa.

For more information about the M&C interface connector, see [System Cabling Requirements](#) on [page 3-16](#).

Common Errors

LED is Red

A red LED indicates only that a fault (or alarm) has occurred and does not necessarily indicate that transmission has stopped. A flashing red light indicates a minor alarm and a solid red light indicates a major alarm. You can communicate with the IBUC to determine what is causing the fault, and then clear the fault condition.

1. Establish a connection with the IBUC by using any of the M&C interfaces described in [Chapter 5](#).
2. View the Alarm Status Tab (shown on [page F-8](#)) to determine the current alarm. You can also check the Sensor Tab (shown on [page F-11](#)) to determine which reading caused the alarm, and then compare the readings with the threshold levels. If necessary, adjust the threshold level(s).

When the fault is cleared, the LED should be flashing green.

No Power to the IBUC

If the Power LED is off or not turning on at all, the IBUC is probably not receiving power.

Restore power to the IBUC by

- If the IBUC is powered by the modem, verifying that the modem is working properly.
- Checking that the modem is receiving power (that is, the modem power cord is plugged in) and that DC power to the IBUC is enabled.
- Checking that all cable connections are solid.
- Checking that the power supply is functioning or that AC mains has the proper voltage.
- Checking the disconnect devices such as the circuit breaker.
- Checking the fuses.
 - For DC-powered IBUCs, the fuses are in the power supply.
 - For AC-powered IBUCs, the fuses are in the IBUC.

Fuses are 5x20 mm time-lag glass body cartridge type.

| | |
|---|---|
|  | WARNING |
| | Before applying power to the unit, ensure that that waveguide output is properly terminated. Failure to do so could lead to serious personal injury, excessive RF radiation levels, and equipment damage . |

Time Stamp Data is Incorrect

The time stamp on the alarm log is incorrect after the IBUC has lost power for an extended period. You can set the system date and time by using the hand-held terminal (see [Appendix E](#)) or the System Configuration tab of the embedded Web pages (see [Appendix F](#)).

Note: If you have an older IBUC whose firmware version has been upgraded to give you the time stamp function, the system clock will reset each time the IBUC loses power. Without the capacitor that was added beginning with hardware version 19, there is no backup for the system clock.

System Time Stamp is Different

When using a Web browser to access the embedded Web pages, the time stamp information displayed differs slightly by Web browser. The time stamp displayed on the Web pages records the time that the page was created and is based upon the system time of the computer, and not the IBUC.

Satellite Network Operations Center Doesn't Recognize Signal

The IBUC appears to be transmitting a signal, but the satellite network operations center (NOC) cannot identify your carrier.

To determine whether your settings are correct,

1. Verify that your frequency is within the bandwidth slot that was allocated to you.
2. Determine whether the IBUC operates with the LO on the low side or the high side of the frequency that was allocated to you.
3. Check the signal mix. Remember that low-side is non-inverting and high-side is inverting.
4. Use the following formulas to calculate IF frequency

low side $IF = RF - LO$ Non-inverting

high side $IF = LO - RF$ Inverting

The LO for each IBUC band is found in [Table 2.1 on page 2-2](#).

5. Check the Tx output level.

When Tx output power is disabled, the Tx output level will read -99.0 dBm. This is not an actual power reading; rather it indicates the loss of power.

When conditions cause the automatic shut-off of the Tx output signal, the Tx output level will read -96.0 dBm. This is not an actual power reading; rather it indicates the automatic shut-off of power.

Transmit Power in Saturation

The IBUC, at minimum attenuation, makes rated power at -30 dBm input. Operating the IBUC at higher levels will result in spectral distortion and high intermodulation levels. Terrasat recommends operating with power back-off levels sufficient to meet the spectral density mask.

To avoid signal saturation,

1. Reduce input power from the modem.
2. Increase the attenuation setting of the IBUC.

Tx Input/Output Level Verification

To verify the Tx IF Input level,

1. Use the Sensor Tab of the embedded Web pages to check levels.
For more information about the Sensor Tab, see [page F-11](#).
2. Compare the reading to your expected level.
The detector range is -55 dBm to -20 dBm.

To verify the Tx RF Output level,

1. Use the Sensor Tab of the embedded Web pages to check levels.
For more information about the Sensor Tab, see [page F-11](#).
2. If your reading does not match your expected level, first verify that the IBUC is receiving the proper input level.
3. If the input is at the correct level, use the Transmit Configuration Tab of the embedded Web pages to modify the attenuation to set the output to the expected level. The Transmit Configuration Tab is shown on [page F-13](#).

4. If, after setting the output to your expected level, you are still having transmission problems, check the flexible waveguide and antenna feed for obstructions. Also check the alignment of the antenna.

MONITOR AND CONTROL FEATURES AND FUNCTIONS

You must first establish communication with the IBUC to be able to take advantage of the various monitor and control (M&C) features of the IBUC.

M & C Interfaces

This chapter describes the various M&C interfaces the IBUC offers.

RS232

No additional configuration of the IBUC is required for proper RS232 operation. The RS232 port uses ASCII protocol and a fixed baud rate of 9600, 8 stop bits, no parity, no flow control, and one stop bit for communication.

To initiate an RS232 session,

1. Connect a 19-pin to DB9F cable between the computer and the IBUC.
[Figure G.1](#) on [page G-2](#) contains a drawing for fabricating a cable.
2. Activate a terminal emulation program such as HyperTerminal.
See [Appendix B, Using HyperTerminal](#) for information about how to connect using HyperTerminal.
3. Type four grave accent marks (e.g., ````), and then press Enter.
Although the default mode for the IBUC is RS232, typing the four grave accent marks upon activating a terminal emulation program ensures that the unit is in RS232 mode.
4. Type the password command `CPE=1234` and then press Enter.
You can now use the ASCII commands described in [Appendix C, ASCII Command/Response Structure](#) to configure and monitor the IBUC.

Note: The password entered in [Step 4](#) is the factory default password of 1234. If you have changed the password, type that value instead.

The RS232 port is shared with the hand-held terminal.

Hand-held Terminal

The hand-held terminal (HHT) shown in [Figure 5.1](#) is an optional item that can be used to access the IBUC via port J2 for local monitor and control. No additional configuration of the IBUC is necessary.

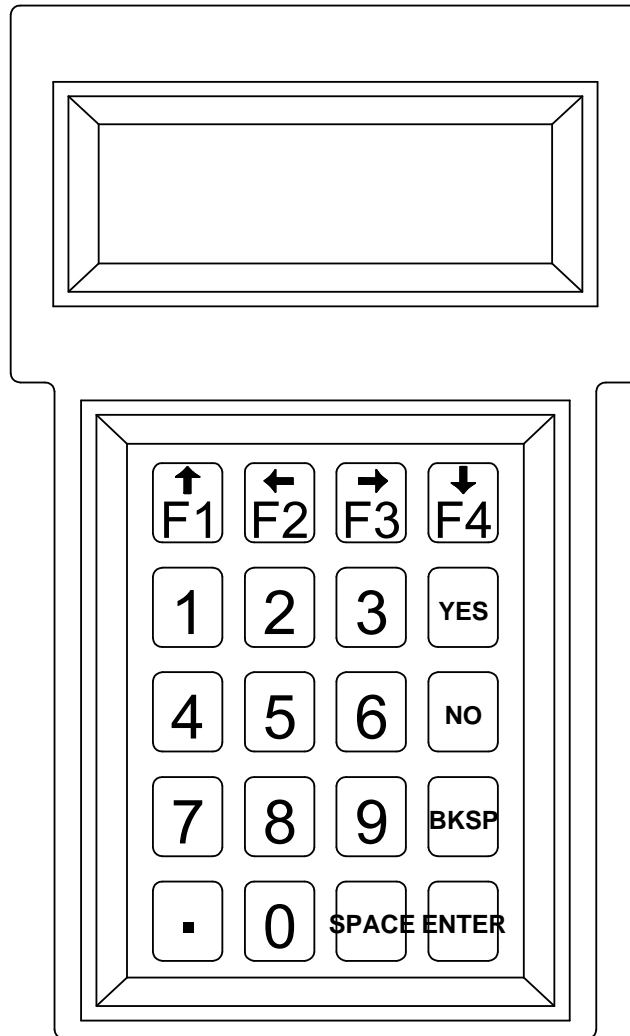

Figure 5.1 IBUC Hand-held Terminal

To activate the HHT,

1. Connect the supplied cable to the J2 connector on the IBUC and plug the RJ-11 connector into the HHT.

2. When a flashing cursor is seen in the upper left of the HHT screen, press the decimal key four times (that is, “. . . .”).
The login screen shown in [Figure E.1](#) on [page E-2](#) will appear.
3. Type the password.
The default password is 1234. If you have changed the password, type that value instead.

The HHT is now ready to accept commands.

Additional information about the HHT is in [Appendix E, IBUC Hand-held Terminal Menu Tree](#).

Multifunction LEDs

The multifunction LEDs are mounted on the IBUC housing and provide visual indications of IBUC status. LED colors and modes are as follows:

- Flashing Green - No alarms
- Flashing Red - Minor alarm being reported
- Steady Red - Major alarm being reported

Certain alarms are configurable meaning that you define them as major or minor alarms when thresholds you set are exceeded. Major alarms will cause relay closure (Form-C). The alarms shown in [Table 5.1](#) are the factory default configuration. Thresholds for alarms that are user configurable can be set by using any of the M&C interfaces described in this chapter.

Table 5.1 Default Alarm Configuration

| | | Alarm State | | |
|-----------------------------|-------------------|-------------|--------------|----------|
| | | Major | Minor | None |
| Tx Alarms | User Configurable | Solid RED | Flashing Red | Log Only |
| DRO out of lock | No | X | | |
| Tx Output Level High | Yes | X | | |
| Tx Output Level Low | Yes | X | | |
| Tx Input Level High | Yes | | X | |
| Tx Input Level Low | Yes | | X | |
| Temperature Alarm | Yes | | X | |
| Tx Simulated Fault | No | X | | |
| 10 MHz Reference Fault | No | | X | |
| Input Voltage Out of Range | No | | X | |
| Switch Fault | No | X | | |
| Input Current Out of Range | No | | | X |
| AGC/ALC Target Out of Range | No | | | X |
| AGC/ALC Out of Range | No | | | X |
| AGC/ALC Not Settled | No | | | X |

You can disable the multifunction LEDs. Use the ASCII command “CLE” described in [Appendix C](#), the “External LED” command described in [Appendix D](#), the hand-held terminal described in [Appendix E](#) to disable the LEDs, or the System Configuration Tab of the Web pages described in [Appendix F](#).

Frequency Shift Keying (FSK) Modem Interface

Several modem brands have the capability to communicate with an IBUC using an FSK signal multiplexed onto the IF output connector with the Tx IF signal and the 10 MHz reference signal. The default configuration for the IBUC is RS485/FSK Mode 1 which enables compatible modems to use “Legacy Binary” mode to communicate with the IBUC. The IBUC is also capable of FSK communication using ASCII mode but requires a modem compatible with this method. Refer to the modem’s documentation for more information about commands and procedures for FSK communication with the IBUC.

FSK and RS485 are tied together by the mode of operation (Legacy Binary or ASCII). Once the mode is selected, both FSK and RS485 will work in the same mode. FSK and RS485 also share a common address. The message formats for both FSK and RS485 are the same. Transmitter link specifications are detailed in [Table 5.2](#) and receiver link specifications are detailed in [Table 5.3](#).

Table 5.2 Transmitter Link Specifications

| | |
|----------------------------|--|
| Frequency | 650 KHz \pm 5% |
| FSK Deviation | \pm 60 KHz nominal (+60 KHz mark) |
| Deviation Tolerance | \pm 50 KHz minimum; \pm 70 KHz maximum |
| Output Level | -5 dBm to -15 dBm |
| Output Impedance | 50 Ω |
| Start Tone | 710 KHz |
| Start Tone Time | 10 ms |

Table 5.3 Receiver Link Specifications

| | |
|--------------------------|----------------|
| Locking Range | \pm 32.5 KHz |
| Input Impedance | 50 Ω |
| Input Sensitivity | -15 dBm |

FSK data is transmitted at 9600 baud with 8 data bits, no parity, no flow control, and one stop bit.

Synchronization is maintained by the following method:

1. Once a character is received and the inter-character time exceeds 20 ms, then the link will reset.
The IBUC is capable of responding to messages at a rate of one every 20 ms.
2. If the IBUC does not respond within the maximum response time, the command should be cyclically repeated.

Note: This synchronization method is true only for Legacy Binary mode (not ASCII).

RS485

The RS485 interface is intended primarily as a network management system (NMS) interface accessed by an NMS program. You can also access the RS485 interface with the host computer by using the host computer's on-board RS485 card or by using an external RS232 to RS485 adapter. You can communicate with the IBUC across RS485 through ASCII or through the binary protocol known as "Legacy Binary."

The RS485 interface is a standard two-wire interface (DATA+ and DATA-). The baud rate is programmable to 1200, 2400, 4800, 9600, 19200, 38400, 57600, or 115200 baud. The data is transmitted asynchronously as 8 bits, no parity, no flow control, and one stop bit.

To configure RS485, you will need to set the following:

- RS485 Address
- RS485 Delay
- RS485 Baud rate
- Legacy Binary or ASCII mode

You can configure RS485 by using any of the M&C interfaces described in this chapter.

ASCII Mode

Because Legacy Binary is the default RS485 setting for the IBUC, you will need to reconfigure the IBUC in order to use ASCII mode. You can specify ASCII mode by using any of the M&C interfaces described in this chapter.

Communication requires an on-board RS485 card in the host computer. However, if an external interface converter box is used to convert RS232 to RS485, a terminal emulation program such as HyperTerminal will not function. In this case, a network management program is required to handle this handshaking requirement.

In HyperTerminal, type the password command, and then press Enter. For example, <001/CPE=1234 where <001/ is the address of the IBUC and 1234 is the default password. When the > prompt re-appears, the IBUC is ready to accept commands.

ASCII Mode Command Format

[Table 5.4](#) lists the differences between SET and GET commands in ASCII Mode.

Table 5.4 ASCII Mode Command Format

| SET Commands | GET Commands |
|---|--|
| Start of Packet: < (ASCII code 60; 1 character) | Start of Packet: < (ASCII code 60; 1 character) |
| Target Address: (4 characters) | Target Address: (4 characters) |
| Address De-limiter: / (ASCII code 47; 1 character) | Address De-limiter: / (ASCII code 47; 1 character) |
| Instruction code: (3 characters) | Instruction code: (3 characters) |
| Code qualifier: = (ASCII code 61 or 63; 1 character) See Appendix C for a list of ASCII codes | End of Packet: Carriage Return (ASCII code 13; 1 character) |

Table 5.4 ASCII Mode Command Format (Continued)

| SET Commands | GET Commands |
|---|--------------|
| Arguments: (<i>n</i> characters) | — |
| End of Packet: Carriage Return (ASCII code 13; 1 character) | — |

For GET Commands, the format is as follows:

`<address/command[CR]`

Example: `<0001/COI{CR}`

For SET Commands, the format is as follows:

`<address/command=XXX[CR]`

Example: `<0001/CPE=1234{CR}`

ASCII Mode Response Format

- Start of Packet: `>` (ASCII code 62; 1 character)
- Target Address: (4 characters)
- Address De-limiter: `/` (ASCII code 47; 1 character)
- Variable Length Data: (*n* characters)
- End of Packet: Carriage Return (ASCII code 13; 1 character)

Example: `>0001/{Variable Length Data}{CR}`

Commands and values available in ASCII mode are shown in the command set in [Appendix C](#).

Legacy Binary Mode

Legacy Binary mode is the default RS485 setting for the IBUC. In Legacy Binary Mode, using the BUCMON program that is included on the CD-ROM which accompanies the unit is the simplest method of communicating with the IBUC. If you do not have access to the BUCMON program, you will need to use a separate network management program.

For the RS485 interface, the packet is encapsulated inside a data link layer packet which has an address “header” byte and a checksum “trailer” byte. [Table 5.5](#) contains the packet format.

Table 5.5 Packet Format

| Byte | Description |
|-------------|---|
| 1 | RS485 destination address of command. For responses, responder address is shifted left by 4 bits. |
| 2 through 6 | Command or response packet data. |
| 7 | CHECKSUM: the sum of bytes should equal zero. |

Each transmitted command data packet consists of the seven bytes shown in [Table 5.6](#).

Table 5.6 IBUC Data Packet Byte Configuration

| Byte 1 | Byte 2 | Byte 3 | Byte 4 | Byte 5 | Byte 6 | Byte 7 |
|--------------|---------|-------------|-------------|-------------|-------------|-----------|
| IBUC Address | Command | Data Byte 1 | Data Byte 2 | Data Byte 3 | Data Byte 4 | Check Sum |

Where

- Byte 1 contains the IBUC address that is being queried.
The IBUC will accept a command only if the first byte contains the appropriate address.
- Byte 2 contains the major command.
See [Appendix D](#) for possible commands.
- Byte 3, Byte 4, Byte 5, and Byte 6 contain the specific command response values.
See [Appendix D](#) for possible command responses.
- Byte 7 contains the algebraic sum of Bytes 1 through 6.
Commands are executed only if the checksum coincides.

For more information about response data packet configuration, see [Appendix D, Legacy Binary Command Message Structure](#).

Ethernet

Using Ethernet, you can communicate with the IBUC through Telnet (ASCII), the onboard Web server (HTTP), or through SNMP. The IBUC uses a static IP addressing structure and does not support DHCP (Dynamic Host Control Protocol).

The IBUC is factory-configured as follows:

| | |
|-------------|---------------|
| IP Address | 192.168.1.21 |
| IP Gateway | 192.168.1.1 |
| Subnet Mask | 255.255.255.0 |
| Telnet Port | 23 |

Note: Your computer should have a static IP address on the same subnet as the IBUC. Using a suitable cable, connect the computer to the J2 connector on the IBUC.

Note: If an Ethernet hub is not used to connect to the IBUC, a crossover cable must be used. However, most current Ethernet cards have an auto-sensing feature which enables the use of a straight connect cable.

Determining the IP Address of Your IBUC or IBUC 2

Follow these steps to determine the IP address of your unit:

1. Attach the 19-pin M&C cable between your computer and the J2 connector of the IBUC.
2. Open a Web browser window and navigate to the Support page of the Terrasat Communications, Inc. website at www.terrasatinc.com/support.htm
3. Double-click the IBUC v1.XX file name, as shown in [Figure 5.2](#).

Note: In [Figure 5.2](#), the version shown is v1.22; your version number may vary.

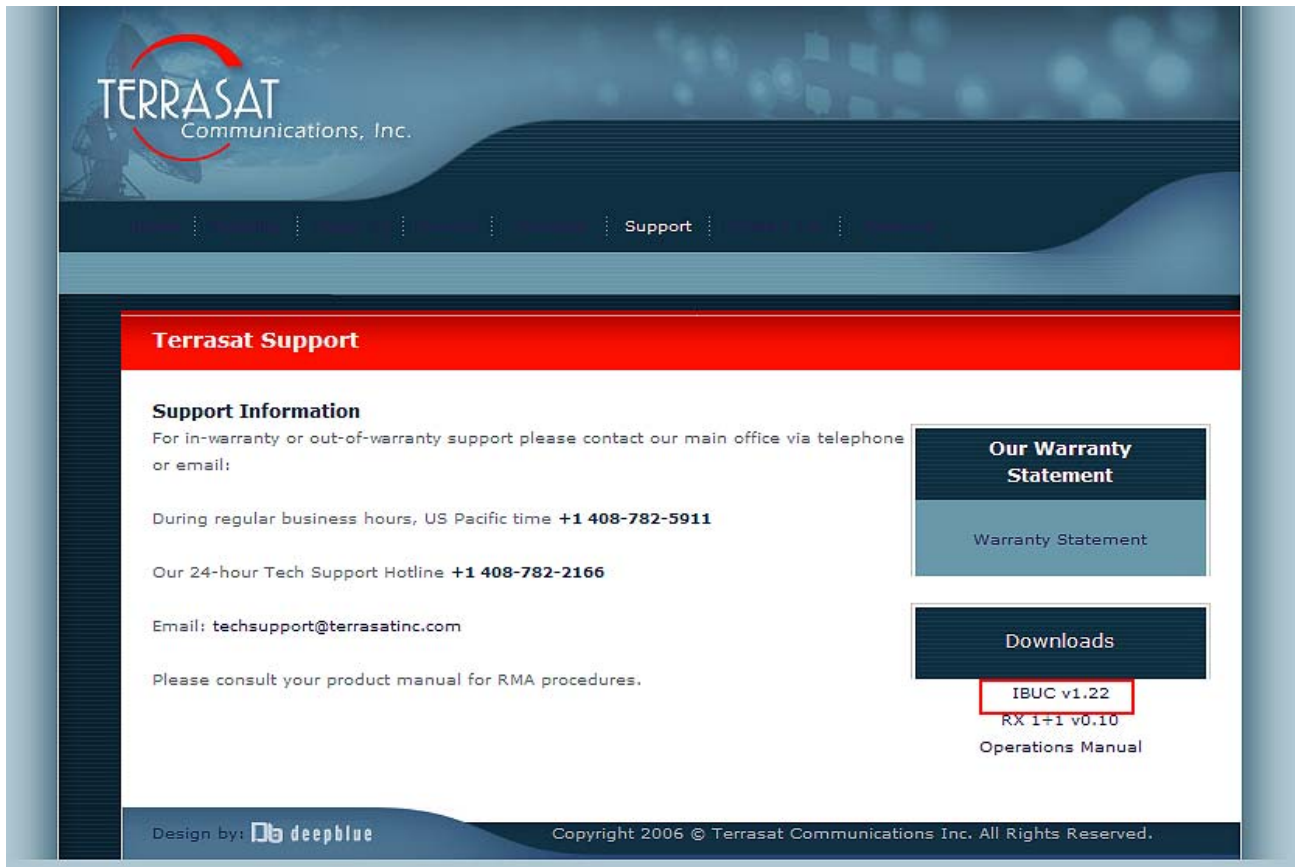

Figure 5.2 Location of Downloads on Terrasat Website

4. After you double-click the file name, a dialog box similar to the one shown in [Figure 5.3](#) appears that asks you whether you want to open or save the .zip file. Click **Open**.



Figure 5.3 Download Instructions for .zip File

5. The contents of the .zip file appear as shown in Figure 5.4. Double-click the file named UDPDownload-2004-09-05.

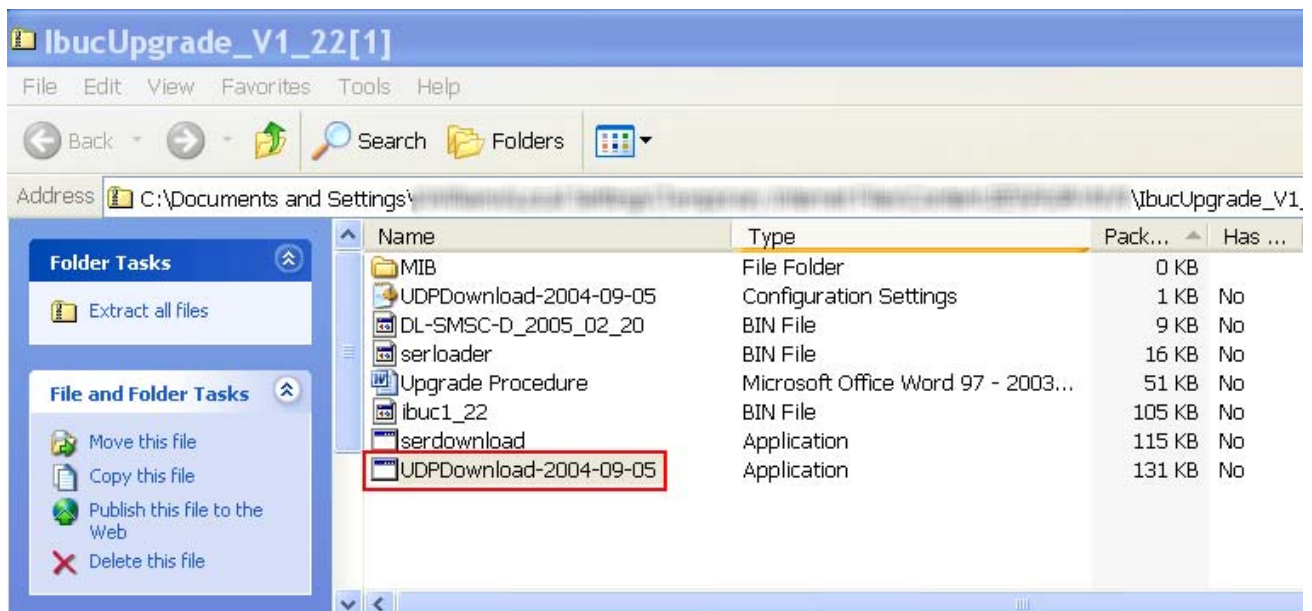

Figure 5.4 Contents of the IBUCUpgrade_v122 .zip File

6. A dialog box similar to the one shown in Figure 5.5 appears. Click **Run**.

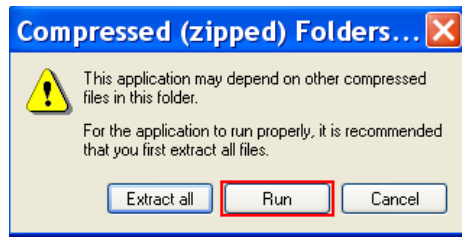

Figure 5.5 Extracting the .zip Files

7. A Security Warning dialog box, similar to the one shown in [Figure 5.6](#), appears. Click **Run**.

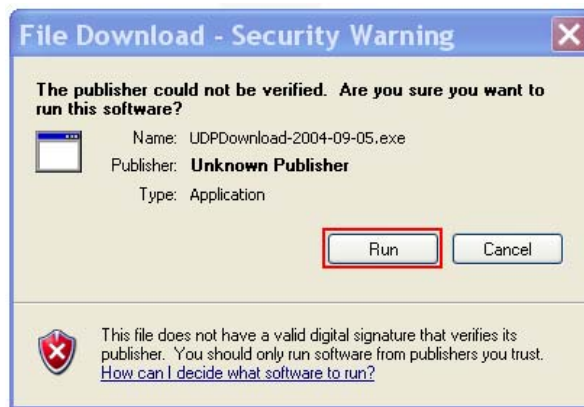

Figure 5.6 Security Warning Dialog Box

8. The program begins to search for the IP address of any connected IBUC that is on the same subnet as the computer, and then displays that information in a window similar to the one shown in [Figure 5.7](#).

Note: Be sure to record the IP address for future reference.

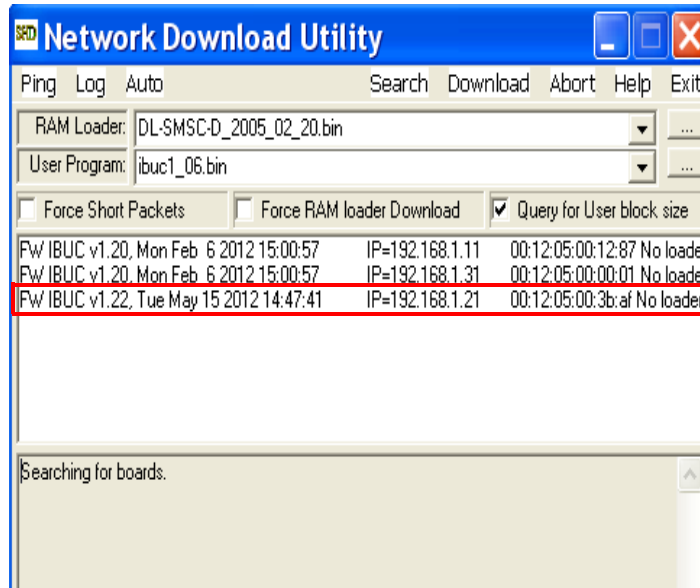

Figure 5.7 Results Window

However, if your unit is not on the same subnet as your computer, your results window will be blank like the one shown in [Figure 5.8](#). Because there are no matches, the message “Searching for boards.” will repeat.

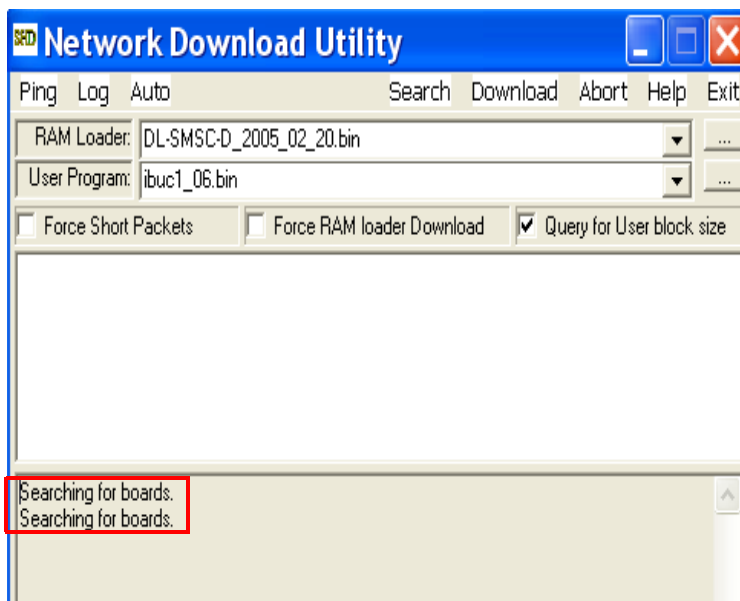

Figure 5.8 Blank Results Window

9. To stop the program, click **Abort**, and then click **Exit**.

You can re-start the program when the unit and the computer are on the same subnet.

Telnet

Telnet is a simple, text-based program that enables you to connect to another computer by using the Internet. You can connect to the IBUC by using a Telnet client from the host PC. Telnet uses the ASCII command set listed in [Appendix C, ASCII Command/Response Structure](#). The default port for Telnet is 23. Characters are echoed back to the user. The response format varies depending on the message setting type. If the verbose setting is used, the response contains formatting characters which display neatly to the user. If the terse setting is used, the response contains no formatting characters and is terminated with LF and CR. If verbose mode is used, the response is terminated with IBUC>.

To initiate a session,

1. Activate a command prompt window from the host computer.
2. Type `Telnet 192.168.1.21` and a cursor should appear on the left of the screen.
3. Type the password command `CPE=1234`.

You can now use ASCII commands to configure and monitor the IBUC. See [Appendix C](#) for more information.

Web Server

You can access embedded Web pages that contain status and configuration information.

Connect to the IBUC M&C and type the IBUC IP address through a Web browser. A login page then appears. After login, you have a choice of eight Web pages (nine pages if using redundant IBUCs) with monitoring, control, and alarm information. Individual pages are displayed by clicking the tabs at the top of the Web page frame. On a redundant transmit system, the display area will contain two frames. The left side will display the A: side IBUC and the right will display the B: side IBUC. See [Appendix F, IBUC Web Pages](#) for Web page layouts.

To initiate a session,

1. Activate a Web browser window from the host computer.
 2. Type the IP Address of the IBUC in the address window, and then press Enter.
- See [Appendix F](#) for more information about the options available on each Web page.

SNMP

The IBUC supports SNMP version 1.0 protocol. The SNMP agent listens on Port 161 for SNMP messages and uses Port 162 for transmitting trap information. SNMP can be configured from the HHT, RS232, Telnet, Web pages, FSK, and RS485 interfaces (ASCII mode required for FSK and RS485).

The MIB-II system group is implemented beginning with version 1.04.

The following commands configure SNMP operation on the IBUC:

- **CIT** – Enables or disables the SNMP trap capabilities of the IBUC.
 - CIT=1 Enable traps. SNMP must be enabled to generate traps (CIS=1).
 - CIT=0 Disable traps.
 - CIT? Displays the current setting of traps.
- **CIS** – Enables or disables the SNMP functionality of the IBUC.
 - CIS=1 Enable SNMPV1.
 - CIS=0 Disable SNMPV1.
 - CIS? Displays the current setting of SNMP functionality.
- **CIH** – Sets the IP address to send traps.
 - CIH=<value> where value is an IP address in dotted decimal notation.
 - CIH? Retrieves the current trap IP address from the IBUC.
- **CIC** – Sets the SNMP passwords for the IBUC.
 - CIC=<public>,<private>,<trap> where public is the public password, private is the private password, and trap is the trap password.
 - All three passwords are required when issuing this command.
 - Each password cannot exceed 16 characters.
 - Passwords may not be read for security purposes.

To configure SNMP using the hand-held terminal (HHT),

1. Connect the HHT to the IBUC by using the 19-pin connector.
2. Press the decimal key four times (e.g.,).
3. Type the password.
The default password is 1234.
4. Press the right arrow key to access the SNMP submenu.
5. Press the 0 key.
6. Press Yes to enable SNMP.

7. Press the Bksp key.
8. Press 1 key.
9. Press Yes to enable traps.
10. Press the Bksp key.
11. Press the 2 key.
12. Type the trap host IP address.

Note: Community strings cannot be set from the hand-held terminal.

To configure SNMP from the Web pages,

1. Connect to the IBUC with a Web browser.
The default IP address is `http://192.168.1.21`.
2. Type the password.
The default password is `1234`.
3. Select the Interface Configuration tab.
4. Enable SNMP, SNMP Trap, host trap IP, and set passwords, if desired.
The default is public, private, and trap.
5. Press Submit.

Note: Changing the SNMP passwords requires a firmware reboot.

MIBs

Management information bases (MIBs) are hierarchical virtual databases used to manage the devices in a communications network. The following MIBs are provided for the SNMP management station:

- TERRASAT-IBUC-MIB.MIB
- TERRASAT-RX1PLUS1-MIB.MIB
- TERRASAT-SMI-MIB.MIB
- TERRASAT-SSPA-MIB.MIB
- TERRASAT-TC-MIB.MIB
- TERRASAT-TRAPDEF-MIB.MIB

MIB files are included on the CD-ROM supplied with each IBUC. The MIB files do not need to be loaded in any particular order.

Power Measurement

The Terrasat IBUC is capable of accurately reading the input and output power for a single carrier in either continuous signal mode (CSM) or in burst mode. The dynamic range for input power is from -55 dBm to -20 dBm and for output power the dynamic range is from rated power to 20 dB below rated power. Each unit is loaded with a detector calibration lookup table that compensates for detector variations in frequency, power level, and temperature. The reported power level is then based on the user-requested frequency and the internally monitored temperature and power level. If multiple carriers are present, the composite transmit power level is read but accuracy is dependent upon the actual carrier frequencies, levels, and modulation being used.

The power measurement occurs in the following two ways:

1. Burst Mode

In burst power measurement mode it is assumed that, in normal operation, a transmit carrier may or not be present due to the nature of burst mode operation. Since the transmit burst pulse has a rise time and a fall time and the envelope level varies during symbol transitions when the signal is modulated, the power must be reported as a peak value. To maintain detected accuracy of the burst pulse, 128 consecutive measurements of the pulse are taken. Once the initial reading exceeds the burst threshold, 128 consecutive readings are taken (regardless of level). The highest value of the 128 is displayed. The IBUC reports the most recent valid reading above the burst threshold.

Burst Time: 500 μ s to 1 s

Measurement accuracy: ± 2 dB absolute, 1.5 dB p-p relative. Accuracy is improved as the burst threshold setting is raised closer to the carrier peak.

The detector accuracy is based on a pulsed unmodulated signal with a pulse width of 500 μ s.

2. Continuous Signal Mode (CSM)

In CSM power measurement mode, it is assumed that, in normal operation, a transmit carrier is always present. Therefore, reported power is the peak power over 128 consecutive readings.

Measurement accuracy: ± 1 dB absolute, 1 dB p-p relative*

The detector accuracy is based on a CW unmodulated carrier.

* Relative measurement accuracy defines the error between any two power readings at any particular frequency over the dynamic range.

Notes: To make the given accuracy achievable, the operating transmit frequency information must be provided via M&C in order to use the information in the detector's internal calibration look-up table.

By default, the unit will be set to perform CSM measurements.

TROUBLESHOOTING

This chapter discusses basic troubleshooting procedures for the Terrasat Communications, Inc. line of intelligent block upconverters (IBUCs) and outdoor units (ODUs).

Maintenance

In general, Terrasat power supply units (PSUIs) and ODUs are self-contained and require little maintenance. However, for optimum performance, Terrasat recommends that users inspect the mechanics of the system every six months and perform the following:

- Clean the antenna feeds to keep them clear of obstructions.
- Check cables and connectors for signs of wear, damage, or loose connections.
- Check all fan intakes and exhausts to ensure that they are clear of debris.

Transceiver Fault Isolation

Use the information in this section to assist in determining whether a Terrasat unit is faulty. The intent is to determine a “Go” or “No Go” situation based on alarms indicated through the M&C ports, as well as by measuring certain signals using test equipment.

AC Power Problems/Conditioning

In today’s electrical environment, there are many types of power-related problems that can prevent proper operation of sensitive electronic equipment. These problems or disturbances can be caused by things such as voltage induced by lightning, switching high-power electrical equipment On/Off, or utility company actions such as power factor correction. Serious problems can arise with the occurrence of transients and spikes which can cause random errors or even failure of the circuitry.

Whatever the origin of the transients, they can be classified into two simple categories:

- **Common Mode**
Noise voltage that appears equally and in phase from each signal conductor to ground.
- **Normal Mode**
Noise potential between the power line conductors. It adds to and subtracts from the power line sinusoidal voltage wave.

Category A

At the wall outlets (and more than 30 ft. [9 m] from a distribution panel), the typical noise is a 0.5 μ s rise time up to 6 kV peak open circuit voltage, 100 kHz ring wave with 200 ampere short circuit current capability.

Category B

At the distribution panel, one can experience the 100 kHz ring wave listed previously but with 500 ampere current capability and a unidirectional impulse up to 6 kV potential rising in 1.2 μ s and decaying to half voltage in 50 μ s. Accompanying this can be a short circuit current up to 3000 amperes rising to peak in 8 μ s and decaying to half value in 20 μ s.

To ensure uninterrupted service, Terrasat recommends using a line conditioner or uninterruptible power supply (UPS) based on the expected AC power at the site.

Site-Related Problems

VSAT antennas are often fitted at the top of buildings. Avoid close proximity to elevator motors, etc. Ensure that the satellite signal path is free and clear of obstructions.

M&C Checks

When troubleshooting the IBUC, the first level of troubleshooting should be to check the status through the M&C port. Alarms and an alarm history log are available with the IBUC M&C. See [Chapter 5, Monitor and Control Features and Functions](#), for specific information about using the RS232, RS485, Ethernet, or hand-held terminal ports.

Power Supply Checks

For DC-powered IBUCs, before beginning RF troubleshooting first verify that the proper voltages are being supplied to the IBUC. Input DC voltage and IBUC current consumption data are available from the IBUC M&C. Verify that the values are within limits. If an M&C interface is not available, use a multimeter to verify that the appropriate voltages (24 VDC, +48 VDC, or -48 VDC) are present at the IBUC.

Check the part number label on the IBUC to determine the required voltage. The IBUC DC supply can be through either the J1 or J3 connector.

Transmit Power Setting

There have been several cases reported to Terrasat Technical Support where the transmit power has been turned up to or near saturation while transmitting a digital carrier. This most likely will result in spectral distortion, re-growth, and intermodulation products for multi-carrier operation. To reduce saturation, reduce the input level or increase the attenuation.

Note: When transmitting digital carriers, it is customary to operate the power amplifier system with an output back off (OBO) sufficient to meet the spectral density mask requirements and interference requirements of multi-carrier operation.

Transmit Intermediate Frequency Input Level Verification

If low or no Tx output power is detected, begin troubleshooting by checking the input to the IBUC.

| | |
|--|--|
|  | <p style="text-align: center; background-color: red; color: black; font-weight: bold; padding: 5px;">WARNING</p> <p>DC power might be present on the cable. Terrasat recommends the use of a DC block.</p> |
|--|--|

1. Check the Tx Input Level displayed in M&C or disconnect the cable at the IBUC J1 connector (Tx L-band) and use a spectrum analyzer to measure the power level of the L-band signal at the output of the coaxial cable that connects to the IBUC at J1 (Tx L-band). The L-band signal level should be within the range of -20 dBm through -55 dBm. If it is not, check the cable and modem output.
2. If the L-band signal is within range, check that the 10 MHz reference signal is within the range of +5 dBm through -12 dBm and is distortion free. If it is not, check the cable and modem output (or IFU Tx Out).
3. For DC-powered IBUCs, if the L-band and 10 MHz signals are good check that the DC voltage level is within range. The DC voltage may be on the L-band IFL or from a separate power supply for 16 watt Ku-band, 25 watt C-band, or 20 watt X-band and lower power units. For higher power units, the DC voltage will be on the DC cable that is connected to the IBUC DC Input (J3 connector). If it is not, check the PSUI, modem, or IFU power supply outputs and cables.
4. For DC-powered IBUCs, if the L-band, 10 MHz and DC voltage signals are within range, continue with the IBUC Tx Output verification procedure that follows.
5. Disconnect the spectrum analyzer from the coaxial cable.

IBUC Transmit Output Verification

This check assumes that the L-band, 10 MHz, and DC inputs (for DC-powered IBUCs) are at the correct levels.

1. Tx Output level is monitored and displayed in the IBUC M&C. Alternatively, you can connect a waveguide-to-coaxial adapter and a 40 dB high-power attenuator to the IBUC Tx waveguide output.
2. Measure the Tx RF output with the spectrum analyzer connected at the waveguide output. Ensure that the cable loss of the cable being used for the measurement has been taken into account.
3. RF power should be between rated power and no lower than 25 dB below rated power. If it is not, the IBUC is defective and should be returned to the factory for repair. See [page 6-7](#) for instructions for returning a unit for repair.
4. IF the IBUC Tx RF output measures within specification, ensure that the waveguide, feedhorn, and antenna are properly aligned.

Receive L-band Output Verification

If low or no RF output power is detected, begin troubleshooting by checking the output of the LNB.

1. Ensure that 15 VDC to 24 VDC (LNB Bias) is present at the modem Rx Input (or IFU Rx In) using a digital voltmeter (DVM). If it is not present, check the cable and modem.
2. Use a spectrum analyzer to ensure that the 10 MHz signal is present at the modem Rx Input (or IFU Rx In). If it is not, check the cable and modem.

| | |
|---|---|
|  | WARNING |
| | DC power might be present on the cable. Terrasat recommends the use of a DC block. |

3. Connect the LNB to the demodulator (or IFU) by attaching the coaxial cables from the Rx L-band Out on the LNB to the demodulator (or IFU) Rx L-band input port. If the Rx level is low, check the cable, the feedhorn, and the antenna for proper operation.

Common Problems

The following problems or occurrences have been noted during normal troubleshooting.

Tx Output is Disabled

When the Tx Output is set to Disabled, the Tx Output level shown on the Sensor Tab on [page F-11](#) reads -99.00 dBm. This is not an actual reading.

However, when conditions cause the automatic shut-off of the Tx Output signal, the Tx Output is muted and the Tx Output level on the Sensor Tab shown on [page F-11](#) reads -96.00 dBm.

Incorrect Frequency Settings

See [page 4-8](#) if the Satellite Network Operations Center (NOC) does not recognize your signal.

Damaged Cables

RF coaxial cable damaged due to improper handling (such as contact damage due to improper mating; cable insulation that is damaged, crushed, cut, or charred; cables were not discharged prior to connecting them; or conductors that are nicked, gouged, damaged, or severed) may impair system performance and reliability. Do not attempt to repair broken or damaged coaxial cables unless absolutely necessary. Replace the entire cable whenever possible.

Damaged cabling and incorrectly tightened connectors can leak RF energy, which may lead to excessive levels in their immediate vicinity.

| | |
|---|--|
|  | CAUTION |
| | <p>Never disconnect RF cables or connectors associated with a transmitter in operation since this may result in an RF burn through direct contact with RF conductors.</p> |

10 MHz Reference Signal at the IBUC is at the Wrong Level or Missing

A 10 MHz input is used to provide a stable reference frequency to which the phase-locked local oscillator (or PLDRO) synchronizes. The 10 MHz reference signal level should be between -12 dBm to +5 dBm.

When the IBUC senses that the phase-locked local oscillator has gone out of lock, a PLDRO Lock alarm is triggered. This alarm then initiates a series of routines that

leads to the muting of the power amplifier (that is, the IBUC is automatically shut-off). [Table 6.1](#) lists four possible scenarios caused by changes in the 10 MHz reference signal or whether the PLDRO is locked.

Table 6.1 Possible Scenarios for IBUCs with an External 10 MHz Reference Signal

| 10 MHz Reference Signal Level | Phase-Locked Local Oscillator | Results |
|-------------------------------|-------------------------------|---|
| Low | Locked | Causes a minor alarm (10 MHz Detector). Unit is still transmitting. Check the 10 MHz signal level. Resultant phase noise may be degraded. |
| Low | Out-of-Lock | Causes a major alarm (PLDRO Out of Lock). Power amplifier is muted and the IBUC is automatically shut-off. Check the 10 MHz reference signal level and whether the 10 MHz reference signal is enabled at the modem. |
| Within Specifications | Locked | Unit is operating normally. No alarms are present. |
| Within Specifications | Out-of-Lock | Causes a major alarm (PLDRO Out of Lock). Power amplifier is muted and the IBUC is automatically shut-off. PLDRO may be faulty and the IBUC might need to be returned for repair. |

Antenna is Pointed Toward Wrong Satellite or is Misaligned

Transmission to the wrong satellite or on the wrong polarization or channel can cause interference with other satellite users and may result in fines from the satellite operator.

To ensure that your antenna is aligned with the correct satellite,

1. Follow the antenna manufacturer’s instructions to verify the azimuth, elevation, and polarization settings.
2. Follow the antenna manufacturer’s instructions to move the antenna into a position that provides maximum signal strength.
3. Establish a communications link with the satellite network operations center (NOC).
4. Verify the aiming of the antenna with the satellite operator.

Moisture Migrated Into the IBUC

Moisture can enter and damage the IBUC if waveguide gaskets are missing, there is a hole in the feed window, or there is a break in the coaxial connectors.

To prevent moisture from entering the IBUC,

- Use water-resistant wrap (or mastic tape) on all outdoor connectors to ensure a water-tight seal. Mastic tapes are designed to flow and self-heal if cut or punctured

See [page 3-24](#) for more information about applying water-resistant wrap.

- Avoid using damaged connectors (for example, scratched mating surfaces, eccentric or bent center conductors, etc.).
- Seal all coaxial cable fittings with putty.

Bad Orthogonal Mode Transducer and/or Antenna

If the antenna feedhorn and orthogonal mode transducer (OMT) are not positioned correctly, the IBUC will not operate properly.

To position the feedhorn and OMT,

- Refer to the antenna manufacturer's assembly instructions to verify that the feedhorn and OMT were mounted correctly on the antenna.
- Establish a communications link with the satellite network operations center (NOC).
- Guided by NOC staff, slowly rotate the outdoor equipment to the appropriate position.

LED is Red

A red LED indicates only that a fault (or alarm) has occurred and does not necessarily indicate that transmission has stopped. A flashing red light indicates a minor alarm and a solid red light indicates a major alarm. You can communicate with the IBUC to determine what is causing the fault, and then clear the fault condition.

1. Establish a connection with the IBUC by using any of the M&C interfaces.
2. View the Alarm Status Tab (shown on [page F-8](#)) to determine the current alarm.
3. View the Sensor Tab (shown on [page F-11](#)) to determine which sensor reading caused the alarm.
4. Compare your readings to the thresholds.
5. Adjust the threshold level(s) to bring the reading(s) within specifications and thus clear the fault

When the fault is cleared, the LED should be flashing green.

Repair Policy

The Terrasat IBUC and PSUI are not field repairable.

In the event that a failure has been detected, it might be necessary to return the defective unit to the factory or a factory-authorized service center. The following section contains instructions for returning a defective unit to the factory for repair.

Returned Material Authorization (RMA)

If any equipment is determined to be defective:

- Have the following information available:
 - Unit serial number
 - Unit part number and description
 - Complete description of the failure
 - Designated contact name and phone number
 - Billing information
 - Shipping information
- Contact Terrasat Customer Service to request an RMA number.
 - Telephone +1 408-782-2166
 - E-mail techsupport@terrasatinc.com
- Properly package the defective equipment in its original container (if available and undamaged), and mark the RMA number on the outside of the shipping container.
- Ship the equipment to the following address:

Terrasat Communications, Inc.
235 Vineyard Court
Morgan Hill, CA 95037
U.S.A.
- After the unit is received at Terrasat, an initial evaluation will be performed.
 - If the unit is found to be in-warranty, the unit will be repaired and returned at no charge.
 - If the unit is found to be out-of-warranty, Terrasat Customer Service will contact the designated contact for authorization to proceed with the repair.
- Authorization in the form of a purchase order will be required.
- Once authorization is received, the unit will be repaired and returned.

IBUC TRANSMIT REDUNDANT SYSTEMS

The IBUC can be installed and configured as a redundant system providing automatic switching to a standby unit in the event of the failure of the primary unit. The outdoor power supplies are configured in pairs to provide full system redundancy.

Description

A transmit redundant (or Tx 1+1) system includes two IBUCs of the same frequency band connected to an interface module and an RF switch. An external power supply (such as the Terrasat PSUI-948, PSUI-1148, or PSUI-1248) is required for each DC-powered IBUC. AC-powered IBUCS can be connected to AC mains. The IBUCs, interface module, and RF switch are typically mounted on a common mounting plate and connected with supplied cables and waveguide components, as shown in [Figure 7.1](#).

Interface for Tx Redundant (1+1) Systems

The Tx 1+1 interface module is a passive unit. This module divides the frequency shift keying (FSK), 10 MHz reference and L-band signals, as well as routes the Ethernet connection to the IBUCs through an Ethernet switch. It supports various interface connectors and includes a bank of LEDs for visual indication of alarm conditions. The user interface is one of the following: via Web browser to embedded Web pages, TCP/IP through a Telnet session, UDP through SNMP, RS485, hand-held terminal, RS232, as well as FSK link to both IBUCs.

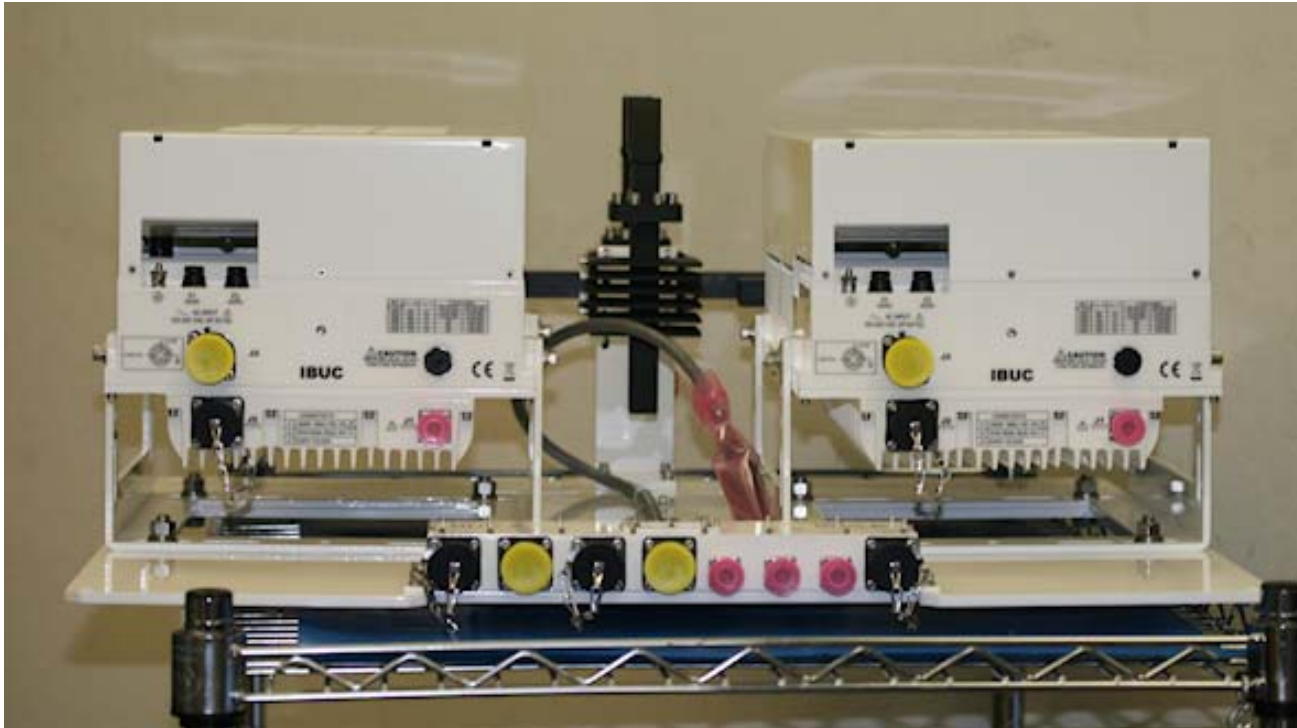

Figure 7.1 Transmit Redundant System Setup

The system provides automatic switching between IBUCs in the event of failure. The IBUCs communicate with each other to monitor status and execute switching logic. A software command is available in the IBUC to enable the unit designated as Master to clone itself to the Slave to match the unit's configuration. Monitor and Control (M&C) functions are available through the interface module via hand-held terminal (one connector for each IBUC), RS232 (one connector for each IBUC – the same as for a hand-held terminal), RS485 (user interface connector), TCP/IP (user interface connector), and FSK (coaxial connection). In the redundant system, remote M&C by using RS485 and TCP/IP is available via the interface module which eliminates the need to run two separate M&C cables to the IBUCs. In the case of FSK, M&C is available on the IFL cable and no additional cables are required. M&C commands for redundant systems are present in the IBUC software. See [Appendix C](#) for more information about ASCII commands.

[Figure 7.2](#) is a diagram of a typical redundant system.

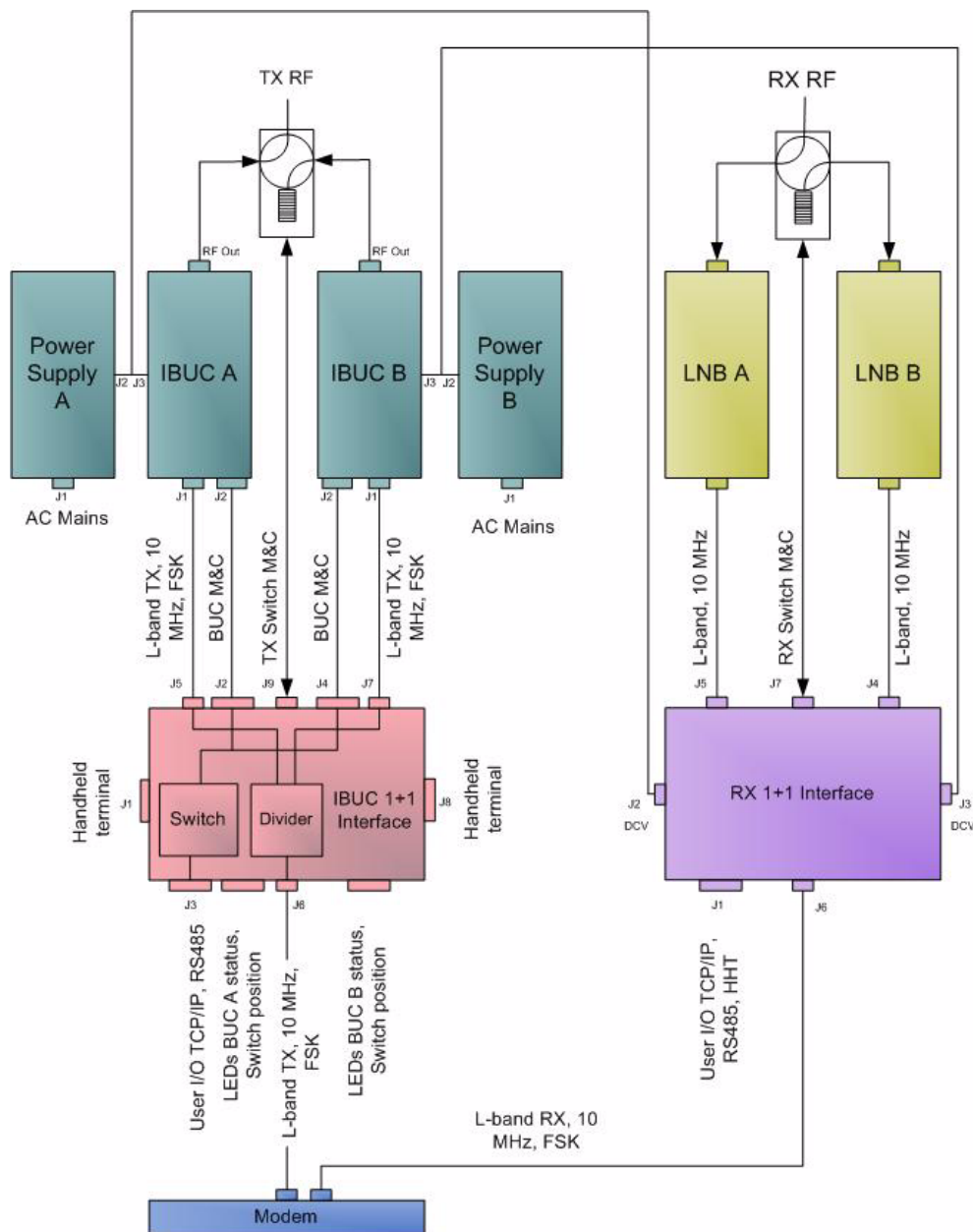

Figure 7.2 IBUC Redundant System Diagram

Component Descriptions

As described previously, the redundant transmit system includes two IBUCs of the same frequency band connected to an interface module at the input and an RF switch at the output. An external power supply is required for each DC-powered IBUC or via AC mains for AC-powered IBUCs. This section explains the functionality of each component and their relationships.

Intelligent Block Upconverter (IBUC)

More information about the intelligent block upconverter is found in [Chapter 2, IBUC Functional Description](#).

Tx 1+1 Interface Module

The Tx 1+1 interface module is powered by both IBUCs through connectors J2 (for the A: side IBUC) and J4 (for the B: side IBUC). Both supply inputs feed a linear regulator that generates the voltage for all internal circuitry. The RS232 interface and the power for the hand-held terminal are all routed to connector J1 (for the A: side IBUC) and J8 (for the B: side IBUC). The RS485 interfaces coming from both IBUCs via connectors J2 and J4 are connected together and routed to the user interface via connector J3. The Ethernet ports from the A: side IBUC and the B: side IBUC (connectors J2 and J4, respectively) are routed to the user interface through an internal Ethernet switch. The alarm output (normally open, faulted, or short to ground) of the A: side IBUC is routed to the alarm input of the B: side IBUC and vice-versa. This setup ensures that the A: side IBUC and the B: side IBUC monitor each other. Also, the other side of the Form-C relay with the alarms of both IBUCs are routed to the interface via connector J3. The switch commands from the A: side IBUC and the B: side IBUC are connected together and routed to the waveguide switch (connector J9). The waveguide switch indicators (connector J9) are routed to both IBUCs (connectors J2 and J4). The Tx Input (L-band, 10 MHz and FSK) from connector J6 is routed to a splitter (it also blocks DC, if present at J6). The outputs of the splitter are routed to connector J5 (the A: side Tx output) and J7 (the B: side Tx output). The Tx 1+1 module also has a bank of LEDs that provide a visual indication of the power, Ethernet activity for both IBUCs and the user interface, status of both IBUCs, as well as which IBUC is online.

[Figure 7.3](#) is a block diagram of a Tx 1+1 interface module.

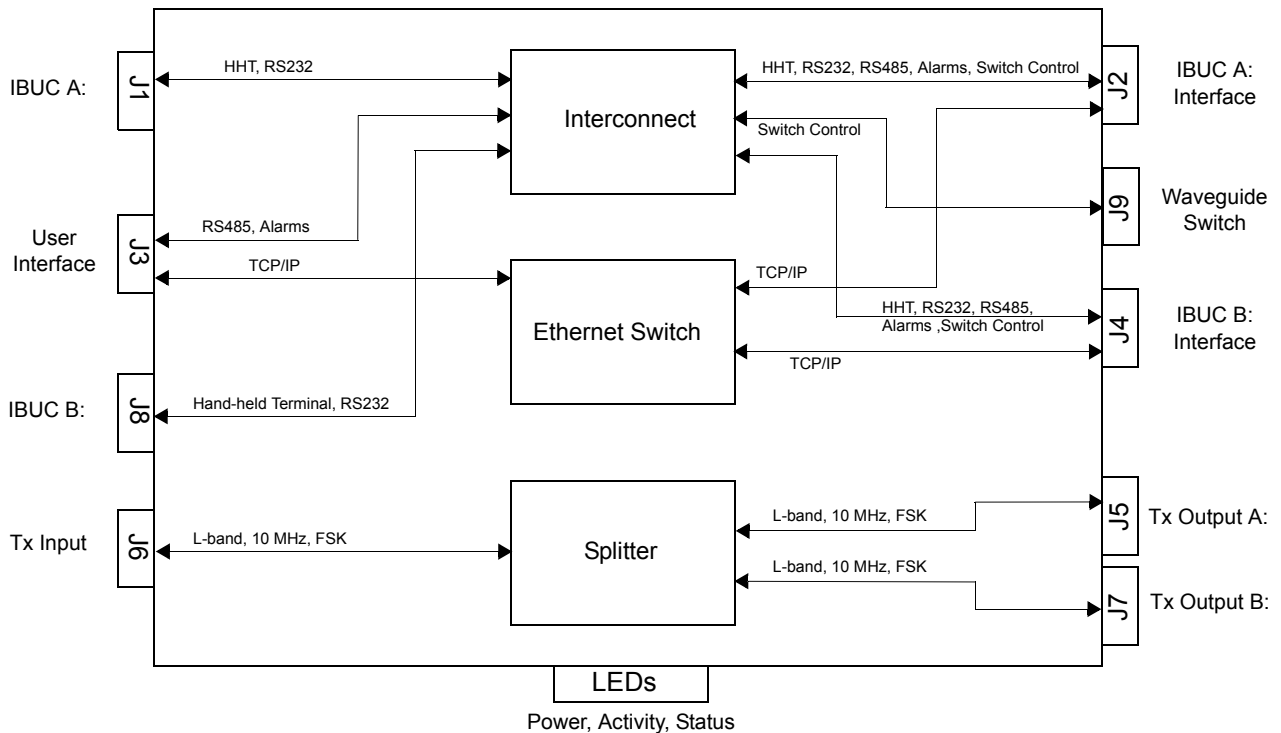

Figure 7.3 Tx 1+1 Interface Module Block Diagram

Waveguide Switch

Redundant systems are provided with the waveguide switch. A switch cable, which is used to connect the Tx and Rx Interface to the switch, is also included.

Software

Both Tx and Rx redundant systems monitor and control several parameters and have features to simplify installation and use of the redundant systems as well as enhance system performance.

Some of the key features include:

- Monitor and Control

Redundant systems can be monitored and controlled through an assortment of interfaces including RS232, RS485, Ethernet port, an optional hand-held terminal or via an FSK link with compatible modems.

- Tx Redundancy

The IBUCs automatically sense when they are configured in redundancy mode. The logic for redundant operation is built-in, eliminating the need for an external switching controller.

- Autocloning

The Master IBUC (online) periodically updates the Slave IBUC (standby) with configuration data. This enables users to configure the system by configuring only the Master IBUC. The Slave IBUC then becomes a “clone” of the Master when autocloning is enabled.

- Embedded Web pages

Provide management for small networks by using a Web browser.

- Alarm History

A log of alarms that occur is maintained. This can simplify troubleshooting of the system—especially if an intermittent problem occurs.

For a full description of M&C functions, see [Chapter 5, Monitor and Control Features and Functions](#).

Installation and Setup

The redundant Terrasat outdoor unit (ODU) consists of two IBUCs, redundant power supplies, and a set of interconnection cables. It can also include an Rx 1+1 redundant system.

This section contains the general requirements for installation of the ODU to the antenna.

| | |
|---|--|
|  | WARNING |
| | For protection of personnel and equipment, use care when installing the antenna and whenever working on or around the system. |
| | Follow standard safety precautions when using hand and/or power tools. |

Use care when working with dangerous voltages.

System Cabling Requirements

Interfaces

Tx 1+1 System

Both the A: side IBUC and the B: side IBUC connect to the interface module via a coaxial cable connection (J1) carrying the L-band, 10 MHz reference and FSK M&C signals, where appropriate. A second connector on the IBUC (J2) connects to the interface module that provides the M&C interface. IBUC waveguide outputs are connected to ports on the Tx RF switch using waveguide bends. DC power (48 VDC) is provided from separate power supplies to each DC-powered IBUC at connector J3. AC power is provided via AC mains for AC-powered IBUCs at connector J3.

The Tx waveguide switch provides the uplink signal to the antenna feed via a waveguide (customer supplied) or coaxial cable, as required. Power and switching control are carried on an interface cable from the switch to the interface module.

The interface module provides nine connectors for interfacing the IFL, the IBUC RF switch, and M&C functions. Status LEDs built in to the interface module provide visual system status, as shown in [Figure 7.4](#). Remote M&C for the 1+1 system is available via separate M&C cables by using RS485 or TCP/IP. Systems with FSK-capable modems also have M&C functions available at the modem's front panel. Local monitoring and control is available by using a hand-held terminal connected at the interface module.

Tx 1+1 Interface Module

[Figure 7.4](#) depicts the top view of an interface module of a Tx 1+1 system and identifies the locations of the various connectors.



Figure 7.4 Tx 1+1 Interface Module Top View

Physical Connections

Table 7.1 contains information about the various interface connectors and their mates for a Tx 1+1 Interface Module.

Table 7.1 Tx 1+1 Interface Module Connector Schedule

| Reference Designator | Function | Interface Connector | Interface Connector Mate |
|----------------------|------------------------------------|--|---|
| J1, J8 | RS232 and HHT | AMPHENOL CIRCULAR, BOX MTG SOCKET, 19S (PT02E14-19S (027)) | AMPHENOL CIRCULAR, STRAIGHT PLUG, 19P (PT06F14-19P (476)) |
| J2, J4 | M&C INTERFACE | AMPHENOL CIRCULAR, BOX MTG SOCKET, 19P (PT02E14-19P (027)) | AMPHENOL CIRCULAR, STRAIGHT PLUG, 19S (PT06F14-19S (476)) |
| J3 | USER INTERFACE | AMPHENOL CIRCULAR, BOX MTG SOCKET, 19S (PT02E14-19S (027)) | AMPHENOL CIRCULAR, STRAIGHT PLUG, 19P (PT02F14-19P (076)) |
| J5, J7 | Tx OUT | TYPE-N, SOCKET | TYPE-N, PLUG |
| J6 | Tx IN | TYPE-N, SOCKET | TYPE-N, PLUG |
| J9 | WAVEGUIDE SWITCH CONTROL/INDICATOR | AMPHENOL CIRCULAR, BOX MTG SOCKET, 6S (PT02E10-6S (027)) | AMPHENOL CIRCULAR, STRAIGHT PLUG, 6P (PT3116F10-6P) |

A mating M&C connector for J3 is provided with the Tx 1+1 system.

Terrasat offers a range of outdoor PSUIs to support all IBUC power levels. Power supplies have an auto-ranging AC front end that will work with both 115 VAC and 230 VAC. The outdoor PSUI is shipped with a DC power cable (5 ft) and mating connectors for the AC mains power cable.

RS232, HHT, and Alarm J1 and J8

The RS232, HHT, and Alarm connector is a 19-pin circular connector used to enable monitoring and control of the IBUCs operating parameters. Pin assignments are shown in Table 7.2. The J1 connector enables monitoring and control of the A: side IBUC and the J8 connector enables monitoring and control of the B: side IBUC.

Table 7.2 Pin Assignments for RS232, HHT, and Alarm Connectors J1 and J8

| Pin | Function |
|-----|------------------------------|
| A | N/C |
| B | N/C |
| C | HAND-HELD TERMINAL POWER (+) |
| D | RS232 RXD |
| E | RS232 TXD |

Table 7.2 Pin Assignments for RS232, HHT, and Alarm Connectors J1 and J8 (Continued)

| Pin | Function |
|-----|-------------------|
| F | HHT, RS232 Common |
| G | N/C |
| H | N/C |
| J | N/C |
| K | N/C |
| L | N/C |
| M | N/C |
| N | N/C |
| P | N/C |
| R | N/C |
| S | N/C |
| T | N/C |
| U | N/C |
| V | N/C |

M&C Interface J2 and J4

The M&C Interface connectors are 19-pin circular connectors used to enable the IBUCs to exchange communication and status, as well as monitor and control the waveguide switch. Pin assignments are shown in [Table 7.3](#). The M&C cables used to connect the Tx 1+1 interface module to the IBUCs are supplied with the Tx 1+1 System.

Table 7.3 Pin Assignments for M&C Interface Connectors J2 and J4

| Pin | Function |
|-----|---------------------------------|
| A | RS485 (+) |
| B | RS485 (-) |
| C | HAND-HELD TERMINAL POWER (+) |
| D | RS232 RXD |
| E | RS232 TXD |
| F | HHT, RS232 Common |
| G | TCP/IP TX+ |
| H | TCP/IP TX- |
| J | TCP/IP RX+ |
| K | TCP/IP RX- |
| L | IBUC ALARM OUTPUT Normally Open |
| M | IBUC ALARM OUTPUT Common |

Table 7.3 Pin Assignments for M&C Interface Connectors J2 and J4 (Continued)

| Pin | Function |
|-----|-----------------------------------|
| N | IBUC ALARM INPUT |
| P | IBUC ALARM OUTPUT Normally Closed |
| R | 1+1 SWITCH COMMAND A |
| S | 1+1 SWITCH COMMAND B |
| T | 1+1 SWITCH INDICATOR A |
| U | 1+1 SWITCH INDICATOR A |
| V | 1+1 REDUNDANCY ENABLE |

User Interface J3

The User Interface connector is a 19-pin circular connector used to enable remote monitoring and control of the Tx 1+1 System operating parameters. Pin assignments are shown in [Table 7.4](#). If the user interface port of the Tx 1+1 interface module is going to be used, the cable should be a shielded multi-conductor cable with at least two each twisted pairs. The twisted pairs used for TCP/IP must have an impedance of 100 ohms. See also the cable drawings in [Appendix G](#). An assembled IP cable is available from Terrasat.

Table 7.4 Pin Assignments for M&C Interface Connector J3

| PIN | FUNCTION |
|-----|-----------------------------------|
| A | RS485 (+) |
| B | RS485 (-) |
| C | N/C |
| D | N/C |
| E | N/C |
| F | Common |
| G | TCP/IP TX+ |
| H | TCP/IP TX- |
| J | TCP/IP RX+ |
| K | TCP/IP RX- |
| L | IBUC A ALARM OUTPUT Normally Open |
| M | IBUC A ALARM OUTPUT Common (GND) |
| N | N/C |
| P | IBUC B ALARM OUTPUT Normally Open |
| R | IBUC B ALARM OUTPUT Common (GND) |
| S | N/C |
| T | N/C |
| U | N/C |

Table 7.4 Pin Assignments for M&C Interface Connector J3 (Continued)

| PIN | FUNCTION |
|-----|----------|
| V | N/C |

Transmit Output J5 and J7

The Tx Output connectors are Type-N connectors used to connect the IF at L-band from the Tx 1+1 interface module to the IBUCs. Use 50 Ω cables to connect to J5 and J7. These cables are supplied with the Tx 1+1 system. The Tx 1+1 interface module also supplies the IBUCs with the FSK signal and the 10 MHz reference connectors J5 and J7.

Transmit Input J6

The Tx Input connector is a Type-N connector used to connect the IF at L-band from the modem. Use 50 Ω cables to connect to J6. The modem also supplies the FSK signal and the 10 MHz reference for the IBUCs through this connector.

Waveguide Switch Control/Indicator J9

The waveguide switch control/indicator connector is a 6-pin circular connector used to enable the Tx 1+1 system to monitor and control the waveguide switch. The cable that connects the Tx 1+1 interface module and the waveguide switch is supplied with the system.

Cable and Waveguide Connections

| | |
|---|--|
|  | WARNING |
| | Ensure that all power is disconnected prior to making these connections. |

When installing the cable and waveguide assemblies, ensure that all connections are weather tight. If the optional Rx reject filter is being used, attach it to the Tx Redundancy waveguide output. Ensure that proper gasketing is used to prevent water damage.

Water-Resistant Wrap

Terrasat recommends applying water-resistant wrap (such as mastic tape) to all outdoor connectors to prevent water entry and subsequent water damage. Mastic tapes are designed to flow and self-heal if cut or punctured. When applied spirally with the proper tension, mastic tapes form a tight, continuous coating that permits little or no

moisture absorption or penetration. Terrasat provides water-resistant sealing tape for Type-F and Type-N connectors.

Apply the mastic tape, as follows:

1. Ensure that all connectors are firmly tightened; dry; and free from all grease, dust, and dirt.
2. Cut the mastic tape to the desired size. The tape should be long enough to cover the connector completely.
3. Center the tape on the connector to be sealed and wrap the tape in a tight spiral around the connector using a 50% overlap. Squeeze the tape tightly and ensure that both ends of the tape have formed around the connector and the cable without any gaps.

Apply the tape to all connectors that may be exposed to moisture.

Waveguide Connection

Connect a section of flexible waveguide between the OMT transmit port and the Tx Redundancy Tx RF Output (or optional Rx reject filter). The waveguide should be attached to the antenna feed according to the manufacturer's instructions. Ensure that proper gasketing is used to prevent water damage.

Typical Configuration

1. Connect the IFL coaxial cable between the Tx 1+1 Interface Module J6 (Tx L-band In) and the Modem.
2. Connect the coaxial cable between the Rx 1+1 Interface Module J6 (Rx L-band) and the Modem L-band Rx Input.
3. Connect the M&C cable between the Tx 1+1 Interface Module J3 (User Interface) and the appropriate M&C computer or LAN connection.
4. Connect the DC cable between the outdoor PSUI J2 (DC Output), as appropriate, and the IBUC A and B J3 (DC Input).
5. Connect the AC cable between the PSUI J1 (AC Input) and the AC power source.

Grounding

Antenna Recommendations

Most antenna masts are encapsulated in concrete. Typically, the mast pipe is submerged in a 4 ft to 5 ft (1.22 m to 1.53 m) deep augured hole. This provides a good Ufer ground. An Ufer ground, in this case, is defined such that concrete retains moisture for 15 to 30 days after rain or snow melt. Concrete absorbs moisture quickly, yet retains moisture for a period of time. The concrete's large volume and great area of contact with the surrounding soil enables a good transfer to the ground.

In the concrete base, an Ufer ground can be established by running a #4 gauge solid wire or rebar and connecting with pigtailed to the base of the pedestal.

The Ufer ground is only one step in proper grounding. The Ufer ground should be augmented with coupled pairs of 10 ft (3.05m) rods, placed 20 ft (6.1m) into the ground, spaced 20 ft (6.1m) apart. The first rod should be placed close to the antenna. The second rod should be placed towards the equipment enclosure. Connect the rods and antenna mount with a #2 gauge wire. A ground rod should be placed at the equipment enclosure as well. If it is virtually impossible to install the ground rods, then radials are needed. This can be accomplished by laying 10 or more lengths of 1½-in. (3.81cm) copper strap, at least 50 ft (15.24m) long, in a radial fashion around the antenna base. The straps should be buried, if possible. The hub must be interconnected to the utility ground.

The ground configuration can vary from one location to another. It is best to measure the soil conductivity and design a 5 ohm ground system. To protect the system from a direct strike, a lightning rod placed 2 ft (61 cm) higher than the highest point of the dish should be interconnected to the Ufer ground with #2 gauge copper wire.

Tx Redundancy/PSUI Grounding Recommendations

Grounding and lightning protection is recommended as follows.

- **Cable Shielding**

The shield currents can be eliminated with proper techniques. A grounding strap at the end of the coaxial and data cables should be connected to the ground lug at the antenna base with a #4 gauge copper wire. This provides a path of least resistance prior to entering the electronic equipment.

- **AC**

The best way to protect the equipment is to have two protectors. The first is the power mains protector that is mounted directly across the mains in the breaker box. The second should be mounted or grounded directly at the base or hub of the antenna or at the 19-in. rack.

- **Data and Control Lines**

The I/O lines can deliver surge current to the equipment and should be protected as well.

- **Electrical grounding**

Grounding the IBUC and PSUI units is recommended to prevent possible damage from lightning and/or other induced electrical surges. Terrasat recommends that 3/0 or 4/0 AWG (American Wire Gauge) stranded copper wire be used to bond the IBUC and the PSUI to the earth ground (grounding rod), using the most direct (or shortest) route.

System Alignment and Operation

General

The following sections outline the procedure for setup and alignment of the earth station. Prior to ODU alignment, the antenna should be set to the desired azimuth and elevation settings per manufacturer's instructions.

| | |
|---|---|
|  | CAUTION |
| | <p>The Transmit Redundant System must not transmit until alignment and any necessary adjustments are complete.</p> |

Test Equipment

Terrasat recommends the equipment or its equivalent listed in [Table 7.5](#) for installation and system alignment.

Table 7.5 Recommended Test Equipment

| Equipment | Type |
|---|---|
| Spectrum Analyzer | Agilent HP8563E |
| Digital Voltmeter | Fluke 8050 |
| Waveguide-to-coaxial Adapter | C-band or Ku-band |
| RF cables | With calibrated insertion loss up to 15 GHz |
| 40 dB attenuator | High-power to match HPA output. |
| Assortment of cables, connectors and adapters (calibrated up to 15 GHz) | |

Ensure that the Tx output power is disabled to prevent accidental transmission interference with adjacent satellites or transponders before attempting to align or performing any other operation involving the ODU. Before attempting any system change, carefully evaluate the possible effects of the transmitted signal.

Setting the Tx Frequencies

All transmit and receive frequencies are set by using the modem.

For a direct connection to an L-band modem, follow the manufacturer's instructions on setting the transmit and receive frequencies.

Tx Power Alignment

Transmit L-band Input Adjustment with Modem or Converter

| | |
|--|----------------|
|  | WARNING |
| <p>DC power might be present on the cable. Terrasat recommends the use of a DC block.</p> | |

To set the power level of the modulator output:

1. Use a spectrum analyzer to measure the power level of the L-band signal at the output of the coaxial cable that connects to the Tx 1+1 Interface Module at J6 (Tx L-band).
2. Use the modem or converter level adjust to increase and decrease the power level. Adjust to reach a level of -24 dBm (this will result in rated power at the IBUC output).
3. Check that the 10 MHz reference signal is within the range of +5 dBm to -12 dBm.

Note: The IBUC requires a 10 MHz reference signal to operate. Check the model number of the IBUC to determine whether an external 10 MHz signal is required.

4. Disconnect the spectrum analyzer from the coaxial cable.

Transmit RF Output Adjustment with Modem or Converter

To adjust the power level of the IBUC transmitter output:

1. Connect a waveguide-to-coaxial adapter and a 40 dB high-power attenuator to the waveguide output.
2. Connect the Tx L-band input signal to J6 (Tx L-band) on the Tx 1+1 Interface Module.
3. Enable the Tx signals in the modem or converter and the IBUCs.
4. Measure the RF output with a power meter connected at the waveguide output. For greatest accuracy, measure pure carrier (that is., continuous wave or CW) and the frequency allotted to you by the satellite network operations center.
5. With a satellite modem: Adjust the RF output to the designated power level (provided by the satellite network operations center or its engineering staff) with

the L-band output (modem) level adjust. Do this for both systems (A: side and B: side). Equalize the gains by using the gain setting control of the IBUCs.

Note: There are differences between the units and the autocloning feature doesn't transfer the attenuator settings from the Master to Slave.

6. Disable the Tx signal in the modem or converter.
7. Disconnect the Tx L-band input signal.
8. Remove the waveguide-to-coaxial adapter and install the transmit waveguide section to the antenna transmit feed.
9. Once the transmit input and output power levels have been set, connect the Tx L-band input signal to J6 on the Tx 1+1 Interface Module and enable the Tx in the modem or converter. Begin transmitting.
10. Under the guidance of the network operations center, fine-adjust the transmit power for the desired downlink margin at the receiving station by adjusting the Tx L-band output level adjust (modem or converter output).

Final Checks

To ensure optimum operation, inspect the system for crimped or pinched cabling. Make sure all connections are secure. Once the system has been aligned and is operating satisfactorily, it will require infrequent and simple maintenance procedures as described in [Maintenance](#) on [page 6-1](#).

M&C Setup

Tx Redundant System

Default Values

A: SIDE IBUC

RS485 Data Rate is 9600 baud

RS485/FSK Mode is 1 (Legacy Binary mode)

Default IP address is 192.168.1.21

Other (standby) BUC IP address is 192.168.1.22

IP gateway address is 192.168.1.1

B: SIDE IBUC

RS485 Data Rate is 9600 baud

RS485/FSK Mode is 1 (Legacy Binary mode)

Default IP address is 192.168.1.22

Other (standby) BUC IP address is 192.168.1.21

IP gateway address is 192.168.1.1

Note: RS485/FSK Mode 1 is the default setting to enable compatible modems to use the "Legacy Binary" mode to communicate with the IBUC.

General

You can communicate with the redundant system via any of the following five interfaces: TCP/IP, RS232, RS485, hand-held terminal (HHT), and FSK link. The HHT/RS232 connections can be found on connector J1 for the A: side unit, and connector J8 for the B: side unit. The IP/RS485 connections can be found on connector J3. These can be connected to with an appropriately configured cable and terminal. The FSK link uses FSK signals between the IBUC and modem that are multiplexed on the IFL coaxial cable.

TCP/IP

You can communicate with the IBUC via TCP/IP through Telnet (ASCII) or the onboard Web server (HTTP). The IBUC uses a static IP addressing structure and does not support DHCP. The IBUC1+1 is factory-configured as follows:

A: SIDE IBUC

IP Address 192.168.1.21

Other BUC IP Address 192.168.1.22

IP Gateway 192.168.1.1

Subnet Mask 255.255.255.0

Telnet Port 23

B: SIDE IBUC
IP Address 192.168.1.22
Other BUC IP Address 192.168.1.21
IP Gateway 192.168.1.1
Subnet Mask 255.255.255.0
Telnet Port 23

Note: Your computer should have a static IP address on the same subnet as the IBUC 1+1 system. Using a suitable cable, connect the computer to the J3 connector on the IBUC 1+1 system.

Note: If an Ethernet hub is not used to connect to the IBUC 1+1 system, then a crossover cable must be used. An Ethernet hub will function with a straight connect cable. See the attached drawing on [page G-4](#).

Telnet

On the host computer, activate a command prompt window. Type `Telnet 192.168.1.21` for the A: side IBUC or `Telnet 192.168.1.22` for the B: side IBUC and a cursor should appear on the left of the screen. Type the password command, `CPE=1234`, and the response will be `IBUC>_`. Commands can now be entered to access the IBUC functionality. For more information, see [Chapter 5, Monitor and Control Features and Functions](#).

Web Server

On the host computer, activate a Web browser window. In the address window, type `http://192.168.1.21` and then press Enter. Within a few seconds, a login screen appears. Type the password in the dialog box (the default is 1234), and then click Login. The page that appears is split with the A: side IBUC on the left side of the browser window and the B: side IBUC on the right side of the browser window. From the Info tab, you can select from the following Web pages:

- Alarm
- Sensor
- Transmit Config
- Interface Config
- System Config
- Alarm Config
- Redundancy Config
- Alarm Log

The Sensor tab enables monitoring of various IBUC parameters. Alarms are color coded with green indicating OK, yellow as a warning, and red as an alarm condition.

The “Configuration” pages provide access for changing factory default settings to suit specific site or network requirements. Settings take effect only when you click Save Settings. Note that some changes in configuration will cause a loss of communication with the host computer. It will then be necessary to make the corresponding change in the host computer.

For example, to change a unit’s IP address (using the default settings):

1. Navigate to the “Interface Config” page.
2. Change the IP address to something other than 192.168.1.21 (the factory default).
3. Click Save Settings.

Note that IP address changes take effect immediately.

4. In the host computer Web browser, type the new address and come back in through the Login page.

RS232

No additional configuration of the IBUC Tx 1+1 system is required for proper RS232 operation. Connect a suitable cable to connector J1 for the A: side IBUC and connector J8 for the B: side IBUC. The RS232 port uses ASCII protocol and a fixed baud rate of 9600 for communication. On the host computer set the serial port settings to the following: Baud rate to 9600, data bits to 8, parity to none, stop bits to 1, and flow control to none. The IBUC can be accessed using a terminal emulation program on the host computer such as HyperTerminal. See [Appendix B, Using HyperTerminal](#) for information about how to connect using HyperTerminal. Press Enter several times and you should see the “IBUC>” prompt. Type CPE=1234 and the IBUC> prompt should return. The IBUC is now ready to accept commands.

The following two examples use the default settings. If it is necessary to reconfigure these settings, these examples describe the sequence of events:

To configure TCP/IP, set the following:

```
A: Side IBUC
CIA=192.168.1.21 // IP Address
CIB=192.168.1.22 // Other IBUC IP Address
CIG=192.168.1.1 // IP Gateway
CIM=24 // Subnet Mask
CIP=23 // Telnet Port
```



```
B: Side IBUC
CIA=192.168.1.22 // IP Address
CIB=192.168.1.21 // Other IBUC IP Address
CIG=192.168.1.1 // IP Gateway
CIM=24 // Subnet Mask
CIP=23 // Telnet Port
```

To configure RS485, set the following:

```
A: Side IBUC
C4A=1 // RS485 Address
C4D=20 // RS485 Delay
C4R=9600 // RS485 Baud rate
If ASCII mode is desired type
C4M=0 // RS485 Mode (Not factory default)
If Legacy mode is desired type
C4M=1 // RS485 Mode
```

```
B: Side IBUC
C4A=2 // RS485 Address
C4D=20 // RS485 Delay
C4R=9600 // RS485 Baud rate
If ASCII mode is desired type
C4M=0 // RS485 Mode (Not factory default)
If Legacy mode is desired type
C4M=1 // RS485 Mode
```

RS485

Communicating with the IBUC across RS485 can be through ASCII or a proprietary binary protocol known as Legacy Binary.

ASCII Mode

The default configuration is Legacy Binary mode so you will need to reconfigure the IBUC in order to use ASCII mode. ASCII mode can be selected by using any of the M&C interfaces.

Communication through a terminal emulation program such as HyperTerminal requires an on-board RS485 card in the host computer. In HyperTerminal, type the password command: <0001/CPE=1234 for the A: side IBUC and <0002/CPE=1234 for the B: side IBUC, and then press Enter. When the < prompt reappears, the IBUC is ready to accept commands. In the previous example, <0001/ is the address of the IBUC followed by the desired command.

If an external box is used to convert RS232 to RS485, a terminal emulation program will not function. These boxes are designed to work with the RTS/CTS lines manually which a terminal program cannot handle. In these cases, a network management program is required to handle this handshaking requirement.

Legacy (Binary) Mode

The default setting of the IBUC is Legacy Binary mode. In this mode, using the BUCMON program supplied on the Terrasat CD accompanying the unit is the simplest method to communicate with the IBUC. Otherwise, a network management program must be provided.

Hand-held Terminal

No additional configuration of the IBUC is required to use the hand-held terminal (HHT). To activate the HHT, connect the supplied cable to the IBUC connector labeled J1 for the A: side IBUC or J8 for the B: side IBUC and plug the phone jack into the HHT. Once a flashing cursor is seen in the upper left of the screen, press the decimal key on the HHT four times to activate the HHT. The login screen will appear. Type the default password of 1234.

More information about the hand-held terminal menu tree can be found in [Appendix E, IBUC Hand-held Terminal Menu Tree](#).

FSK Link

Several brands of modem are capable of communicating with an IBUC using an FSK signal multiplexed onto the IF output connector along with the Tx IF signal and 10 MHz reference. This enables the operator to monitor and control the IBUC from the modem front panel. The IBUC default configuration is RS485/FSK Mode 1 (Legacy Binary mode) since all modems currently require this protocol for FSK links. The IBUC is also capable of FSK communication using ASCII mode but requires a modem compatible with this method. Refer to the modem's documentation for commands and procedures for FSK communication with the IBUC.

Multifunction LEDs

There are eight LEDs mounted on the Tx 1+1 interface module housing to provide visual indication of IBUC status. [Figure 7.5](#) depicts the locations of the LEDs.

LED colors and modes are as follows:

Flashing Green - No Alarms

Flashing Red - Minor Alarm being reported

Steady Red - Major Alarm being reported

Major and Minor alarms are defined in Chapter 5 of the *Operations Manual*. Note that certain alarms are configurable – enabling you to define them as Major or Minor.

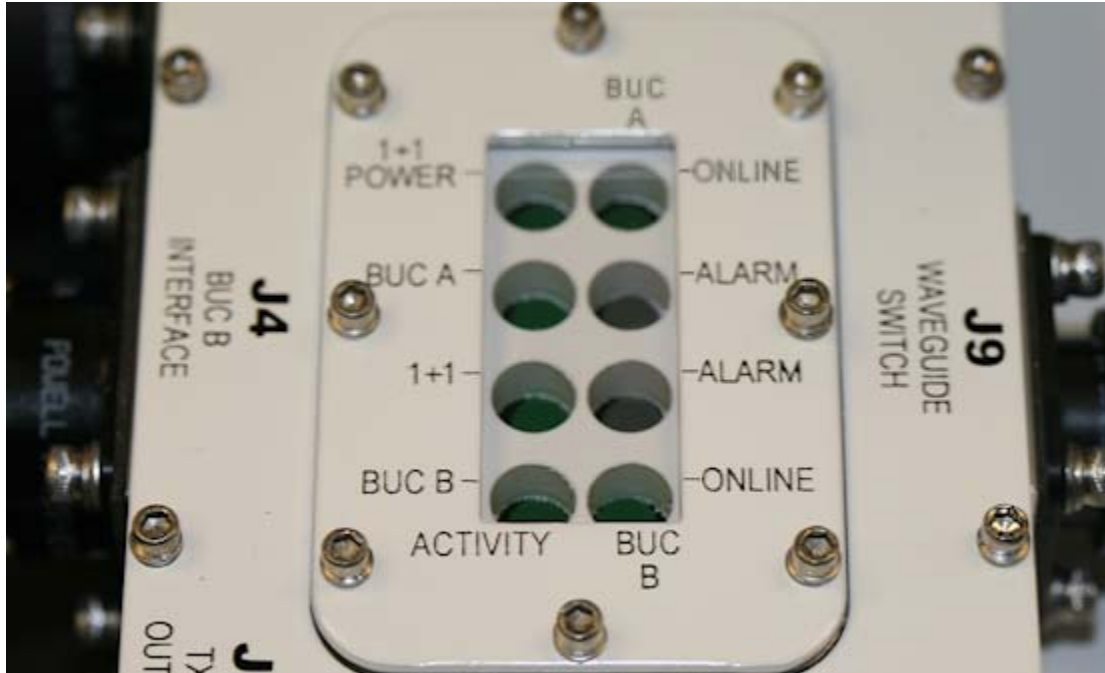

Figure 7.5 Multifunction LEDs for a Tx 1+1 System

The eight LEDs include:

1+1 Power – indicates power is supplied to the unit.

IBUC A: Activity – indicates Ethernet activity on the A: side IBUC.

1+1 Activity – indicates Ethernet activity on User Interface port.

IBUC B: Activity – indicates Ethernet activity on the B: side IBUC.

IBUC A: ONLINE – indicates that the A: side IBUC is transmitting the Tx signal to the antenna.

IBUC A: ALARM – Red indicates a Major alarm is present for the A: side IBUC. Green indicates OK.

IBUC B: ALARM – Red indicates a Major alarm is present for the B: side IBUC. Green indicates OK.

IBUC B: ONLINE – indicates that the B: side IBUC is transmitting the Tx signal to the antenna.

Mechanical Interface

TTx redundant systems are mounted on a mounting plate to facilitate installation. The interface module, two IBUCs, and the Tx RF switch with associated cables and waveguide are mounted on a single plate. Power supply units are mounted on a similar plate that is meant to be mounted close to the IBUC system. See [Appendix G](#) for outline drawings of the redundant mounting system.

Service and Maintenance

The Terrasat redundant systems are self-contained units that require very little maintenance.

Standard Maintenance

For optimum performance, inspect the mechanics of the system every six months. Clean the antenna feeds as necessary to keep them clear of obstructions and check the cables and connectors for signs of wear, damage or loose connections. Check all fan intakes and exhausts to ensure that they are free and clear of debris.

Fault Isolation

Transceiver Fault Isolation

The information contained in this section should suffice in determining whether a Terrasat redundant system is faulty. The intent is to determine a “GO” or “NO GO” situation based on alarms indicated through the M&C ports, as well as measuring certain signals using test equipment.

AC Power Problems/Conditioning

In today's electrical environment there are many types of power-related problems that prevent proper operation of sensitive electronic equipment. These noise problems or disturbances can be caused by such things as voltage induced by lightning, the switching on/off of high-power electrical equipment, or utility company actions such as power factor correction. Serious problems can arise with the occurrence of transients and spikes causing random errors, or even failure of the PSUI circuitry. Whatever the origin of the transients, they can be classified in two categories:

- **COMMON MODE:** The noise voltage that appears equally and in phase from each signal conductor to ground.
- **NORMAL MODE:** The noise potential between the power line conductors. It adds to and subtracts from the power line sinusoidal voltage wave.

Category A

At the wall outlets (and more than 30 ft from a distribution panel), the typical noise is a 0.5 microsecond rise time up to 6 kV peak, open circuit voltage 100 kHz ring wave with 200 ampere short circuit current capability.

Category B

At the distribution panel, equipment can experience the 100 kHz ringwave but with 500 ampere current capability and a unidirectional impulse up to 6 kV potential rising in 1.2 μ s and decaying to half voltage in 50 μ s. Accompanying this can be a short circuit current up to 3000 amperes rising to peak in 8 μ s and decaying to half value in 20 μ s.

To ensure uninterrupted service, Terrasat recommends the use of a line conditioner and/or UPS based on the expected AC power at the site.

Site-Related Problems

VSAT antennas are often fitted on top of buildings. Avoid close proximity to elevator motors, etc. Also ensure that the satellite signal path is free and clear of obstructions.

M&C Checks

When troubleshooting redundant systems, the first level of troubleshooting should be to check the status through the M&C ports. Alarms and an alarm history are available. Refer to this chapter for specific information when using the RS232, RS485, Ethernet, or hand-held terminal ports.

Power Supply Checks

For DC-powered IBUCs, before starting RF troubleshooting first verify that the proper voltages are being supplied to the Tx and Rx Redundant Systems. Input DC Voltage and current consumption data are available from the M&C. Verify that values are within limits. If M&C is not available, use a multimeter to verify that the appropriate voltages (24 VDC or 48 VDC) are present at the IBUC and Rx 1+1 Interface Module. The part number label on the IBUCs contains the required voltage (24 VDC or 48 VDC).

Transmit Power Setting

There have been several cases where the transmit power has been turned up to or near saturation while transmitting a digital carrier. This most likely will result in spectral distortion, re-growth, and intermodulation products for multi-carrier operation.

When transmitting digital carriers, it is customary to operate the power amplifier system with an output back off (OBO) sufficient to meet the spectral density mask requirements and the interference requirements of multi-carrier operation.

Tx IF Input Level Verification

If low or no Tx output power is detected, start the troubleshooting by checking the input to the Tx Redundant System. Use the following procedure:

1. Check the Tx Input Level displayed in M&C or disconnect the cable at the IBUC A and B J1 (Tx L-band) and use a spectrum analyzer to measure the power level of the L-band signal at the output of the coaxial cable that connects to the IBUCs at J1 (Tx L-band). The L-band signal level should be between -20 dBm and -55 dBm. If it is not, check the cable and modem output.
2. If the L-band signal is good, check that the 10 MHz reference signal is between +5 dBm and -12 dBm and is distortion free. If it is not, check the cable and modem output (or IFU Tx OUT).
3. If the L-band and 10 MHz signals are good, check that the DC voltage level is within range (for DC-powered IBUCs). The DC voltage will be on the DC cable that is connected to the IBUCs J3 (DC Input) connector. If it is not, check the PSUI outputs and cables.
4. If the L-band, 10 MHz, and DC voltage (for DC-powered IBUCs) signals are good, proceed to the Tx Redundancy Output verification.
5. Disconnect the spectrum analyzer from the coaxial cable.

Tx Redundancy Output Verification

This check assumes that the L-band, 10 MHz, and DC inputs (for DC-powered IBUCs) are at the correct levels.

1. Tx Output level is monitored and displayed in the IBUC M&C.
Alternatively, you may connect a waveguide-to-coaxial adapter and a 40 dB high-power attenuator to the Tx waveguide output.
2. Measure the Tx RF output with the spectrum analyzer connected at the waveguide output. Ensure that the cable loss of the cable being used for the measurement has been taken into account.
3. The RF power should be between rated power and rated power -25 dB. If it is not, the IBUC is defective and should be returned to the factory for repair.
Terrasat's [Repair Policy](#) on [page 6-7](#) has information about returning a defective unit to the factory.
4. If the IBUC Tx RF output measures good, check the waveguide, feedhorn and antenna for proper operation.

Common Problems

The following common problems or occurrences have been noted during normal troubleshooting:

- Supply voltage at IBUC is low or missing
- 10 MHz reference at the IBUC is at the wrong level or missing
- 10 MHz phase noise does not meet the minimum requirements
- Antenna is misaligned
- Bad OMT and/or antenna
- Damaged cables
- Antenna on the wrong satellite
- Tx L-band input level is misadjusted or turned off
- Water in the IBUC due to no gasket in the waveguide or a hole in the feed window.
- Water in the coaxial connectors
- Incorrect frequency settings

Repair Policy

The Terrasat transmit redundant systems are not field repairable.

In the event that a failure has been detected, it may be necessary to return the defective unit to the factory. Terrasat's [Repair Policy](#) on [page 6-7](#) has instructions for returning a defective unit to the factory.

M&C Functions

The Tx and Rx redundant systems are designed to provide an interface for user configuration and control of the systems. In the Tx system, the IBUCs monitor status can initiate switching when required. The unit on the B: side can be commanded to clone itself to the unit on the A: side. This ensures that the B: side IBUC is configured identically to the A: side IBUC. M&C features are available via the interface module enabling a single point of control for both IBUCs. Commands and alarms unique to the redundancy systems are built-in to the IBUC M&C software.

The interface module includes an Ethernet hub to enable users to monitor and control both IBUCs in TCP/IP with a single Ethernet connection and cable.

For remote operation, the redundant systems are equipped with a Monitor and Control function. The M&C function includes an FSK modem interface, an RS232 interface,

an RS485 interface, a hand-held terminal, an Ethernet interface, multifunction LEDs, and one alarm relay closure (Form-C).

User Interfaces

- **Tx and Rx Systems:** A bank of LEDs provide visual indications of Tx 1+1 and Rx 1+1 status.
- **Hand-held Terminal (HHT):** An optional item that can be used to access the Tx and Rx Systems for local M&C via ports J1 (the A: side IBUC) and J8 (the B: side IBUC) for Tx Systems and port J1 for Rx Systems. The HHT has a 4-row x 20-column display with four function keys (F1-F4), a numeric keypad (0-9), and YES, No, BKSP (backspace), SPACE, and ENTER keys. Initiate the HHT session by typing “....” (4 dots), followed by the password. The default password is 1234. [Figure 7.6](#) depicts the HHT.

The HHT menu consists of a main menu with multiple submenus. Access the submenus by entering the corresponding digit displayed on the HHT display. To maneuver back to the previous screen, press the BKSP (backspace) key. Some screens (for example, INFO) only display information whereas other screens require user input. User input fields are reflected by the corresponding digit and a colon (such as 0:) as shown in the HHT Menu Tree on [page E-3](#) for Tx systems.

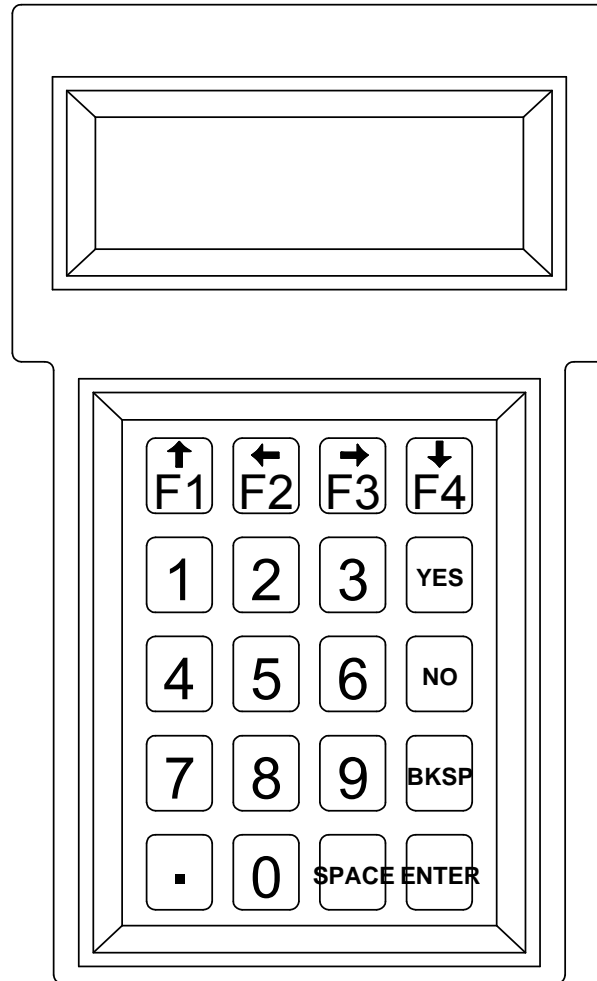

Figure 7.6 Hand-Held Terminal

- **FSK:** FSK is multiplexed onto the IF cable by means of an FSK-modulated signal. FSK for redundancy commands operates only in ASCII mode. See [Appendix C](#) for more information about commands and values available in ASCII mode for Tx redundant systems. FSK and RS485 are tied together by the mode of operation (Legacy-binary or ASCII). Once the mode is selected, both will work in the same mode.

See [Chapter 5](#) for more information about FSK specifications.

- **RS485:** Two-wire half-duplex which is on a separate cable. There are two modes of operation for RS485 interface: ASCII mode and Legacy-binary mode. Commands for redundant systems are available only in ASCII mode.

RS485 in ASCII Mode

The RS485 interface is a standard two-wire interface (DATA+, DATA-). The baud rate is programmable to 1200, 2400, 4800, 9600, 19200, 38400, 57600 or 115200 baud. The data is transmitted asynchronously at 8 bits, no parity, 1 stop bit.

Basic protocol:

| | |
|---------------------|--|
| Start of Packet: | < (ASCII code 60; 1 character) |
| Target Address: | (4 characters) |
| Address De-limiter: | / (ASCII code 47; 1 character) |
| Instruction code: | (3 characters) |
| Code qualifier: | = (ASCII code 61 or 63; 1 character) |
| Optional arguments: | (<i>n</i> characters) |
| End of Packet: | Carriage Return (ASCII code 13; 1 character) |

Example: <0001/CPE=1234{CR}

Commands and values available in ASCII mode for Tx Redundant Systems can be found in [Appendix C](#).

TCP/IP via Ethernet Cable

The Ethernet port is a highly integrated Ethernet Controller which offers an NE2000-compatible adapter with full-duplex and power-down features. The full-duplex function enables simultaneous transmission and reception on the twisted-pair link to a full-duplex Ethernet switching hub. The Ethernet interface is connected through an isolation transformer and filter.

For the Ethernet interface, the packet is encapsulated in several layers (TCP segment inside of an IP datagram inside of an Ethernet frame). The Ethernet MAC address is preset at the factory – each IBUC has a unique MAC address. The IP address, network mask, default route, DNS server, and TCP listen port are configurable through the hand-held terminal interface. The IBUC controller does not support DHCP.

The command set for Tx Redundant Systems RS232, RS485, FSK, TCP/IP and hand-held terminal is provided in [Appendix C](#).

- M&C using TCP/IP is displayed in embedded Web pages. Users connect to the redundant system M&C and type one of the IBUC IP addresses through a Web browser (for Tx Redundancy). After login, you have a choice of Web pages with monitoring, control, and alarm information. For Tx redundant systems, the screen splits in half with information for both the A: side IBUC and the B: side IBUC.

This page intentionally left blank
for double-sided printing.



PART NUMBERING SCHEMA

The charts in this appendix illustrate the part numbering schema used for Terrasat Communications, Inc. products.

Identifying the Part and Serial Numbers

Figure A.1 illustrates the difference between the unit's part number and serial number.



Figure A.1 Identifying the Part and Serial Numbers

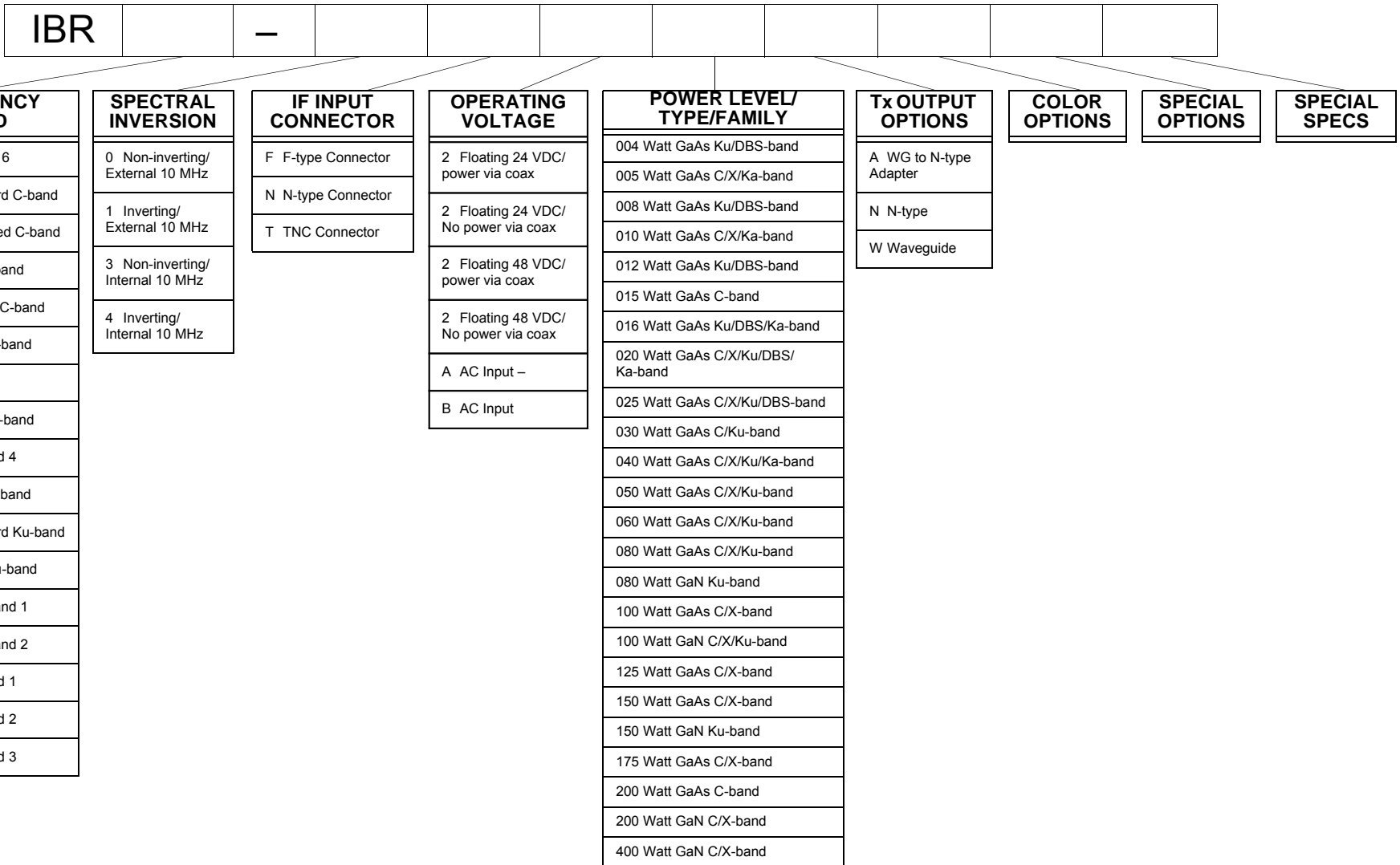

Figure A.2 Part Numbering Schema for IBUC 2s and IBRs

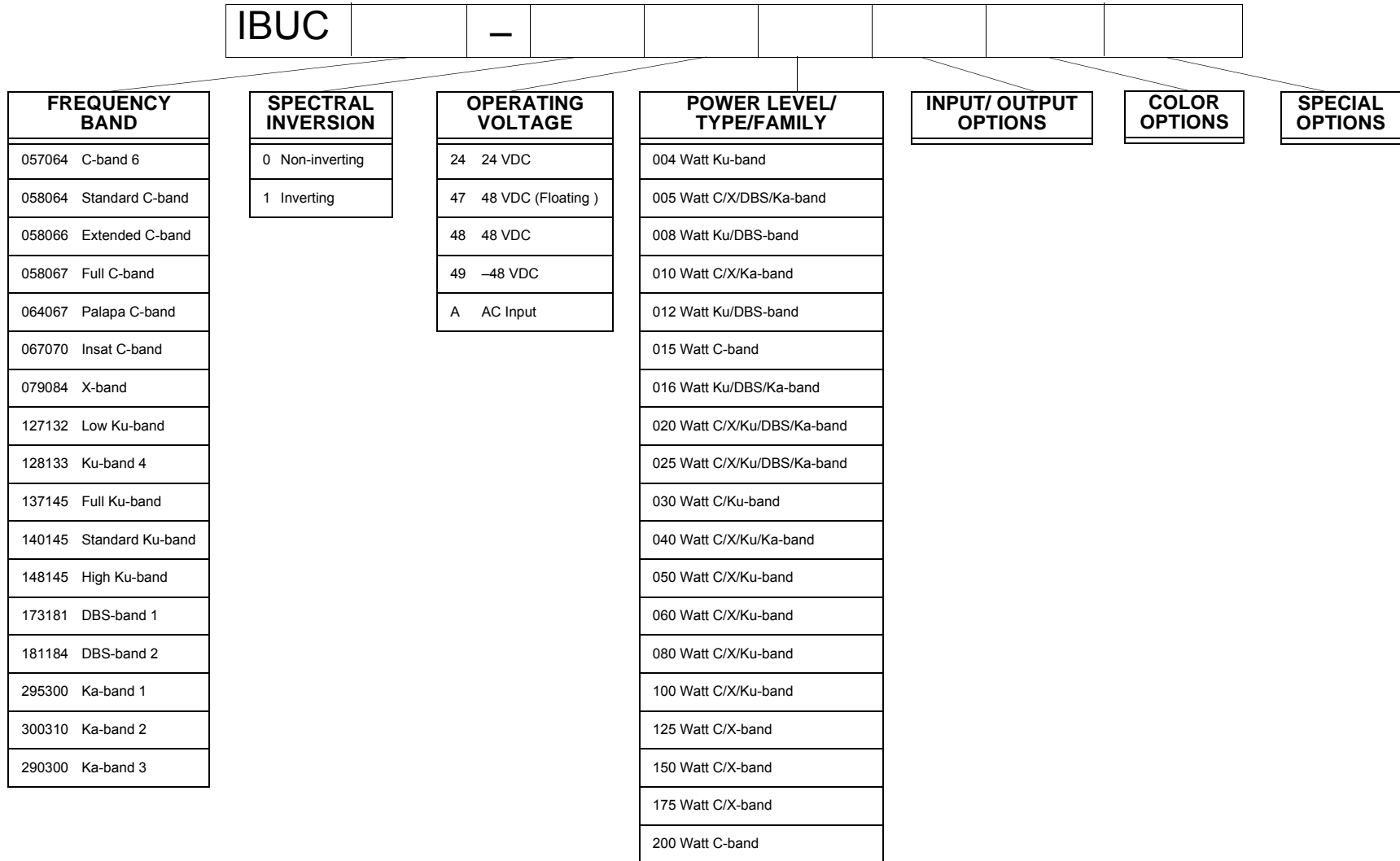

Figure A.3 Part Numbering Schema for IBUCs

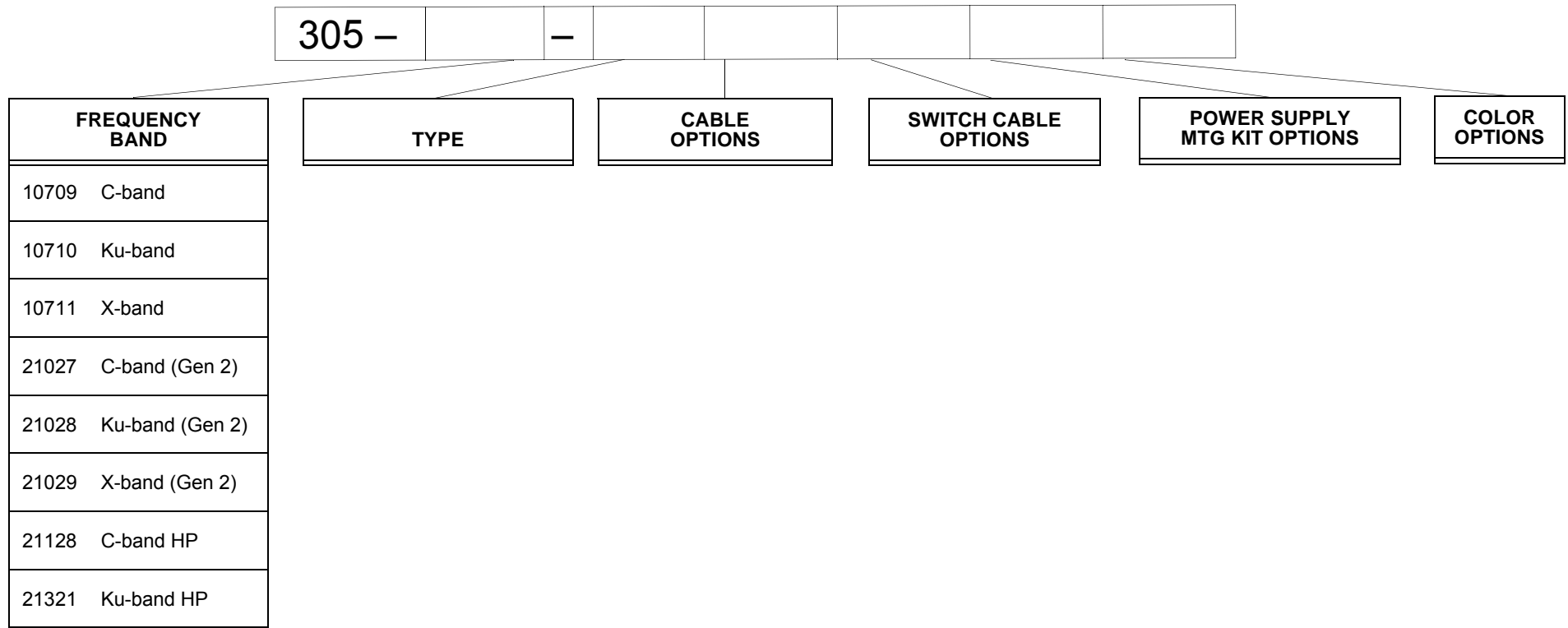

Figure A.4 Part Numbering Schema for Transmit Redundant (Tx 1+1) Systems

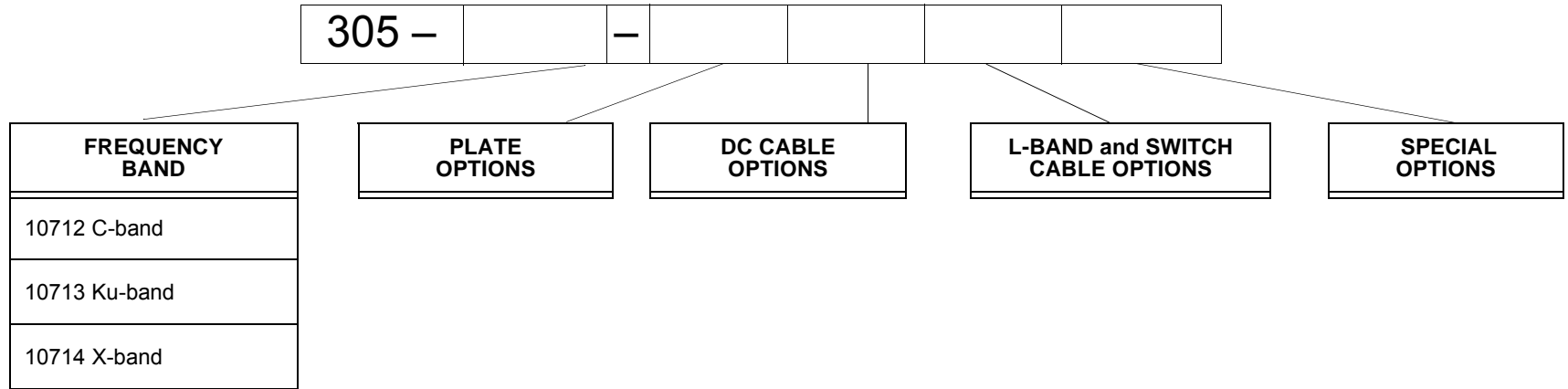

Figure A.5 Part Numbering Schema for Receive Redundant (Rx 1+1) Systems

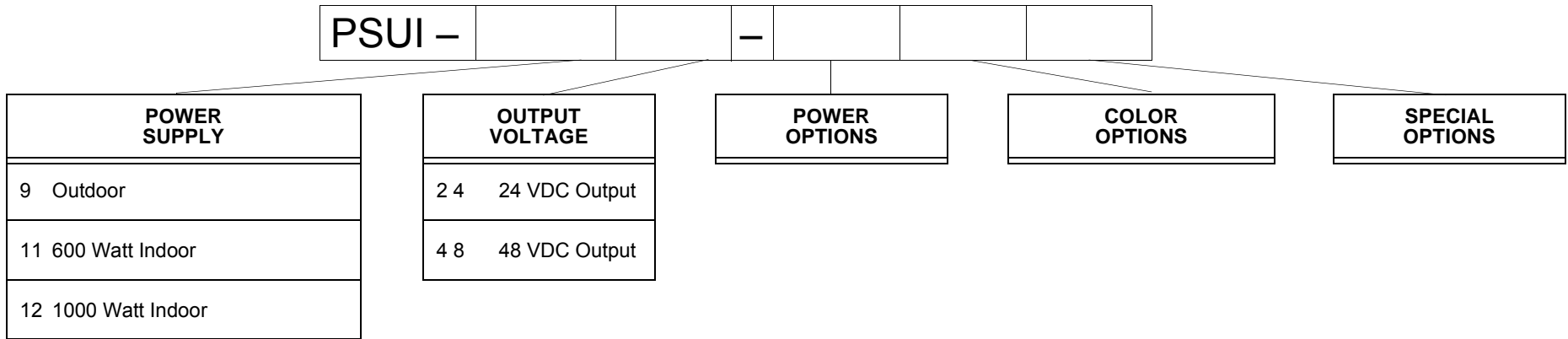

Figure A.6 Part Numbering Schema for IBUC with PSUI Systems

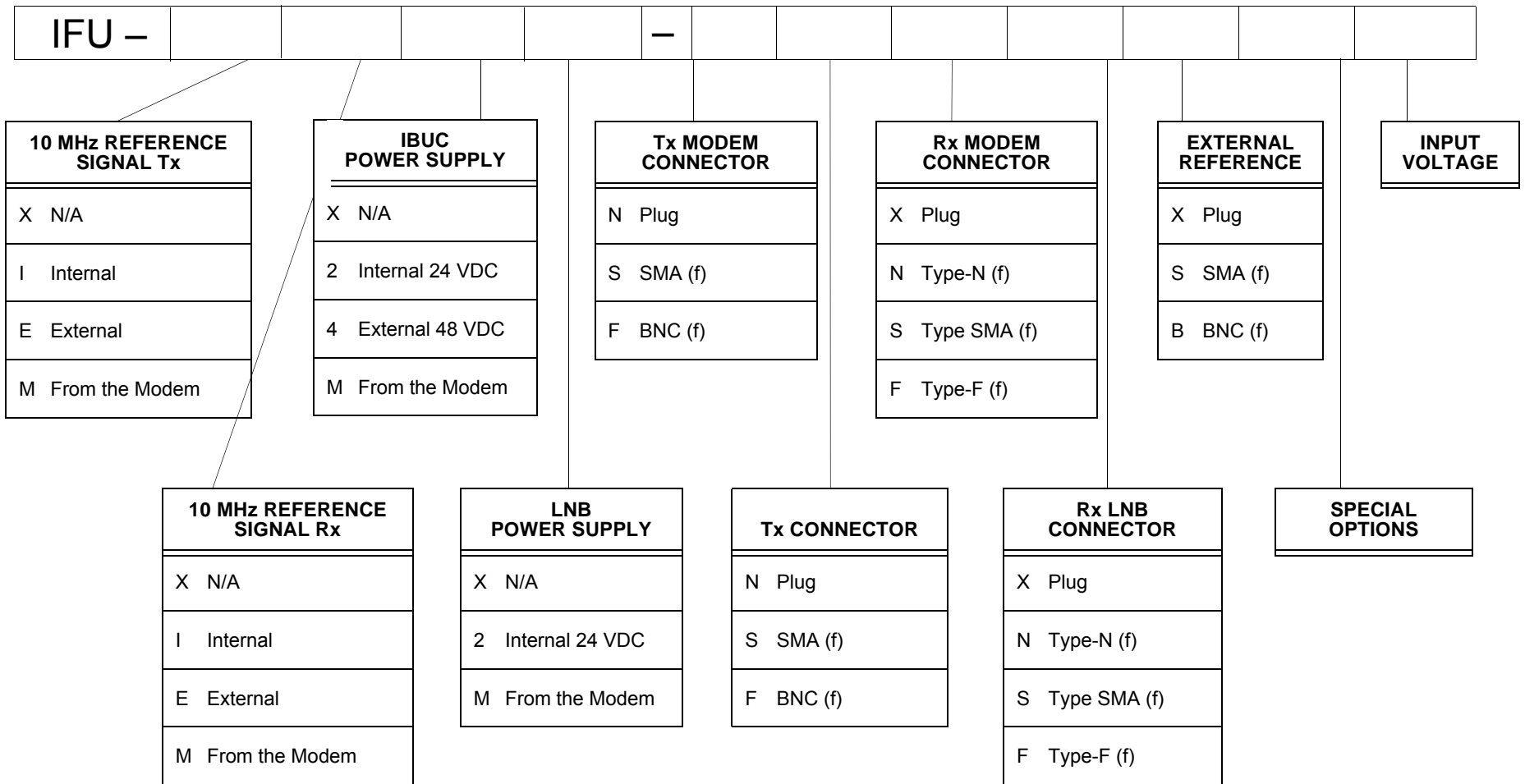

Figure A.7 Part Numbering Schema for IFU Systems

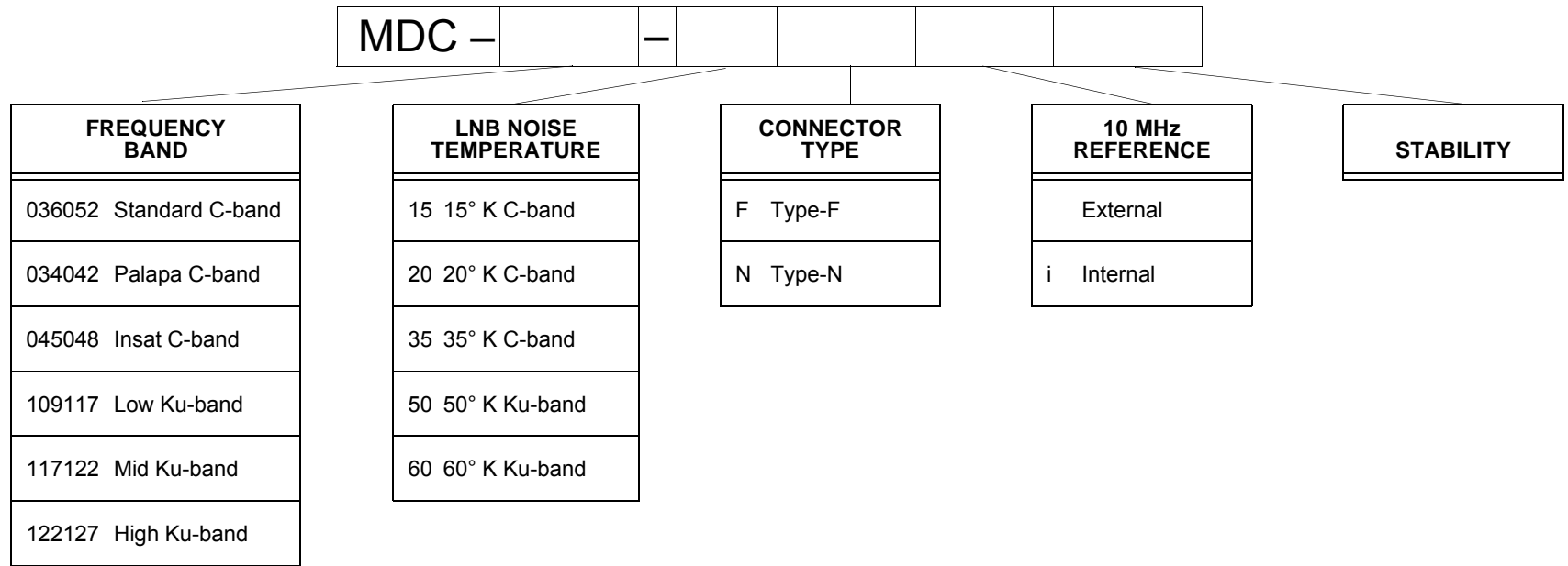

Figure A.8 Part Numbering Schema for LNBS

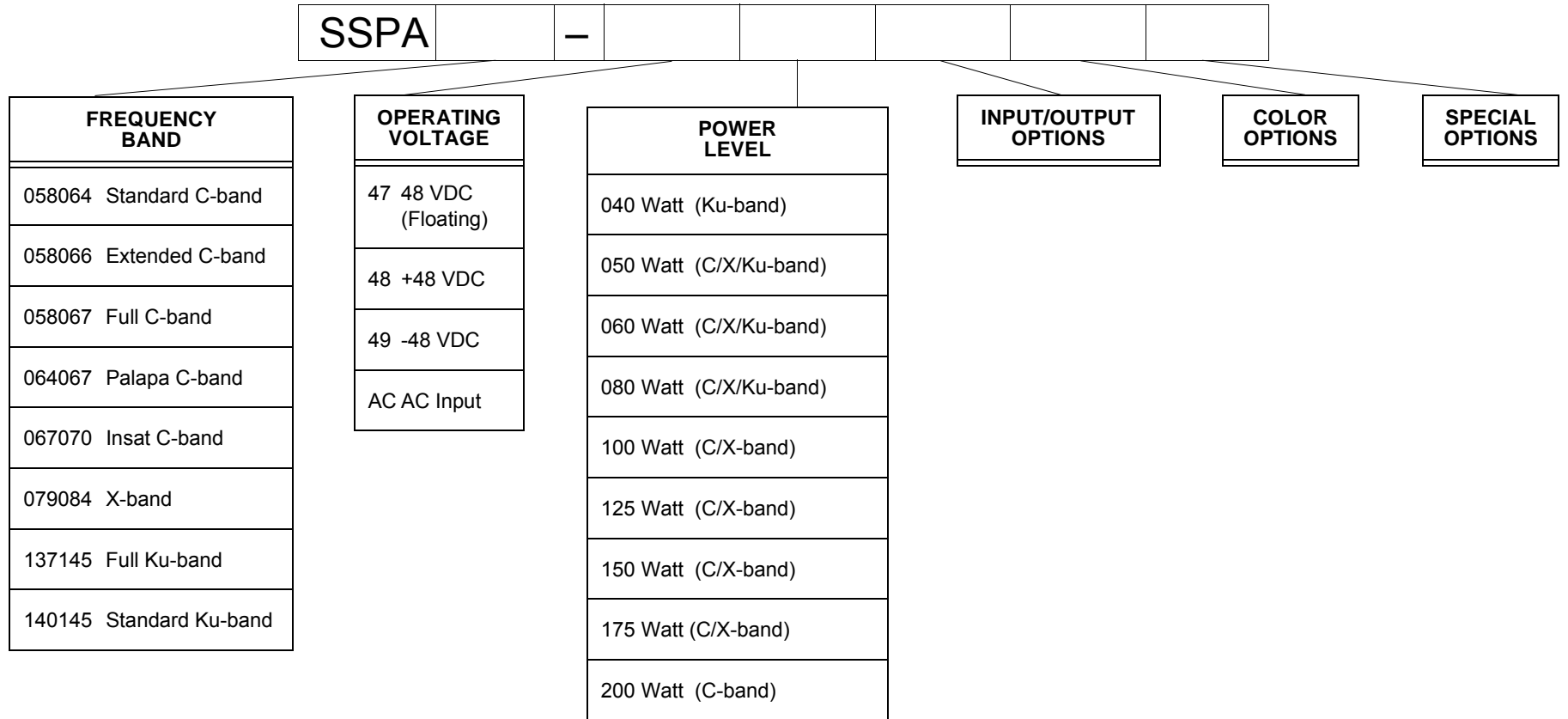

Figure A.9 Part Numbering Schema for SSPAs

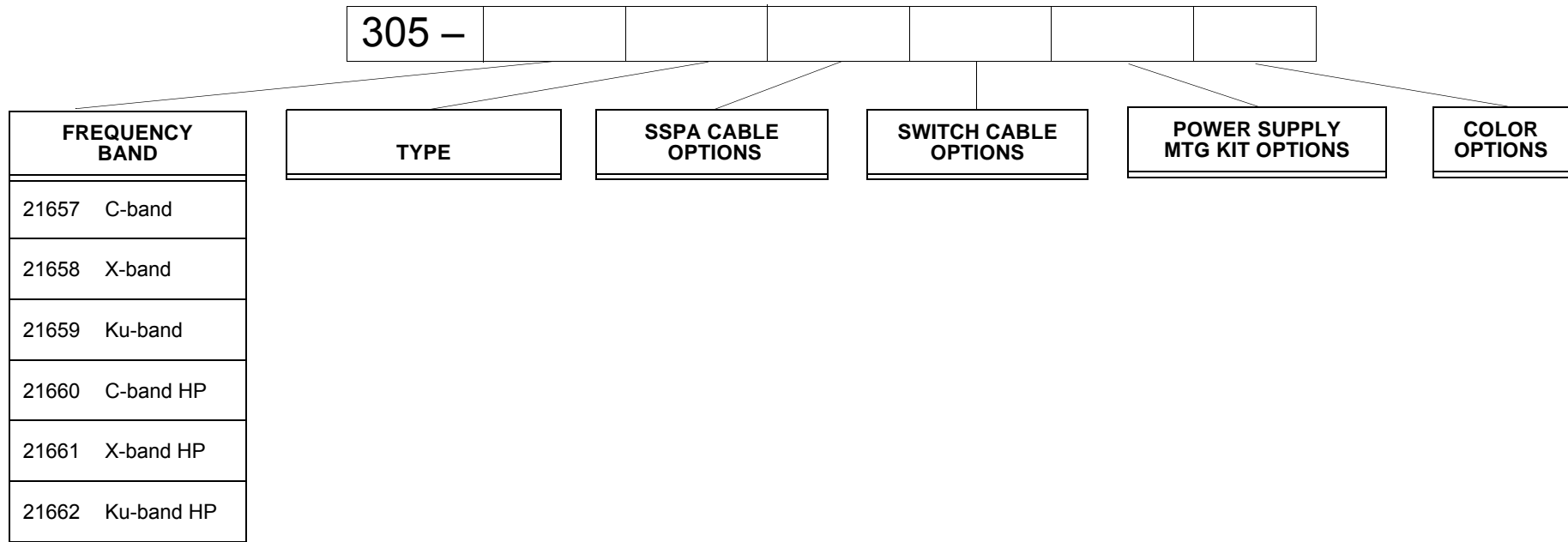

Figure A.10 Part Numbering Schema for Redundant SSPA 1+1 Systems

B

USING HYPERTERMINAL

This appendix describes how to use an RS232 connection and HyperTerminal to communicate with the IBUC.

Establishing a HyperTerminal Session

To communicate with the IBUC using an RS232 connection and HyperTerminal,

1. Connect a cable to a serial port of a PC and the M&C connector of the IBUC. Refer to the fabrication drawing (FBD-210121A.pdf) in [Figure G.1](#) on [page G-2](#) for information about making a 19-in to DB9F cable.
2. From the Windows Start menu, choose Start → All Programs → Accessories → Communications → HyperTerminal.
A HyperTerminal window with a New Connection Description window appears, as shown in [Figure B.1](#). By following the prompts, you can establish the settings for your session and then save them for future use.

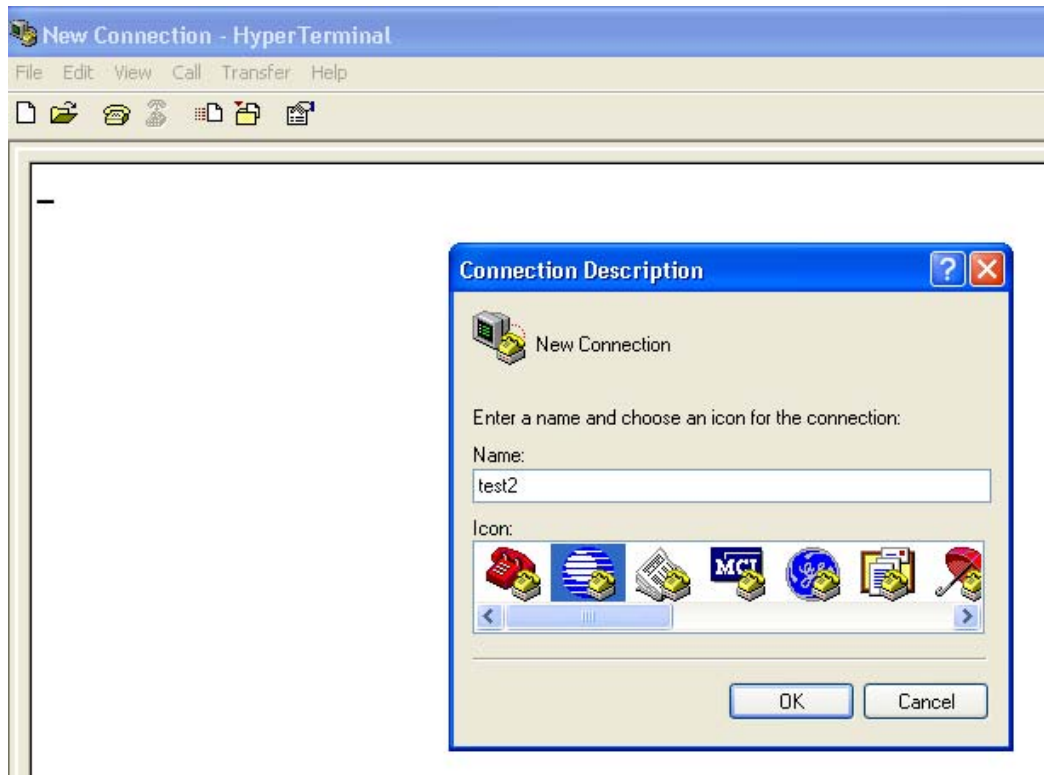

Figure B.1 New Connection Description Window

3. Type a name for the connection and click an icon to select it, and then click OK. In this example, the connection is named “test2”.

4. The Connect To dialog box appears. See [Figure B.2](#).

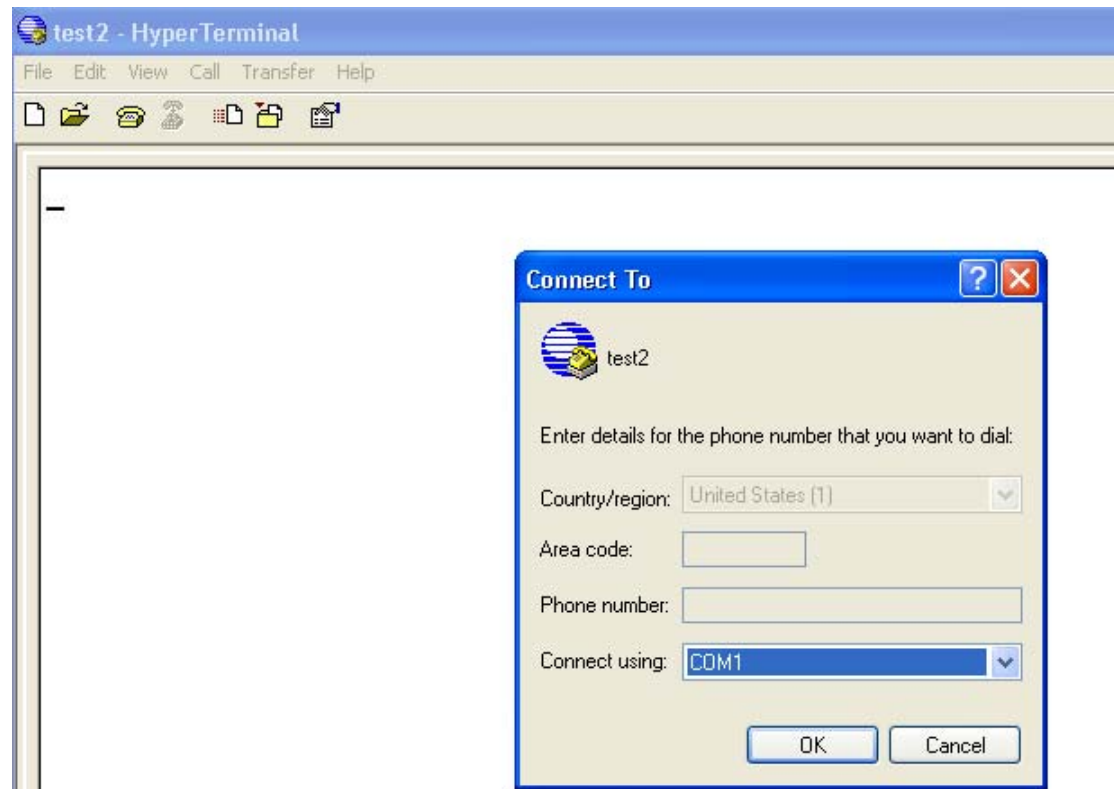

Figure B.2 Connect To Window

5. From the Connect Using drop-down menu, choose the COM port where RS232 is connected (in this example, it is COM1), and then click OK.
The COM1 Properties Window shown in [Figure B.3](#) appears.

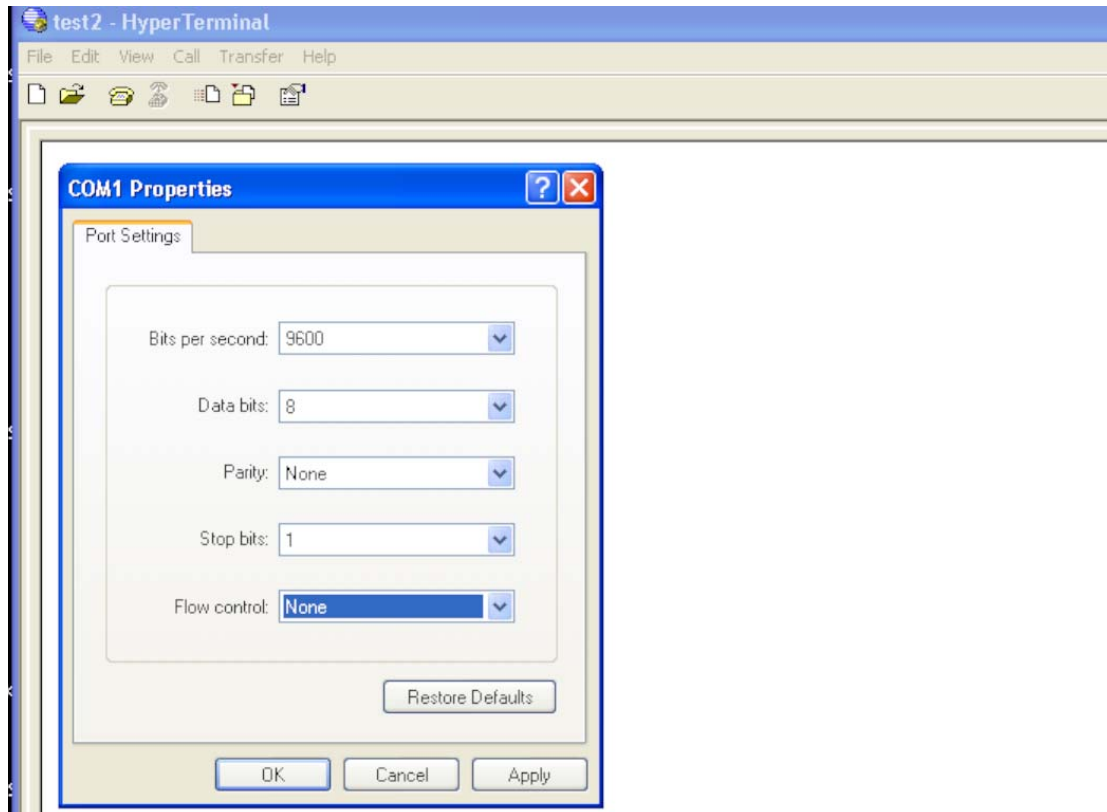

Figure B.3 COM1 Properties Window

6. In the Port Settings dialog box, choose the following options
 - Bits per second: 9600
 - Data bits: 8
 - Parity: None
 - Stop bits: 1
 - Flow control: None
7. Click Apply, and then click OK to save the settings.
8. In the HyperTerminal window, a blinking cursor indicates that the session is now active.
Test the connection by pressing Enter. You should receive an “error=Please enter valid password” message and the IBUC> prompt as shown in [Figure B.4](#).

Note: The format of the responses will vary according to whether the message response mode is set to verbose (the default) or terse. The figures in this document show verbose mode (indicated by the IBUC> prompt). In verbose mode, the output is formatted for easier viewing. To change to terse mode, type C4V=0 at the command line. To return to verbose mode, type C4V=1 at the command line.

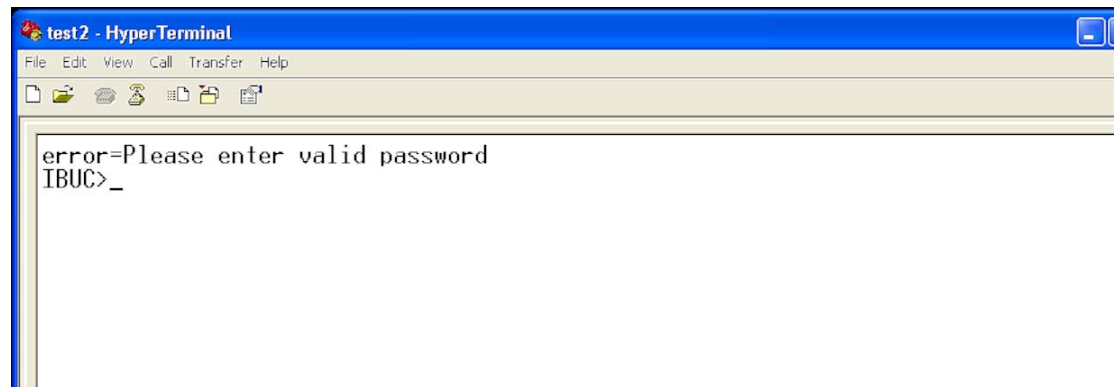

Figure B.4 Invalid Password Error Message

9. From the menu bar, choose File → Properties → Settings. Click on the Settings tab, and then click ASCII Setup. See [Figure B.5](#).

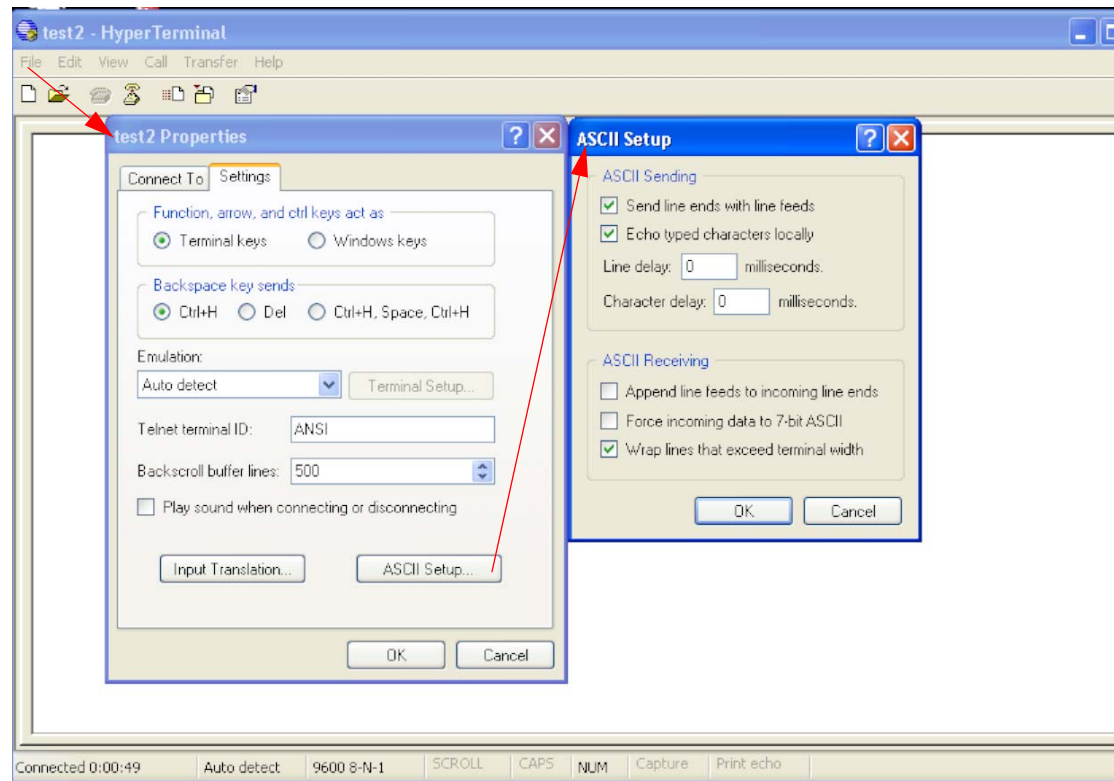

Figure B.5 ASCII Setup Window

10. In the ASCII Setup window, select the following options:
 - ASCII Sending
 - Send line ends with line feeds
 - Echo typed character locally

- ASCII Receiving
 - Wrap lines that exceed terminal width
11. Click OK to save the settings and to close the ASCII Setup dialog box.
 12. Click OK to save the new Properties.
The properties window closes and there is a blank HyperTerminal window with a blinking cursor.
 13. At the IBUC> prompt, type CPE=1234 and press Enter. This command logs you in to the IBUC.
If you have changed the password from the default 1234, type that password instead.
 14. Your login was successful if you receive a blinking prompt in the HyperTerminal window. If you receive an “Error=invalid value” message such as the one in [Figure B.6](#), your login was not successful. Check the password value and try again.

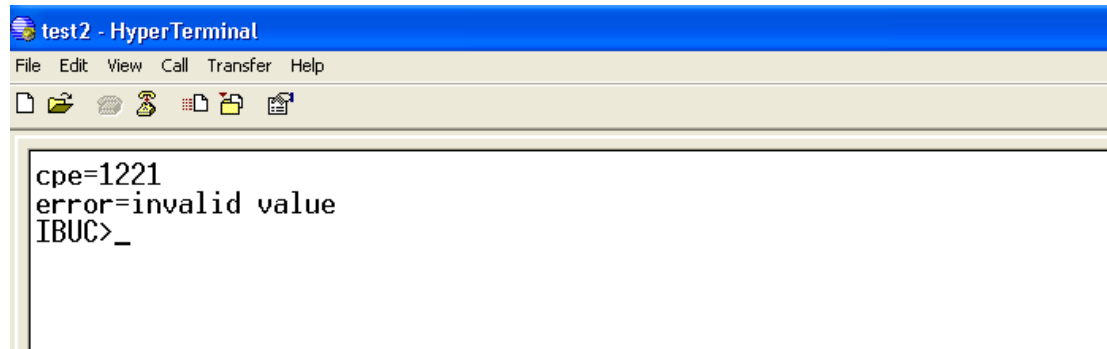
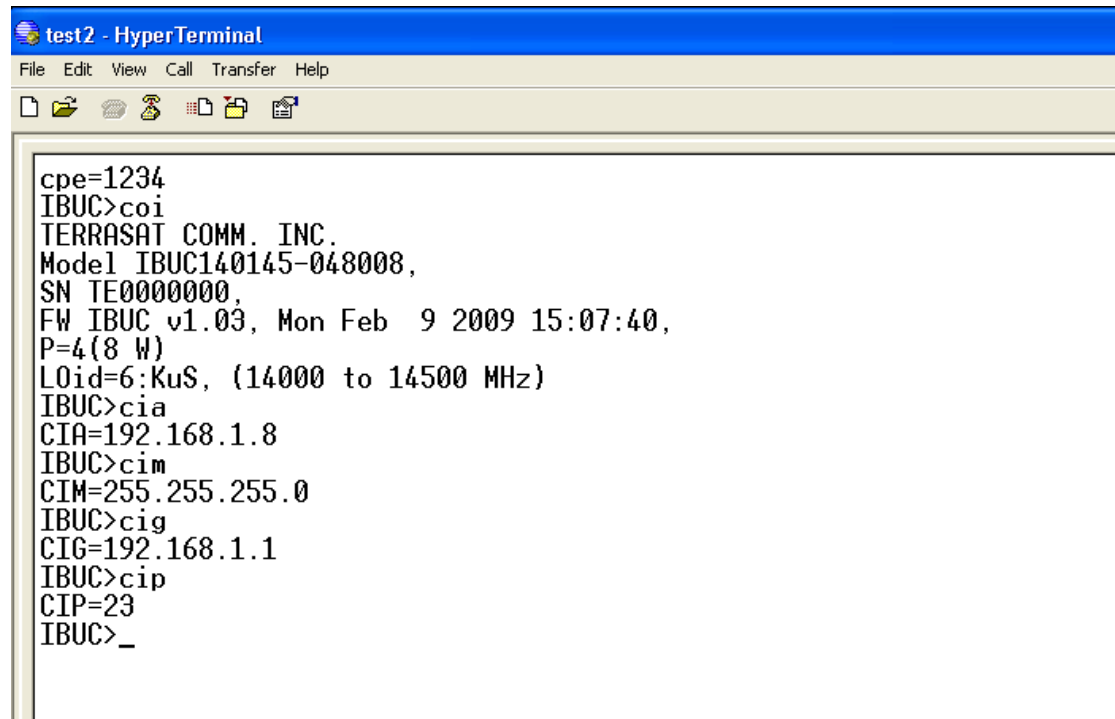

Figure B.6 Invalid Value Error Message

15. The IBUC is now ready to accept commands. An example session begins with [Step 16](#).
 16. Type COI and then press Enter.
This command displays general information about the IBUC such as the serial number and firmware version level.
 17. Type CIA and then press Enter.
This command displays the IP address of the unit.
 18. Type CIM and then press Enter.
This command displays the IP netmask.
 19. Type CIG and then press Enter.
This command displays the IP Gateway address of the unit.
 20. Type CIP and then press Enter.
This command displays the TCP port used for Telnet communications.
- Your screen should resemble the one shown in [Figure B.7](#).



```

test2 - HyperTerminal
File Edit View Call Transfer Help

cpe=1234
IBUC>coi
TERRASAT COMM. INC.
Model IBUC140145-048008,
SN TE00000000,
FW IBUC v1.03, Mon Feb 9 2009 15:07:40,
P=4(8 W)
LOid=6:KuS, (14000 to 14500 MHz)
IBUC>cia
CIA=192.168.1.8
IBUC>cim
CIM=255.255.255.0
IBUC>cig
CIG=192.168.1.1
IBUC>cip
CIP=23
IBUC>_

```

Figure B.7 Active HyperTerminal Window

21. To end the HyperTerminal session, choose File → Exit.
The system will prompt you to confirm that you want to end the session. If this is correct, click Yes. If not, click NO.
22. If you clicked Yes to end the session, the system will prompt you about saving the session settings you input beginning with [Step 3](#). Click Yes to save the named connection.

The HyperTerminal session is now complete.

Using a Saved Connection

To begin a new HyperTerminal session using a named connection,

1. From the Windows Start menu, choose Start → All Programs → Accessories → Communications → HyperTerminal.
A blank New Connection window with a Connection Description window (similar to [Figure B.1](#) on page B-2) appears.
2. Click Cancel when prompted to type a name and to choose an icon for the connection.
3. From the menu bar, choose File → Open.
A list of previously saved HyperTerminal names appears.
4. Click the connection name you want to use, and then click Open.
A blank HyperTerminal window with the previously saved settings appears.

5. Type `CPE=1234` to log into the IBUC.

(Note: If the password has been changed, use that value instead of the default 1234.)

You can now enter ASCII commands at the prompt.

Note: When you create a named connection and then save it, that connection name will also appear as an option when you choose `Start → All Programs → Accessories → Communications → HyperTerminal → <Named Connection>`. Click the name to access your saved connection settings.

Ending a HyperTerminal Session

To end the HyperTerminal session,

- Choose `File → Exit`.

C

ASCII COMMAND/RESPONSE STRUCTURE

Command Set

This command set is used with Telnet and RS232. The command set is used with RS485 and FSK only when C4M=0.

Note: All commands and responses are terminated by using <LF><CR>, where

<LF> indicates line feed (0x0A)

<CR> indicates carriage return (0x0D)

Command responses shown are for Terse mode (when C4V=0).

[Table C.1](#) shows the alarm mask that is used with the following commands:

- AHI
- CAS
- CM1
- CM2
- CMS

Table C.1 Alarm Mask

| Transmit Alarm Mask | |
|---------------------|----------------------------------|
| 0x0001 | AGC/ALC Out of Range Alarm |
| 0x0002 | AGC/ALC Not settled Alarm |
| 0x0004 | DRO Loss of Lock Alarm |
| 0x0008 | Tx Output Threshold High Alarm * |
| 0x0010 | Tx Output Threshold Low Alarm * |

Table C.1 Alarm Mask (Continued)

| Transmit Alarm Mask | |
|----------------------------|--|
| 0x0020 | Tx Input Threshold High Alarm * |
| 0x0040 | Tx Input Threshold Low Alarm * |
| 0x0080 | High Temperature Alarm * |
| 0x0100 | Tx Simulated Alarm |
| 0x0200 | 10 MHz Reference Alarm |
| 0x0400 | Supply Voltage Out of Range Alarm |
| 0x0800 | Waveguide Switch Fault (Tx 1+1 operation only) |
| 0x1000 | Not Used |
| 0x2000 | Supply Current Out of Range Alarm |
| 0x4000 | AGC/ALC Target Out of Range Alarm |
| 0x8000 | Not Used |

*These represent the valid mask for configuring alarms using the CM1, CM2, and CMS commands.

[Table C.2](#) lists possible transmit and miscellaneous alarm flags. Miscellaneous alarms do not involve the actual transmission of data. Instead, they are primarily informational.

Table C.2 Alarm Flags

| Transmit Flags | |
|-----------------------|--|
| 0x0001 | AGC/ALC Out of Range Alarm |
| 0x0002 | AGC/ALC Not settled Alarm |
| 0x0004 | IBUC Loss of Lock Alarm |
| 0x0008 | Tx Output Threshold High Alarm |
| 0x0010 | Tx Output Threshold Low Alarm |
| 0x0020 | Tx Input Threshold High Alarm |
| 0x0040 | Tx Input Threshold Low Alarm |
| 0x0080 | High Temperature Alarm |
| 0x0100 | Tx Simulated Alarm |
| 0x0200 | 10 MHz Reference Alarm |
| 0x0400 | VDC (Supply Voltage) Out of Range Alarm |
| 0x0800 | Waveguide Switch Fault (Tx 1+1 operation only) |
| 0x1000 | Not Used |
| 0x2000 | IDC (Supply Current) Out of Range Alarm |
| 0x4000 | AGC/ALC Target Out of Range Alarm |
| 0x8000 | Not Used |

Table C.2 Alarm Flags (Continued)

| Miscellaneous Flags | |
|---------------------|--|
| 0x0001 | Error-log Pointers Corrupted ¹ |
| 0x0002 | Fault in Restoring Configuration Data ¹ |
| 0x0004 | Ethernet Download Alarm ¹ |
| 0x0008 | Serial Download Alarm ¹ |
| 0x0010 | Reboot Alarm ¹ |
| 0x0020 | Clone Communications Error ² |
| 0x0040 | Clone Read Fault ² |
| 0x0080 | Clone Write Fault ² |

- ¹ These alarms can be classified as transient alarms because, when they are triggered, they will not cause the LED to turn red nor will that alarm appear in the alarm log of the CAS command as a current alarm. It will, however, appear in the alarm log of the AHI command.
- ² These alarms can be classified as persistent alarms because they appear as current alarms in the alarm log of the CAS command and they do cause the LED to become flashing red indicating the status of the alarm. The alarm persists until action is taken to clear the condition causing the alarm.

[Table C.3](#) lists the possible error responses when using RS485, RS232, FSK, and Telnet.

Table C.3 Error Response Table

| Code | Error Message | Description |
|------|--|---|
| 1 | error = invalid value | This is not a valid value for this command. |
| 2 | error = bad command | This command is not in the command set. |
| 3 | error = func not yet done | This command has not been implemented. |
| 4 | error = bad format in command | One of the parameters is formatted incorrectly. |
| 5 | error = error accessing config storage | Unable to access EEPROM. |
| 6 | error = ODU fault | Cannot switch, target unit has a major fault. |
| 7 | error = Please enter valid password | Incorrect password has been entered. |
| 8 | error = Switch Fault | The waveguide switch is faulted. |
| 9 | error = ODU Comm Fault | Legacy Binary packet checksum is invalid. |
| 10 | error = Timeout waiting for packet | UDP has timed out waiting for response packet. |
| 11 | error = Not master | The slave cannot perform the requested command. |
| 12 | error = Turn on Tx first | Cannot engage AGC/ALC because Tx Output is muted. |
| 13 | error = Tx Alarms present | Cannot engage AGC/ALC because DRO is out of lock. |

Table C.3 Error Response Table (Continued)

| Code | Error Message | Description |
|------|---------------------------------|--|
| 14 | error = Burst Not Detected | AGC/ALC time out waiting for a valid burst (15 seconds). |
| 15 | error = AGC/ALC Targets OOR | The ALC target power is outside the valid power range of the unit. The AGC target gain is outside the range of the unit. |
| 16 | error = Gain Control OOR | When engaging AGC/ALC mode, the gain control is outside preset limits. |
| 17 | error = Redund not enabled | This unit is not part of a redundant pair. |
| 18 | error = Invalid IP for subnet | The IP subnet selected is invalid for the configured IP address. |
| 19 | SET is not valid with <command> | You can only query this parameter. |
| 20 | GET is not valid with <command> | You can only change this parameter. |

Common Commands

Commands in this section can be used with transmit and receive systems.

AHI

Description: Displays the contents of the alarm log. The alarm log holds a maximum of 40 events and events can contain multiple alarms. This is a read-only command.

Error Responses: 7, 19

Response Values:

Event log is empty
 AHI=<alarm string>, <alarm string>,...

AHZ

Description: Clears the alarm log.

Error Responses: 7, 19

Response Values:

AHZ=event log cleared

C10

Description: Displays the state of the 10 MHz detector. This is a read-only command.

Error Responses: 7, 19

Response Values:

C10=<Parameter>

Parameter:

0 – 10 MHz is too low

1 – 10 MHz is within range

C4A

Description: Displays or sets the RS485/FSK address. If the address is changed, both the RS485 and the FSK communication links are affected. The new address is then used for the response.

Error Responses: 1, 7

Default Value = 1

Command/Response Values:

C4A=<Parameter>

Parameter:

1–15 if C4M=1

1–254 if C4M=0

C4D

Description: Displays or sets the delay in milliseconds before a response is returned on the RS485 and FSK link.

Error Responses: 1, 7

Default Value = 20

Command/Response Values:

C4D=<Parameter>

Parameter:

1–255

C4R

Description: Displays or sets the RS485 baud rate. This does not affect the FSK link because that is fixed at 9600 baud.

Error Responses: 1, 7

Default Value = 9600

Command/Response Values:

C4R=<Parameter>

Parameter:

1200, 2400, 4800, 9600, 19200, 38400, 57600, or 115200

C4V

Description: Displays or sets the message response mode. Terse mode is used for computers where the response items are separated by commas and the message is terminated with <LF><CR>. Verbose is better suited for use with terminal emulation programs such as Telnet or HyperTerminal. Output is formatted for easier viewing by the user. This is a global command affecting all interfaces operating in ASCII mode.

Error Responses: 1, 7

Default Value = 1

Command/Response Values:

C4V=<Parameter>

Parameter:

0 – Terse

1 – Verbose

CAS

Description: Displays the current active alarms. Use the CAS command to display hexadecimal values that represent the Transmit and Miscellaneous alarms. See [Table C.1](#) on [page C-1](#) for the meaning of the individual alarms or use CAS=1 to display the alarm strings.

Error Responses: 1, 7

Response Values:

CAS=T:0x0010, M:0x0010 Tx Only

CAS=R:0x0010, M:0x0010 Rx Only

CCM

Description: Displays the model number and serial number of the IBUC. This is a read-only command.

Error Responses: 1, 7, 19

Response Values:

CCM=<Model number>, <Serial number>

where

Model number is a variable string of up to 20 characters

Serial number is a variable string of up to 10 characters

CCS

Description: Displays the M&C firmware version level. This is a read-only command.

Error Responses: 1, 7, 19

Command/Response Values:

CCS=<Firmware revision string>

where

Firmware revision is a variable string of characters.

CIA

Description: Displays or sets the IP address of the unit. Valid values range from (but do not include) 1.0.0.0 through 224.0.0.0. When the netmask is applied, 0 and 255 in the last byte are excluded.

Error Responses: 1, 4, 7, 18

Default Value =192.168.1.21 Tx
192.168.1.254Rx

Command/Response Values:

CIA=<Dotted Decimal IP Address>

CIC

Description: Sets the SNMP community string.

Error Responses: 1, 2, 4, 5, 7

Default: public, private, trap

Command/Response Values:

CIC= public, private, trap

CID

Description: Displays the current consumption. This is a read-only command.

Error Responses: 1, 20

Response Values:

CID=<Parameter>

Parameter:

0.0–25.0 Amperes

CIG

Description: Displays or sets the IP Gateway address. This address cannot be the same as the IP address of the unit. This is the address the unit will send to if the requested IP address does not reside on the local LAN segment.

Error Responses: 1, 4, 7

Default Value = 192.168.1.1

Command/Response Values:

CIG=<DOTTED DECIMAL IP ADDRESS>

CIM

Description: Displays or sets the IP netmask. Valid values range from 8 through 30 representing the number of ones in the netmask. This corresponds to 255.0.0.0–255.255.255.252.

Error Responses: 1, 2, 7, 18

Default Value = 255.255.255.0

Command/Response Values:

CIM=<netmask>

CIP

Description: Displays or sets the TCP port used for Telnet communication.

Error Responses: 1, 4, 7

Default Value = 23

Command/Response Values:

CIP=<Port>

Port:

1–65535

CIS

Description: Displays or sets the SNMPv1 enable state. When enabled, the unit will respond to SNMPv1 requests.

Error Responses: 1, 4, 7

Default Value = 1

Command/Response Values:

CIS=<Parameter>

Parameter:

0 – Disable SNMPv1

1 – Enable SNMPv1

CIT

Description: Displays or sets the generation of SNMPv1 traps.

Error Responses: 1, 4, 7

Default Value = 1

Command/Response Values:

CIT=<Parameter>

Parameter:

0 – Disable Traps

1 – Enable Traps

CM1

Description: Displays or sets the minor alarm mask of the unit. This is a hexadecimal value.

Error Responses: 1, 4, 7

Default Value = 0x00E0

Command/Response Values:

CM1=<Hex Value>

Hex Value:

See [Table C.1](#) on [page C-1](#) for available hexadecimal values.

CM2

Description: Displays or sets the major alarm mask of the unit. This is a hexadecimal value.

Error Responses: 1, 4, 7

Default Value = 0x0018

Command/Response Values:

CM2=<Hex Value>

Hex Value:

See [Table C.1](#) on [page C-1](#) for available hexadecimal values.

CMS

Description: Displays or sets the alarm suppression mask of the unit. This is a hexadecimal value.

Error Responses: 1, 4, 7

Default Value = 0x0078

Command/Response Values:

CMS=<Hex Value>

Hex Value:

See [Table C.1](#) on [page C-1](#) for available hexadecimal values.

COI

Description: Displays general information about the unit. This is a read-only command.

Error Responses: 1, 7

CPE

Description: Logs the user into the unit. You cannot query this item.

Error Responses: 1, 7, 20

Command Values:

CPE=<Value>

Value:

1-65535

CPL

Description: Displays the private label string of the unit.

Error Responses: 1, 7, 20

Response Values:

CPL=<Value>

Value:

Variable string up to 20 characters

CPS

Description: Sets the password for logging into the unit. The password does not take effect until the next login. You cannot query this item.

Error Responses: 1, 7, 20

Default Value: 1234

Command Values:

CPS=<Value>

Value:

1-65535

CPT

Description: Displays or sets the login timeout. After the configured time period elapses with no user interaction, the session is dropped (ends).

Error Responses: 1, 7

Default Value = 0

Command/Response Values:

CPT=<Value>

Value:

0 – No timeout

1–65535 minutes

CRT

Description: Displays or sets the frequency trimming value of the internal 10 MHz reference signal.

Error Responses: 1, 7

Command/Response Values:

CRT=<Value>

Parameter:

0 – 255

CTM

Description: Displays or sets the system time.

Error Responses: 1, 2, 4, 7

Default Value: random default value

Command Values:

CTM=<mm/dd/yyyy hh:mm:ss

CVD

Description: Displays the current power supply voltage. This is a read-only command.

Error Responses: 1, 7, 20

Response Values:

CVD=<Value> Tx
CVD=<Value>,<Value> Rx

Value:

0.0–60.0 Volts DC

CWR

Description: Displays or sets the rate at which the Web page automatically refreshes.

Error Responses: 1,7

Default Value = 0

Command/Response Values:

CWR=<Seconds>

Seconds:

0 – No refresh

1–3600 second

CZZ

Description: Reboots the M&C firmware and resets all parameters to their default values.

Error Responses: 1, 7

Command/Response Values:

CZZ

CZZ=1

Parameter:

1 – Resets only int_values and reboots

Note: This will cause a momentary mute of the transmitter, and should be used with caution.

DCN

Description: Disconnects the current Telnet session.

Error Responses: None

Command Values: No response

EKO

Description: Displays or sets whether the unit responds to commands. If EKO is disabled, you will receive no response to commands. However, responses are always returned to queries. This does not affect characters being echoed to the terminal during Telnet sessions.

Error Responses: 1, 7

Default Value = 1

Command/Response Values:

EKO=<Parameter>

Parameter:

0 – No command response

1 – Respond to commands

Receive-only Commands

This section contains information about various commands used only for reception

CTD

Description: Displays or sets the 10 MHz reference alarm enable state.

Error Responses: 1, 2, 4, 5, 7

Command/Response Values:

CTD=<Parameter>

Parameter:

0 – Disable

1 – Enable

IAH

Description: Displays or sets the current alarm high threshold for the A: side.

Error Responses: 1, 7

Default Value = 500

Command/Response Values:

IAH=<Parameter>

Parameter:

100 – 600 ma (must be greater than the low threshold)

IAL

Description: Displays or sets the current alarm low threshold for the A: side.

Error Responses: 1, 7

Default Value = 250

Command/Response Values:

IAL=<Parameter>

Parameter:

100 – 600 ma (must be less than the high threshold)

IBH

Description: Displays or sets the current alarm high threshold for the B: side.

Error Responses: 1, 7

Default Value = 500

Command/Response Values:

IBH=<Parameter>

Parameter:

100 – 600 ma (must be greater than the low threshold)

IBL

Description: Displays or sets the current alarm low threshold for the B: side.

Error Responses: 1, 7

Default Value = 1

Command/Response Values:

IBL=<Parameter>

Parameter:

100 – 600 ma (must be less than the high threshold)

RAL

Description: Displays or sets the input low power level threshold for the A: side.

Error Responses: 1, 7

Default Value = -40.0

Command/Response Values:

RAL=<Parameter>

Parameter:

5.0 dBm to -40.0 dBm (in 0.1 dBm steps)

RAS

Description: Displays or sets the receive alarm simulation for the A: side unit. Places alarm relay into “faulted” state and sets bit in alarm byte.

Error Responses: 1, 7

Default Value = 0

Command/Response Values:

RAS=<Parameter>

Parameter:

0 – Off

1 – On

RAZ

Description: Displays or sets receive alarm suppression for the A: side unit. If suppression is enabled, any alarms configured for suppression by using the CMS command will not cause a major alarm.

Error Responses: 1, 7

Default Value = 0

Command/Response Values:

RAZ=<Parameter>

Parameter:

0 – Off

1 – On

RBL

Description: Displays or sets input low power level threshold for the B: side unit .

Error Responses: 1, 7

Default Value = 0

Command/Response Values:

RBL=<Parameter>

Parameter:

5.0 dBm to –40.0 dBm (in 0.1 dBm steps)

RBS

Description: Displays or sets the receive alarm simulation for the B: side unit. Places alarm relay into "faulted" state and sets bit in alarm Byte.

Error Responses: 1, 7

Default Value = 0

Command/Response Values:

RBS=<Parameter>

Parameter:

0 – Off

1 – On

RBZ

Description: Displays or sets receive alarm suppression for the B: side unit. If suppression is enabled, any alarms configured for suppression by using the CMS command will not cause a major alarm.

Error Responses: 1, 7

Default Value = 0

Command/Response Values:

RBZ=<Parameter>

Parameter:

0 – Off

1 – On

RDT

Description: Displays the current input power level in dBm. This is a read-only command.

Error Responses: 1, 7

Command/Response Values:

RDT=<Parameter>,<Parameter>

Parameter:

VAH

Description: Displays or sets the high voltage threshold for the A: side.

Error Responses: 1, 7

Default Value = 24

Command/Response Values:

VAH=<Parameter>

Parameter:

10.0 to 25.0 VDC (Must be greater than the low threshold)

VAL

Description: Displays or sets the low voltage threshold for the A: side.

Error Responses: 1, 7

Default Value = 15

Command/Response Values:

VAL=<Parameter>

Parameter:

10.0 to 25.0 VDC (Must be less than High Threshold)

VBH

Description: Displays or sets the low voltage threshold for the B: side.

Error Responses: 1, 7

Default Value = 1

Command/Response Values:

VBH=<Parameter>

Parameter:

10.0 to 25.0 VDC (Must be greater than the low threshold)

VBL

Description: Displays or sets the low voltage threshold for the B: side.

Error Responses: 1, 7

Default Value = 1

Command/Response Values:

VBL=<Parameter>

Parameter:

10.0 to 25.0 VDC (Must be less than High Threshold)

Transmit-only Commands

This section contains information about various commands used only for transmission.

ATL

Description: Displays the temperature log for the IBUC. This is a read-only command.

Error Responses: 7, 19

Response Values:

ATL=<minimum temperature>, <minimum temperature>, <entries>

C4M

Description: Displays or sets the RS485 or FSK messaging protocol.

Error Responses: 1, 7

Command/Response Values:

C4M=<Parameter>

Parameter:

0 – ASCII

1 – Legacy Binary

For more information, see [Appendix D, Legacy Binary Command Message Structure](#).

CIB

Description: Displays or sets the IP address of the other IBUC in a redundant (Tx 1+1) pair. The A: side IBUC should have the IP address of the B: side IBUC entered here. The B: side IBUC should have the IP address of the A: side IBUC entered here. This enables the IBUC to identify its partner in a redundant pair for communication purposes.

Example:

| A: Side | B: Side |
|-------------------|-------------------|
| CIA=192.168.1.200 | CIA=192.168.1.201 |
| CIB=192.168.1.201 | CIB=192.168.1.200 |

Default Value = 192.168.1.22

Error Responses: 1, 4, 7

Command/Response Values:

CIB=<DOTTED DECIMAL IP ADDRESS>

CLE

Description: Displays or sets the state of the external LED indicator. If disabled, the external LED indicator will remain off.

Error Responses: 1, 4, 7

Default Value = 1

Command/Response Values:

CLE=<Parameter>

Parameter:

0 – Disabled

1 – Enabled

COX

Description: Displays the current internal temperature of the unit.

Error Responses: 1, 7

Command/Response Values:

COX=<Parameter>

Parameter:

-50 to +100

CSF

Description: Displays or sets a scaling factor. When enabled, this command applies a 50 Hz correction to AC-powered units. This command is not available to DC-powered units.

Error Responses: 1, 7

Default Value = 0

Command/Response Values:

CSF=<Parameter>

Parameter:

0 – Disabled

1 – Enabled

CTV

Description: Displays the DRO tuning voltage. This is a read-only command.

Error Responses: 1, 7, 20

Response Values:

CTV=<Value>

HLP

Description: Displays the command list with short help strings.

TAH

Description: Displays or sets the output high power threshold. This item must be greater than the TAL setting.

Error Responses: 1, 7

Default Value = Based upon IBUC power level. See [Table C.4](#) on [page C-32](#).

Command/Response Values:

TAH=<Parameter>

Parameter:

Between rated power and no less than 20 dBm below rated power

TAL

Description: Displays or sets the output low power threshold. This setting must be less than the TAH setting.

Error Responses: 1, 7

Default Value = Based upon IBUC power level. See [Table C.4](#) on [page C-32](#).

Command/Response Values:

TAL=<Parameter>

Parameter:

Between rated power and no less than 20 dBm below rated power

TAS

Description: Displays or sets the Tx simulated alarm setting.

Error Responses: 1, 7

Default Value = 0

Command/Response Values:

TAS=<Parameter>

Parameter:

0 – No alarm

1 – Simulate a Tx alarm

TAZ

Description: Displays or sets the alarm suppression setting of the IBUC. If suppression is enabled, any alarms configured for suppression by using the CMS command will not cause a major alarm.

Error Responses: 1, 7

Default Value = 0

Command/Response Values:

TAZ=<Parameter>

Parameter:

0 – No suppression

1 – Suppress configurable alarms

TBH

Description: Displays or sets the input high power threshold. It must be greater than TBL.

Error Responses: 1, 7

Default Value = -15

Command/Response Values:

TBH=<Parameter>

Parameter:

-15.0 to -60.0

TBL

Description: Displays or sets the input low power threshold. It must be less than TBH.

Error Responses: 1, 7

Default Value = -60

Command/Response Values:

TBL=<Parameter>

Parameter:

-15.0 to -60.0

TBN

Description: Displays or sets the burst count of the IBUC. The burst count determines the number of samples to average to compute current output and input power. Once a burst is received, the IBUC will collect output power level data every 125 μ s. Once 16 samples are collected, they are sorted from highest to lowest value, and the highest burst count samples are averaged to determine the current power reading.

Error Responses: 1, 7

Default Value = 8

Command/Response Values:

TBN=<Parameter>

Parameter:

1–16

Note: This command is applicable only to firmware revision 1.00 and below.

TBT

Description: Displays or sets the burst threshold for the IBUC. This value determines the level at which a burst is considered valid.

Error Responses: 1, 7

Default Value = Based upon IBUC power level. See [Table C.4](#).

Command/Response Values:

TBT=<Parameter>

Parameter:

Between rated power and no less than 20 dBm below rated power

Table C.4 Default Values for the TAH, TAL, and TBT Commands

| Power Level | TAH Default Value | TAL Default Value | TBT Default Value |
|-------------|-------------------|-------------------|-------------------|
| 002 | 34.0 | 13.0 | 13.0 |
| 004 | 37.0 | 16.0 | 16.0 |
| 005 | 38.0 | 17.0 | 17.0 |
| 008 | 40.0 | 19.0 | 19.0 |
| 010 | 41.0 | 20.0 | 20.0 |
| 012 | 41.8 | 21.0 | 21.0 |
| 016 | 43.0 | 22.0 | 22.0 |
| 020 | 44.0 | 23.0 | 23.0 |
| 025 | 45.0 | 24.0 | 24.0 |
| 030 | 45.8 | 25.0 | 25.0 |
| 040 | 47.0 | 26.0 | 26.0 |
| 050 | 48.0 | 27.0 | 27.0 |
| 060 | 48.8 | 28.0 | 28.0 |
| 080 | 50.0 | 29.0 | 29.0 |
| 100 | 51.0 | 30.0 | 30.0 |
| 125 | 52.0 | 31.0 | 31.0 |
| 150 | 52.8 | 32.0 | 32.0 |
| 175 | 53.4 | 32.4 | 32.4 |
| 200 | 54.0 | 33.0 | 33.0 |

TDT

Description: Displays the current input power reading. This is a read-only command.

Error Responses: 7, 19

Command/Response Values:

TDT=<Value>

Value:

-15.0 to -60.0

TFB

Description: Displays the RF frequency band of this IBUC. This is a read-only command.

Error Responses: 7, 19

Command/Response Values:

TFB=<Value>

Value:

- 3 – Standard C-band (5850–6425 MHz)
- 4 – Insat C-band (6725–7025 MHz)
- 5 – Extended Ku-band (13750–14250 MHz)
- 6 – Standard Ku-band (14000–14500 MHz)
- 7 – X-band (7900–8400 MHz)
- 8 – Full Ku-band (13750–14500 MHz)
- 9 – Extended C-band (5850–6650 MHz)
- 10 – Full C-band (5850–6725 MHz)
- 11 – Low Ku-band (12750–13250 MHz)
- 12 – Palapa C-band (6425–6725 MHz)
- 14 – DBS-band 1 (17300–18100 MHz)
- 15 – DBS-band 2 (18100–18400 MHz)
- 16 – Ka-band 1 (29500–30000 MHz)
- 17 – Ka-band 2 (30000–31000 MHz)
- 18 – Ku-band 4 (12800–13300 MHz)
- 19 – C-band 6 (5725–6425 MHz)
- 20 – Ka-band 3 (29000–30000 MHz)

TFI

Description: Displays the spectral inversion for this IBUC. This is a read-only command.

Error Responses: 7, 19

Command/Response Values:

TFI=<Value>

Value:

0 – No spectrum inversion

1 – Spectrum is inverted

TFR

Description: Displays or sets the output power monitor frequency of the IBUC.

Error Responses: 1, 7

Command/Response Values:

TFR=<Frequency>

Frequency:

Which IF or RF frequency to monitor is based upon the frequency band of the IBUC. IF will be automatically converted to RF.

The default values in [Table C.5](#) are listed according to the model number of the IBUC.

Table C.5 Default Values for the TFR Command

| Model Number | Default Value |
|--------------|---------------|
| 057064 | 6075 |
| 058064 | 6137 |
| 058066 | 6250 |
| 058067 | 6287 |
| 064067 | 6575 |
| 067070 | 6875 |
| 079084 | 8150 |
| 127132 | 13000 |
| 128133 | 13050 |
| 137142 | 14000 |
| 137145 | 14125 |
| 140145 | 14250 |
| 173181 | 17700 |
| 181184 | 18250 |
| 290300 | 29500 |
| 295300 | 29750 |
| 300310 | 30500 |

TGC

Description: Displays or sets the operating mode of the IBUC. When using AGC or ALC, the IBUC power levels must be set prior to closing the loop.

Error Responses: 1, 7, 12, 13, 14, 15, 16

Default Value = 0

Command/Response Values:

TGC=<Parameter>

Parameter:

0 – Open loop

1 – Automatic Level Control (ALC)

2 – Automatic Gain Control (AGC)

TGL

Description: Displays the gain and level targets for AGC or ALC. This is a read-only command.

Error Responses: 7, 19

Command/Response Values:

TGL=<gain target>, <level target>

TGR

Description: Displays or zeroes the gain control of the IBUC.

Error Responses: 1, 7

Command/Response Values:

TGR=<Parameter>

Parameter:

-8.0 to 8.0 dB

TGR=0 – Zero Gain Control

TPM

Description: Displays or sets the power monitoring mode of the IBUC. When configured for burst, TBT must also be set. Default values for the TBT command are given in [Table C.4](#) on [page C-32](#).

Error Responses: 1, 7

Default Value = 0

Command/Response Values:

TPM=<Parameter>

Parameter:

0 – CSM

1 – Burst

TPO

Description: Displays the current output power of the IBUC. If TPM is set to burst, this will be the last valid burst sample of the output power. Use the TFR command to configure the desired frequency to be monitored. This is a read-only command.

Error Responses: 7, 19

Response Values:

TPO=<Value>

Value:

Between rated power and no less than 20 dBm below rated power

TPT

Description: Displays or sets the attenuator of the IBUC. Changing this value will increase or decrease the output level/gain of the IBUC.

Error Responses: 1, 7

Command/Response Values:

TPT=<Parameter>

Parameter:

0.0–16.0

TSD

Description: Displays or sets the transmit power output delay of the IBUC. When configured, the Tx output will be muted for the time period configured. Once that time period expires, the Tx output will be enabled or disabled based upon the TSP and TST settings. If there are Tx faults, the Tx output will not be enabled.

Error Responses: 1, 7

Default Value = 0

Command/Response Values:

TSD=<Parameter>

Parameter:

0 – No power up delay

1–500 seconds

TSP

Description: Displays or sets the state of the Tx output at power up.

Error Responses: 1, 7

Default Value = 1

Command/Response Values:

TSP=<Parameter>

Parameter:

0 – Tx output OFF

1 – Tx output ON

TST

Description: Displays or sets the state of the Tx output. This command can be overridden by alarms.

Error Responses: 1, 7

Default Value = 1

Command Values:

TST=<Parameter>

Parameter:

0 – Disable Tx output

1 – Enable Tx output

Response Values:

Parameter:

0 – Tx Disabled

1 – Tx Enabled, Not Muted

2 – Tx Enabled, Muted

TTS

Description: Displays or sets the high-temperature shutdown alarm. When enabled, the IBUC will go into alarm mode when the internal temperature reaches 85 °C and the Tx output will be muted.

Error Responses: 1, 7

Default Value = 1

Command/Response Values:

TTS=<Parameter>

Parameter:

0 – No alarm

1 – Alarm

Redundancy Commands

This section contains information about various redundancy commands. The commands are applicable to Tx 1+1 and Rx 1+1 systems, unless noted otherwise. Definitions of error responses are found in [Table C.3](#) on [page C-3](#).

BAE

Note: Applies only to Tx 1+1 systems.

Description: Displays the redundancy configuration of the IBUC. This is a read-only command.

Error Responses: 7, 19

Response Values:

BAE=<Redundancy>

Redundancy:

0 – Redundancy not enabled

1 – Redundancy enabled

Position:

Master Position

Slave Position

Clone:

Clone Enabled

Clone Disabled

BAM

Description: Displays or sets the redundancy switching mode of operation. When configured for reverting, the units can switch between each other when a fault occurs multiple times unless both units are faulted. In non-reverting operation, when the A: side unit faults, a switch to the B: side unit will occur unless the B: side unit has faulted. Once on the B: side unit, no additional switches can occur without user intervention. This item can be changed only from the Online/Master unit.

Error Responses: 1, 7, 17

Default Value = 0

Command/Response Values:

BAM=<Parameter>

Parameter:

0 – Reverting

1 – Nonreverting

BAP

Note: Applies only to Tx 1+1 systems.

Description: Displays or sets the position of the IBUC on the waveguide switch. This does not change the position of the waveguide switch, but instead tells the IBUC firmware to which port the Tx output is connected on the waveguide switch. This item must be set for each IBUC in a redundant pair.

Error Responses: 1, 7, 17

Default Value = 0

Command/Response Values:

BAP=<Parameter>

Parameter:

0 – A: side

1 – B: side

BCL

Note: Applies only to Tx 1+1 systems.

Description: Displays or sets the cloning configuration of a redundant pair. The following commands are always cloned: BAM, BSM, and BCL. They can be changed only from the Online/Master IBUC. All other commands can be individually set with cloning disabled. When enabled, the following commands are automatically sent to the Offline/Slave IBUC on a periodic basis: C4V, C4D, C4M, C4R, CPS, CPT, CM1, CM2, CMS, CWR, EKO, TAH, TAL, TAZ, TBH, TBL, TBN, TBT, TFR, TPM, TSD, TSP, TST, and TTS and can be changed only from the Online/Master IBUC.

Error Responses: 1, 7, 17

Default Value = 1

Command/Response Values:

BCL=<Parameter>

Parameter:

0 – Disable

1 – Enable

BSM

Description: Displays or sets the switching type. When configured for manual switching, you can switch between units at will by using the BSW command regardless of any faults. While in manual mode, the units will not switch due to a fault. When configured for automatic operation, a switch will occur if a major fault occurs on the online unit unless the standby is also faulted. If both units are not faulted, you can switch between the A: side and the B: side by using the BSW command described on [page C-46](#).

Error Responses: 1, 7, 17

Default Value = 1

Command/Response Values:

BSM=<Parameter>

Parameter:

0 – Manual

1 – Automatic

BST

Description: Displays system status for a redundant pair.

Error Responses: 7, 17, 19

Response Values:

BST=<A: mode>, <A: online>, <B: mode>, <B: online>, <Switch>

A: mode/B: mode: Auto or Manual

A: online/B: online: Online or Standby

Switch: A: side or B: side

BSW

Description: Displays or sets the online status of a redundant pair. This command controls which unit is online by physically changing the waveguide switch position.

Error Responses: 1, 7, 8, 17

Command/Response Values:

BSW=<Parameter>

Parameter:

0 – A: side

1 – B: side

D

LEGACY BINARY COMMAND MESSAGE STRUCTURE

Command Set

The command set listed in [Table D.1](#) is used on the RS485 and FSK links only when C4M=1.

Table D.1 IBUC Commands

| Byte | Name | Description | Value |
|------|---------|---|--------------|
| 1 | Address | IBUC address | 0x01 to 0x0F |
| 2 | Command | Request status | 0x01 |
| | | Set Transmit On/Off state | 0x02 |
| | | Change IBUC address or set RS485 response delay | 0x03 |
| | | Set detected carrier frequency | 0x04 |
| | | Set power threshold | 0x05 |
| | | Request burst power level | 0x06 |
| | | Request device type ID | 0x07 |
| | | Request/set temperature log | 0x09 |
| | | Gain Attenuator Adjust | 0xFF |

Table D.1 IBUC Commands (Continued)

| Byte | Name | Description | Value |
|------|---------------------------------|--|--|
| 3 | Data Byte 1 If command= | | |
| | 0x01 | Not used | 0xAA |
| | 0x02 | Tx control | 0=Off 1=On 2=Off @ Pwr On 3=On @ Pwr On |
| | 0x03 | Set new IBUC address | 0x01 to 0x0F |
| | 0x04 | Set detected carrier frequency MSB | MSB |
| | 0x05 | Set Power threshold MSB | MSB |
| | 0x06 | Request "current burst power" selector | 0x00 |
| | | Request "stored min/max burst power" selector 0x01 | |
| | 0x07 | Request "IBUC S/N" selector | 0x00 |
| 4 | Data Byte 2 If command= | | |
| | 0x01 | Not used | 0xAA |
| | 0x02 | Not used | 0xAA |
| | 0x03 | RS485 delay value in ms | 0x01...0xFF |
| | 0x04 | Detected carrier frequency LSB | LSB |
| | 0x05 | Power threshold LSB | LSB |
| | 0xFF | Gain Backoff | 0x01 to 0xF |
| 5 | Data Byte 3 Factory Use Only | 0xAA | |
| 6 | | Not used | 0xAA |
| 7 | Checksum | Algebraic Sum of bytes 1-6 | Sum of bytes 1-6 |

Note: Command 0x05

For continuous signal mode (CSM), the setting must be 20.1 dB below rated power. For burst mode, the setting must be between rated power and no less than 20 dB below rated power.

Command 0x03, Data Byte 2

The smallest delay is 0x01, which is 1 ms. The delay value of 0x00 is equal to 0xFF and gives a 256 ms delay. The delay value of 0xAA is the only exception; it will not

change anything. It aims to maintain compatibility with previous versions of the software. However, the delay time might not be accurate when the EEPROM write command is being executed (delay time longer by a few ms).

Legacy Response Message Structure

See [Data Field Definitions](#) on [page D-5](#) for valid settings.

Table D.2 Response to IBUC Commands 0x01, 0x02, 0x03, 0x04, 0x08, and 0xFF

| Byte | Name | Description | Value |
|------|---------------|---|-------------------------------|
| 1 | Address | Reports IBUC Address shifted left by 4 bits | 0x10 to 0xF0 |
| 2 | Level Byte 1 | Reports current Tx output power MSB | MSB |
| 3 | Level Byte 2 | Reports current Tx output power LSB | LSB |
| 4 | Temperature | Reports Housing Temperature in °C | |
| 5 | Status Byte 1 | | |
| | Bit 0: | Housing Temperature | 1=Out of 0=Normal |
| | Bit 1: | PLDRO lock | 1=Out of Lock 0=Normal |
| | Bit 2: | Checksum | 1= Command Error 0= Normal |
| | Bit 3: | Tx status | 1=On, 0=Off |
| | Bits 4 to 7: | Power class | 0x1 to 0xA |
| 6 | Status Byte 2 | | |
| | Bits 0 to 3: | Summary Alarm = On | 0x9 |
| | | Summary Alarm = Off | 0xA |
| | Bits 4 to 7: | Software version | 0x0 to 0xF |
| 7 | Checksum | Algebraic Sum of bytes 1-6 | Sum of bytes |

Table D.3 Response to IBUC Commands 0x05 and 0x06
(When Data Byte 1 of Command Message = 0x00)

| Byte | Name | Description | Value |
|------|--------------|--|--------------|
| 1 | Address | Address of IBUC Shifted Left by 4 bits | 0x10 to 0xF0 |
| 2 | Level Byte 1 | Current Tx Output Power (Burst Mode) | MSB |
| 3 | Level Byte 2 | Current Tx Output Power (Burst Mode) | LSB |
| 4 | Level Byte 3 | Current Power Threshold | MSB |
| 5 | Level Byte 4 | Current Power Threshold | LSB |

Table D.3 Response to IBUC Commands 0x05 and 0x06
(When Data Byte 1 of Command Message = 0x00) (Continued)

| Byte | Name | Description | Value |
|------|--------------|----------------------------|--------------|
| 6 | Bits 0 to 3: | If Command = 0x05 | 0xB |
| | | If Command = 0x06 | 0xC |
| | Bits 4 to 7: | | 0x00 |
| 7 | Checksum | Algebraic Sum of bytes 1-6 | Sum of bytes |

Table D.4 Response to IBUC Command 0x06
(When Data Byte 1 of Command Message = 0x01)

| Byte | Name | Description | Value |
|------|--------------|---|--------------|
| 1 | Address | Address of IBUC Shifted Left by 4 bits | 0x10 to 0xF0 |
| 2 | Level Byte 1 | Max Stored Tx Output Power (Burst Mode) | MSB |
| 3 | Level Byte 2 | Max Stored Tx Output Power (Burst Mode) | LSB |
| 4 | Level Byte 3 | Min Stored Tx Output Power (Burst Mode) | MSB |
| 5 | Level Byte 4 | Min Stored Tx Output Power (Burst Mode) | LSB |
| 6 | Bits 0 to 3: | | 0xD |
| | Bits 4 to 7: | | 0x00 |
| 7 | Checksum | Algebraic Sum of bytes 1-6 | Sum of bytes |

Table D.5 Response to IBUC Command 0x07

| Byte | Name | Description | Value |
|------|----------------------|---|--------------|
| 1 | Address | Address of IBUC Shifted Left by 4 bits | 0x10 to 0xF0 |
| 2 | Bits 0 to 3: | Manufacturer ID | 2 |
| | Bits 4 to 7: | Frequency Band ID | 1 to 15 |
| 3 | Serial Number Byte 1 | Decimal Digits 1 and 2 of Serial Number | 0000 to 1001 |
| 4 | Serial Number Byte 2 | Decimal Digits 3 and 4 of Serial Number | 0000 to 1001 |
| 5 | Serial Number Byte 3 | Decimal Digits 5 and 6 of Serial Number | 0000 to 1001 |
| 6 | Bits 0 to 3: | | 0xD |
| | Bits 4 to 7: | | 0x0 |
| 7 | Checksum | Algebraic Sum of bytes 1-6 | Sum of bytes |

Table D.6 Response to IBUC Command 0x09

| Byte | Name | Description | Value |
|------|-------------|--|-------------------------|
| 1 | Address | Address of IBUC Shifted Left by 4 bits | 0x10 to 0xF0 |
| 2 | Data Byte 1 | Temperature Shutdown @ Temp State | 0x00 = Off 0x01 = On |
| 3 | Data Byte 2 | Minimum Stored Unit Temperature (Two's Complement if below 0) | 0x00...0xFF |
| 4 | Data Byte 3 | Maximum Stored Unit Temperature (Two's Complement if below 0) | 0x00...0xFF |
| 5 | Data Byte 4 | Number of Writes to Temperature Memory After Memory was Cleared or Unit Rebooted | 0x00...0xFF |
| 6 | | Not Used | |
| 7 | Checksum | Algebraic Sum of bytes 1-6 | Sum of bytes |

Data Field Definitions

[Table D.7](#) contains data field definitions.

Table D.7 Data Field Definitions

| Byte | Name | Description |
|------|--------------------|--------------------------|
| 1 | IBUC Address: | Integer between 1 and 15 |
| 2 | Tx Power Level: | Integer in 1/100 dBm |
| 3 | Detect threshold | Integer in 1/100 dBm |
| 4 | Carrier Frequency: | Integer in MHz |
| 5 | Temperature: | Character in °C |

Table D.7 Data Field Definitions (Continued)

| Byte | Name | Description |
|---------|------------------|-------------|
| 6 | Power Class: | |
| | 2 Watt | 1 |
| | 4 Watt | 2 |
| | 5 Watt | 3 |
| | 8 Watt | 4 |
| | 10 Watt | 5 |
| | 16 Watt | 6 |
| | 20 Watt | 7 |
| | 25 Watt | 8 |
| | 40 Watt | 9 |
| | 60 Watt | 10 (A) |
| | 30 Watt | 11 (B) |
| | 80 Watt | 12 (C) |
| | 100 Watt | 13 (D) |
| | 12 Watt | 14 (E) |
| 50 Watt | 15 (F) | |
| 7 | Frequency Band | |
| | Standard C-band | 3 |
| | Insat C-band | 4 |
| | Extended Ku-band | 5 |
| | Standard Ku-band | 6 |
| | X-band | 7 |
| | Full Ku-band | 8 |
| | Extended C-band | 9 |
| | Full C-band | 10 |
| | Low Ku-band | 11 |
| | Palapa C-band | 12 |
| | DBS-band 1 | 14 |
| | DBS-band 2 | 15 |

Table D.7 Data Field Definitions (Continued)

| Byte | Name | Description | | | | | | | | | | | | | | | | | | | | | |
|--------|------|--|------|--------|------|--------|--|--------|--|--------|--|------|------|------|------|------|------|---|---|---|---|---|---|
| | | <p>The data word consists of 3 bytes of which 4 bits are reserved for each respective decimal digit. If the serial number consists of fewer than 6 decimal digits, the remaining digits are filled by zeros (0). For example: serial number 129 would appear as follows:</p> <table data-bbox="472 478 1224 579"> <thead> <tr> <th data-bbox="472 478 561 510">Byte 1</th> <th data-bbox="561 478 716 510"></th> <th data-bbox="716 478 805 510">Byte 2</th> <th data-bbox="805 478 959 510"></th> <th data-bbox="959 478 1049 510">Byte 3</th> <th data-bbox="1049 478 1224 510"></th> </tr> </thead> <tbody> <tr> <td data-bbox="472 510 561 541">1001</td> <td data-bbox="561 510 716 541">0100</td> <td data-bbox="716 510 805 541">1000</td> <td data-bbox="805 510 959 541">0000</td> <td data-bbox="959 510 1049 541">0000</td> <td data-bbox="1049 510 1224 541">0000</td> </tr> <tr> <td data-bbox="472 541 561 573">9</td> <td data-bbox="561 541 716 573">2</td> <td data-bbox="716 541 805 573">1</td> <td data-bbox="805 541 959 573">0</td> <td data-bbox="959 541 1049 573">0</td> <td data-bbox="1049 541 1224 573">0</td> </tr> </tbody> </table> | | | | Byte 1 | | Byte 2 | | Byte 3 | | 1001 | 0100 | 1000 | 0000 | 0000 | 0000 | 9 | 2 | 1 | 0 | 0 | 0 |
| Byte 1 | | Byte 2 | | Byte 3 | | | | | | | | | | | | | | | | | | | |
| 1001 | 0100 | 1000 | 0000 | 0000 | 0000 | | | | | | | | | | | | | | | | | | |
| 9 | 2 | 1 | 0 | 0 | 0 | | | | | | | | | | | | | | | | | | |

This page intentionally left blank
for double-sided printing.

IBUC HAND-HELD TERMINAL MENU TREE

Menu Options

Beginning with firmware version 1.00, the structure of the hand-held terminal's menu tree and menu options has changed. [Figure E.3](#) on [page E-3](#) illustrates the updated menu tree and the available options when using the hand-held terminal (HHT). Those options are described in this appendix.

To enable the HHT,

1. Connect the HHT to the system by using the 19-pin connector.
 - When using a single IBUC, connect the HHT to the system by using the J3 connector.
 - When using redundant IBUCs, connect the HHT to the system by using the either the J1 connector (for the A: side IBUC) or the J8 connector (for the B: side IBUC).
2. When the connection is made and the HHT is receiving power, a blinking cursor appears in the upper left of the HHT display.
3. Type “. . . .” by using the decimal key on the HHT keypad.

The screen now displays the IBUC model number and serial number which are shown in [Figure E.1](#), and the system requests a password.

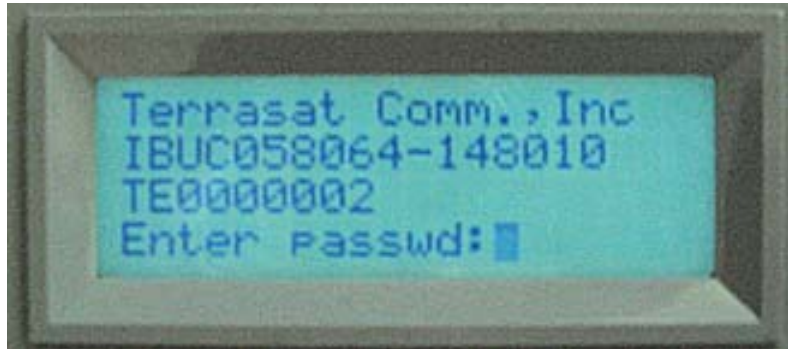

Figure E.1 Sample IBUC HHT Display

4. Type the password by using the number keys on the HHT.
The default password is 1234.
5. The “Info & Sensors” window shown in [Figure E.2](#) appears.



Figure E.2 Sample IBUC Info & Sensors Window

6. The unit is now ready to receive input.

Note: The HHT now offers “adaptive learning;” that is, you no longer need to scroll up and down through all of the menu options during a single session. For example, if a user repeatedly uses the IP Address and Clear Alarm Log options, after the first time accessing those options by using the up and down arrow keys to access the submenus, the user can now use the right and left arrows to move between submenu branches because the system “learns” to access those two options. You can continue lateral movement by using the → and ← keys.

There is no need to logout from the HHT once the session is complete. However, once the HHT is disconnected from the system or the session ends, all of the previous menu movements are lost.

HHT Log In

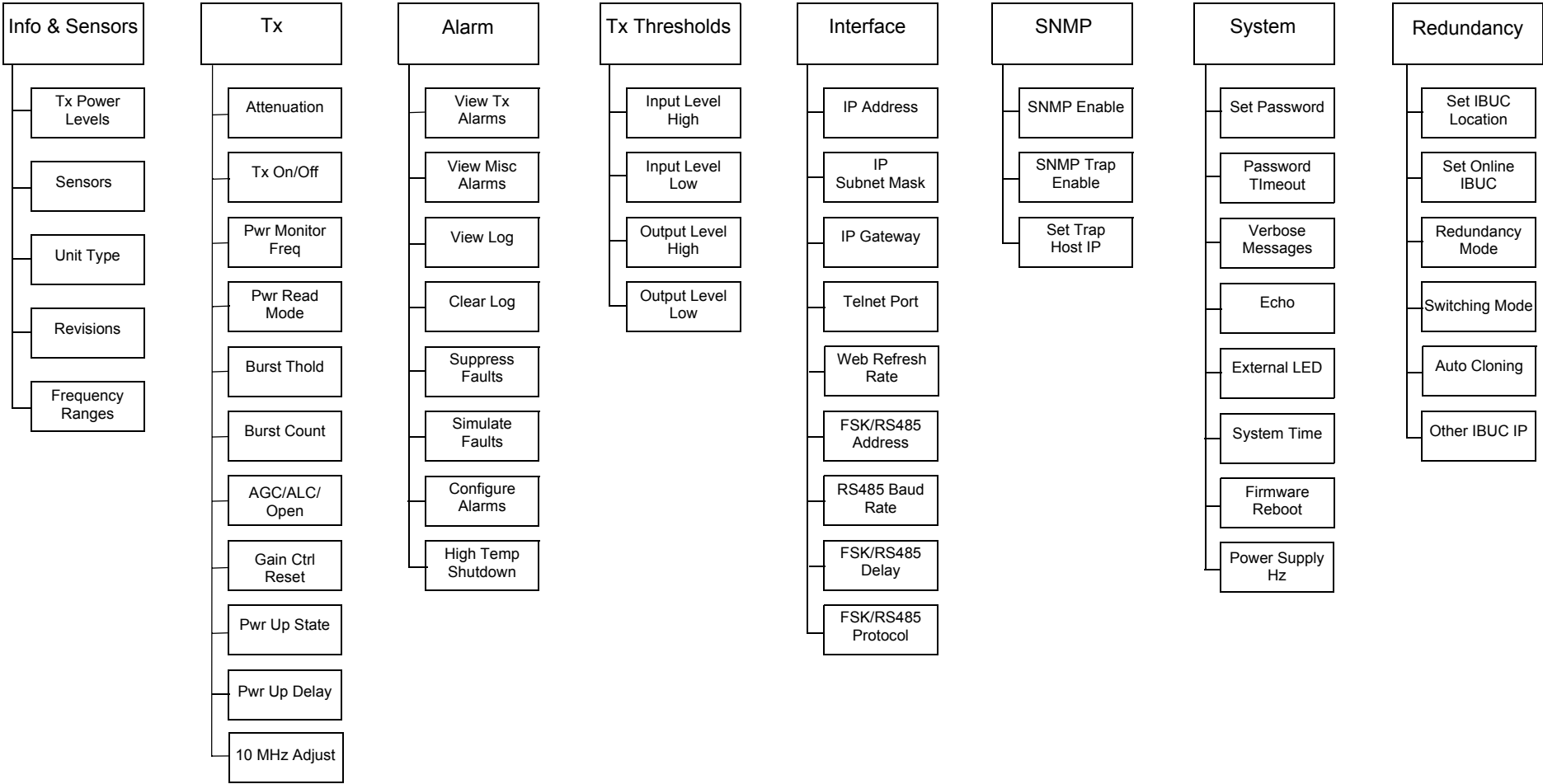

Figure E.3 IBUC Hand-held Terminal Menu Tree

Info & Sensors

Tx Power Levels – Displays the input and output power levels.

Sensors – Displays unit power supply voltage, current, DRO voltage, temperature, and 10 MHz reference state.

Unit Type – Displays frequency band name, rated wattage, and DC voltage required.

Revisions – Displays firmware and hardware revision strings.

Frequency Ranges – Displays LO frequency, RF frequency range, and IF frequency range.

Tx

Attenuation – Displays or sets gain attenuator.

Tx On/Off – Displays or sets whether the transmitter is enabled/disabled.

Pwr Monitor Freq – Displays or sets the frequency for power readings from the IBUC.

Pwr Read Mode – Displays or sets whether the power reading is collected continuously or only during bursts.

Burst Thold – Displays or sets the level that determines a valid burst when Pwr Read Mode is set to burst.

Burst Count – Displays or sets the number of bursts to average for the power reading when Pwr Read Mode is set to burst.

AGC/ALC/Open – Displays or sets the gain mode of the unit.

Gain Ctrl Reset – Displays the current gain control setting, or sets the gain control to 0.

Pwr Up State – Displays or sets the transmitter state at power up.

Pwr Up Delay – Displays or sets the off time of the transmitter before enabling at power up.

10 MHz Adjust – Displays or sets the internal 10 MHz frequency trimming value.

Alarm

View Tx Alarms – Displays current transmitter alarms.

View Misc Alarms – Displays current miscellaneous alarms.

View Log – Displays the unit alarm log.

Clear Log – Clears the unit alarm log.

Suppress Faults – Displays or sets whether alarms configured for suppression are suppressed.

Simulate Fault – Displays or sets a major transmitter alarm (used for troubleshooting).

Configure Alarms – Displays or sets whether individual alarms cause a major/minor/no alarm and if the alarm is suppressible.

Hi Temp Shutdown – Displays or sets the high temperature shutdown setting of the unit.

Tx Thresholds

Input Level High – Displays or sets the input power high threshold.

Input Level Low – Displays or sets the input power low threshold.

Output Level High – Displays or sets the output power high threshold.

Output Level Low - Displays or sets the output power low threshold.

Interface

IP Address – Displays or sets the IP address of the unit.

IP Subnet Mask – Displays or sets the subnet mask of the unit.

IP Gateway – Displays or sets the IP gateway of the unit.

Telnet Port – Displays or sets the TCP port used for Telnet communications.

Web Refresh Rate – Displays or sets the rate at which web pages will request updates.

FSK/485 Address – Displays or sets the address used for both the FSK and RS485 links.

RS485 Baud Rate – Displays or sets the baud rate for RS485 communications.

FSK/485 Delay – Displays or sets the amount of time the unit delays sending a response to a command.

FSK/485 Protocol – Displays or sets the whether the unit communicates with ASCII protocol or Binary protocol on both the FSK and RS485 links.

SNMP

SNMP Enable – Displays or sets whether SNMPV1 is enabled or not.

SNMP Trap Enable – Displays or sets whether the unit will generate traps. Only valid when SNMP Enable is enabled.

Set Trap Host IP – Displays or sets the IP address that traps will be directed to.

System

Set Password – Changes the password for the unit. Affects all modes of access.

Password Timeout – Displays or sets the inactivity time before the unit automatically logs the user off.

Verbose Messages – Displays or sets the format of the replies to commands on all links.

Echo – Displays or sets whether the unit responds to set commands.

External LED – Displays or sets whether the external LEDs are used.

System Time – Displays or sets the current system real time clock.

F/W Reboot – Causes the firmware to reboot.

Power Supply Hz – When enabled, applies a 50 Hz correction to AC-powered IBUCs. This command is not available for DC-powered IBUCs.

Redundancy

This menu item will appear only if the IBUC is part of a TX1+1 system and you are connecting through the interface box.

Set IBUC Location – Displays or sets the position this IBUC transmitter occupies on the waveguide switch.

Set Online IBUC – Displays or change the physical position of the waveguide switch.

Redundancy Mode – Displays or sets whether the unit is free to switch once or multiple times on a failure.

Switching Mode – Displays or sets whether the unit switches manually or due to unit alarms.

Auto Cloning – Displays or sets whether the slave unit is updated when parameters are changed on the master unit.

Other IBUC IP – Displays or sets the partner unit IP address.

This page intentionally left blank
for double-sided printing.

F

IBUC WEB PAGES

The embedded Web pages shown in this appendix are a user-friendly way to access the various monitor and control (M&C) features offered by the IBUC.

Most of the screen shots from the Web interface shown in this appendix are from a transmit redundant (Tx 1+1) system. The main data area below the tabs is split into two identical windows for the A: side IBUC and the B: side IBUC. In a single IBUC system, only a single data window is displayed.

Introduction

To access the embedded Web pages,

1. Connect the host computer to the IBUC.
 - When using a single IBUC, connect a TCP/IP cable to the 19-pin J2 connector on the IBUC.
 - When using a Tx 1+1 redundant system, connect a TCP/IP cable to the 19-pin J3 connector labeled “User Interface Port” on the redundant system interface box.
2. Choose “Start,” and then “Control Panel.”
3. Choose “Network Connections.”
4. Choose “Local Area Connection.”
The Local Area Connection Status window shown in [Figure F.1](#) appears.

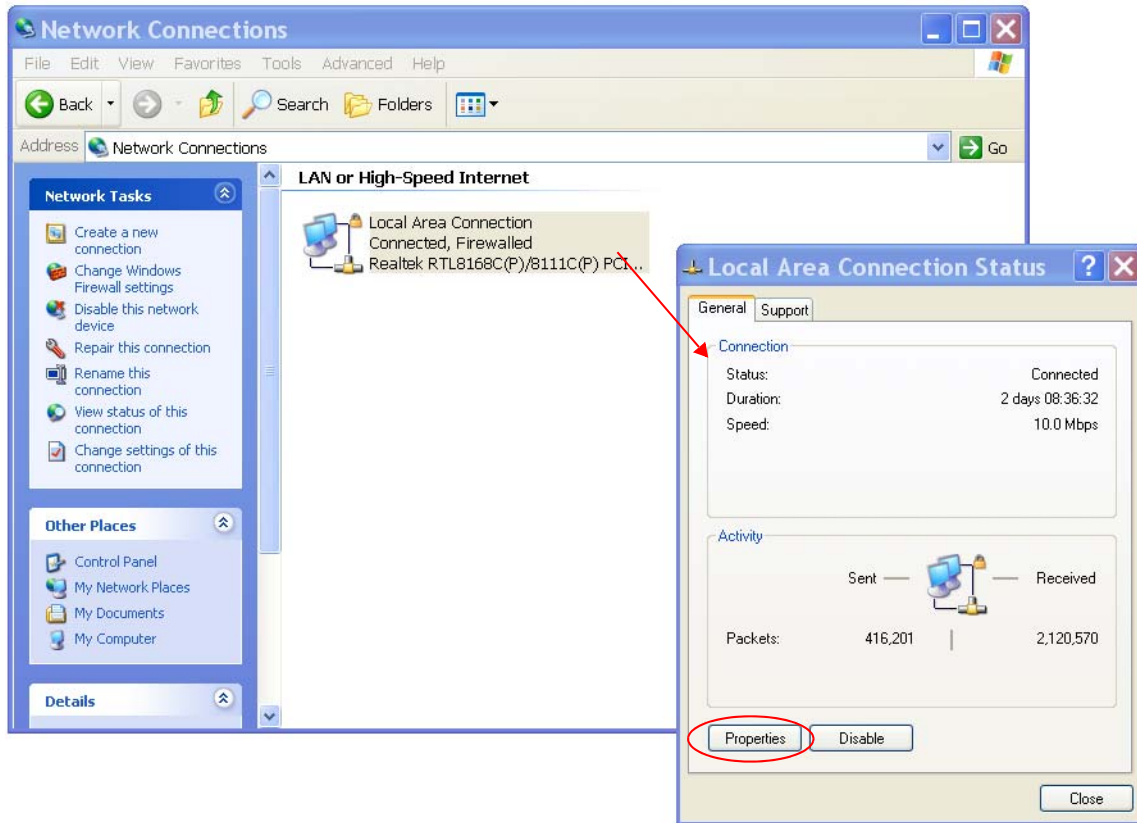

Figure F.1 Choosing Network Connections

5. Click Properties.
The window shown in Figure F.2 appears.

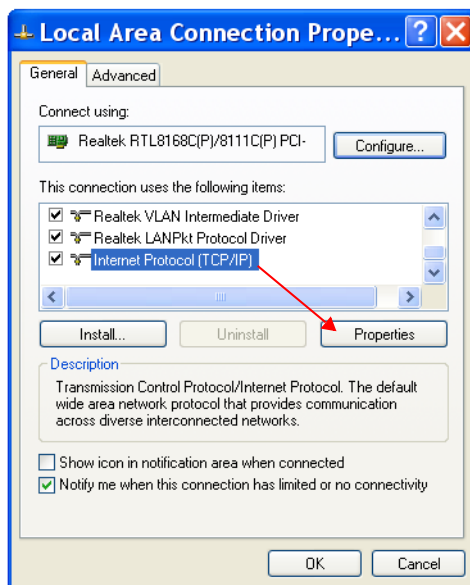

Figure F.2 Choosing the Internet Protocol (TCP/IP) Properties

6. In the dialog window, scroll down until “Internet Protocol (TCP/IP)” becomes visible.
7. Select “Internet Protocol (TCP/IP).”
As shown in [Figure F.2](#), it will become highlighted once you select it.
8. Click Properties.
The window shown in [Figure F.3](#) appears.

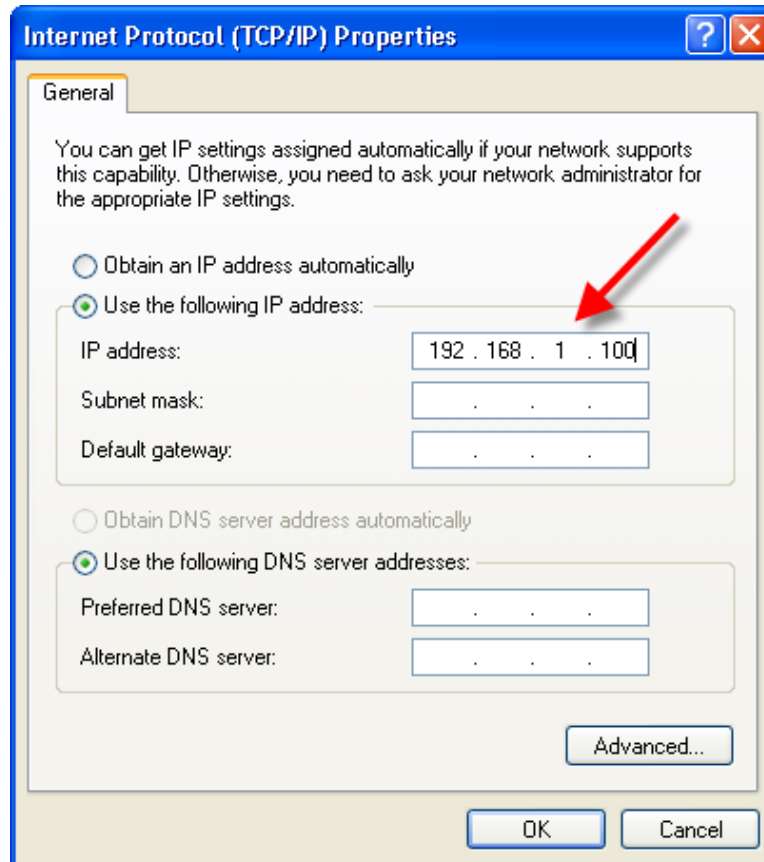

Figure F.3 Typing the IP Address

9. Select “Use the following IP address,” and then type an IP address.
This IP address cannot be the same address as the IBUC. In [Figure F.3](#), 192.168.1.100 is an example, assuming that the IBUC is using its default IP address (192.168.1.21).

10. Click OK.

The error message shown in [Figure F.4](#) appears.

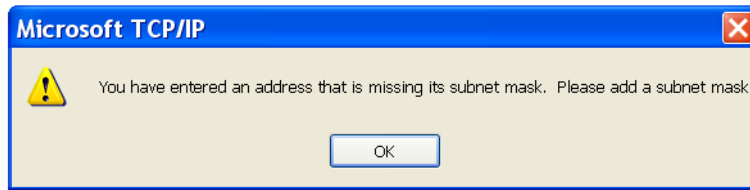

Figure F.4 Invalid Subnet Mask Error Message

11. Click OK.

This causes the “Subnet Mask” fields to be filled in with the default subnet mask address.

12. Click OK.

13. Using the host computer, activate a Web browser window.

14. Type the IP address of the IBUC in the address window, and then click Enter.

The IP address of the IBUC was assigned at the factory and is shown in the test data that accompanies the unit.

- In a single IBUC, the factory default IP address is <http://192.168.1.21>
- In a Tx 1+1 system, the factory default IP address for the A: side IBUC is <http://192.168.1.21>
The factory default IP address for the B: side IBUC is <http://192.168.1.22>

Note: Your computer should have a static IP address on the same subnet as the Rx 1+1 system.

15. Within a few seconds, the Login page shown in [Figure F.5](#) on [page F-5](#) will appear.

Screen Shots

Login

This page appears to prompt you to login to the system. You can login or logout from any of the tabs shown in [Figure F.5](#).

Type your password in the dialog box, and then click Login. The default value is 1234. If the login password that you entered is accepted, the page of the highlighted tab appears. In [Figure F.5](#), the Info tab is highlighted; thus, the Info tab will appear upon successful login. If the login password entered is incorrect, the screen remains unchanged.

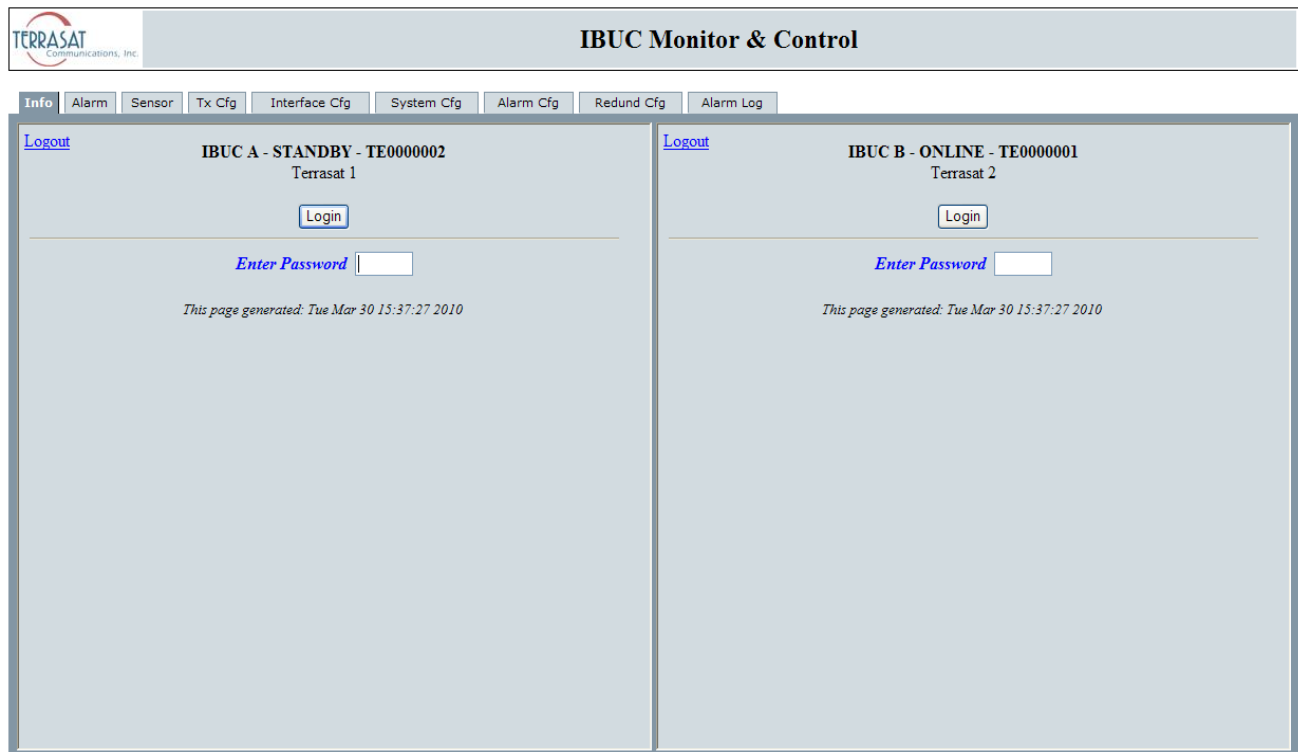

The screenshot displays the 'IBUC Monitor & Control' web interface. At the top left is the TERRASAT logo. The main title is 'IBUC Monitor & Control'. Below the title is a navigation bar with tabs: Info, Alarm, Sensor, Tx Cfg, Interface Cfg, System Cfg, Alarm Cfg, Redund Cfg, and Alarm Log. The 'Info' tab is selected and highlighted. The main content area is split into two panels. The left panel is titled 'IBUC A - STANDBY - TE0000002 Terrasat 1' and contains a 'Logout' link, a 'Login' button, an 'Enter Password' text box, and a timestamp 'This page generated: Tue Mar 30 15:37:27 2010'. The right panel is titled 'IBUC B - ONLINE - TE0000001 Terrasat 2' and contains a 'Logout' link, a 'Login' button, an 'Enter Password' text box, and the same timestamp.

Figure F.5 Login

Information Tab

Use this tab to view read-only IBUC data such as the model number, serial number, revisions, and frequencies.

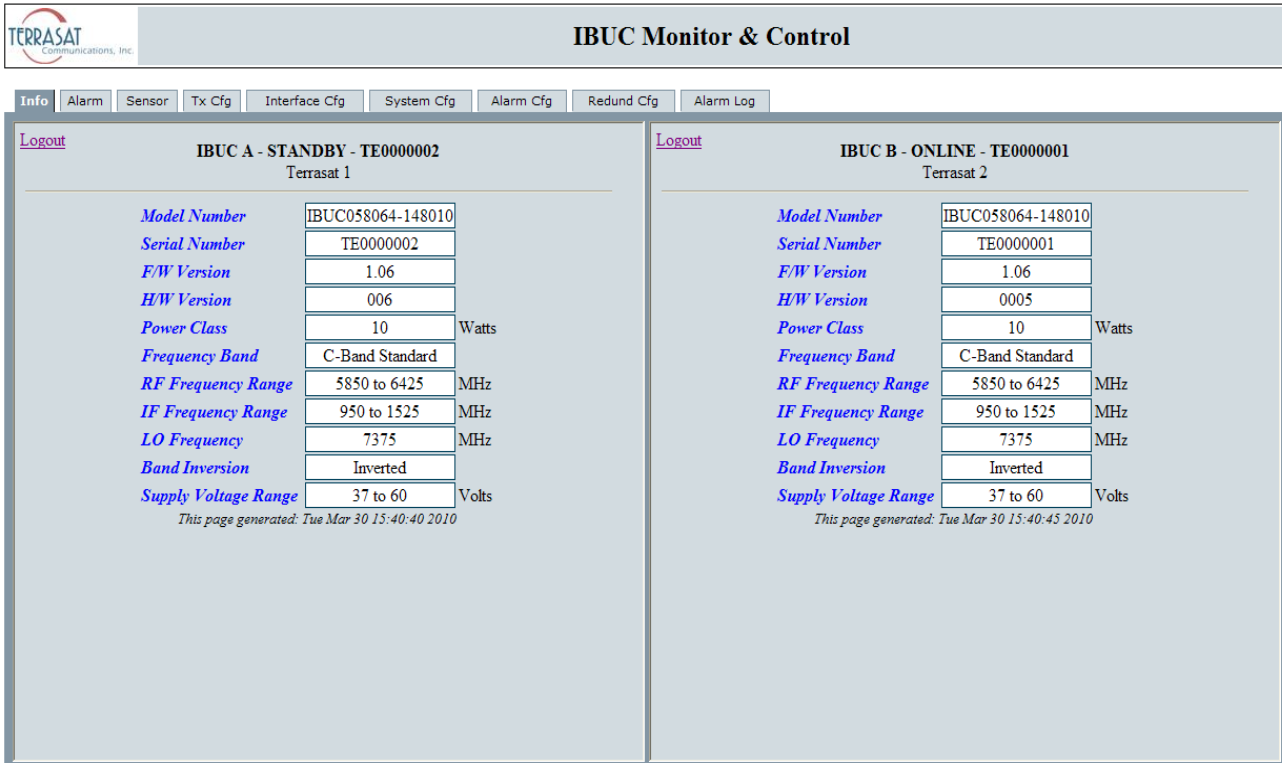

| IBUC A - STANDBY - TE0000002 | | IBUC B - ONLINE - TE0000001 | |
|------------------------------|-------------------|-----------------------------|-------------------|
| Terrasat 1 | | Terrasat 2 | |
| Model Number | IBUC058064-148010 | Model Number | IBUC058064-148010 |
| Serial Number | TE0000002 | Serial Number | TE0000001 |
| F/W Version | 1.06 | F/W Version | 1.06 |
| H/W Version | 006 | H/W Version | 0005 |
| Power Class | 10 | Power Class | 10 |
| Frequency Band | C-Band Standard | Frequency Band | C-Band Standard |
| RF Frequency Range | 5850 to 6425 MHz | RF Frequency Range | 5850 to 6425 MHz |
| IF Frequency Range | 950 to 1525 MHz | IF Frequency Range | 950 to 1525 MHz |
| LO Frequency | 7375 MHz | LO Frequency | 7375 MHz |
| Band Inversion | Inverted | Band Inversion | Inverted |
| Supply Voltage Range | 37 to 60 Volts | Supply Voltage Range | 37 to 60 Volts |

Figure F.6 Information Tab

From this page, you can view the following parameters:

- **Model Number**
Displays the model number of the IBUC(s). More information about the data contained within the part number is found in [Appendix A](#).
- **Serial Number**
Displays the unique serial number of the IBUC(s).
- **Firmware Version**
Displays the version number. The firmware version number of the IBUC is used mainly by Terrasat Technical Support personnel.
- **Hardware Version**
Displays the version number of the hardware.

Note: The hardware version can be updated only when the IBUC is returned to the factory.

- **Power Class**
Displays transmitter output power at 1 dB compression. Power class information is contained within the part number. More information about locating the power level of the IBUC is found in [Appendix A](#).
- **Frequency Band**
Displays the standard name of the band.
- **RF Frequency Range**
Displays the valid RF frequencies for the IBUC(s). The RF Frequency range for each of the various IBUC bands is listed in [Table 2.1 on page 2-2](#).
- **IF Frequency Range**
Displays the valid IF frequencies for the IBUC(s). The L-band IF Frequency range for each of the various IBUC bands is listed in [Table 2.1 on page 2-2](#).
- **LO Frequency**
Displays the valid LO frequencies for the IBUC(s). The LO Frequency for each of the various IBUC bands is listed in [Table 2.1 on page 2-2](#).
- **Band Inversion**
Options include:
 - Non-Inverted
 - Inverted
When inverted, the relationship between the RF and IF frequencies is inverse; that is, as the RF Frequency increases, the lower the IF Frequency from the modem must be.
- **Supply Voltage Range**
Displays the power supply voltage range for which the IBUC was designed. The Supply Voltage Range is based on the configuration of your IBUC(s).

Alarm Tab

Use this tab to verify the alarm status of the unit. Alarm status is indicated with color and text: a green background indicates that that parameter is operating within specifications and no faults have occurred, a yellow background indicates a minor fault, and a red background indicates a major fault. A white background indicates that particular parameter is not available for monitoring. [Table 5.1](#) on [page 5-4](#) contains the default configuration and lists which alarms are available for user configuration.

See the [Alarm Configuration Tab](#) on [page F-24](#) for information about how to configure these alarms.

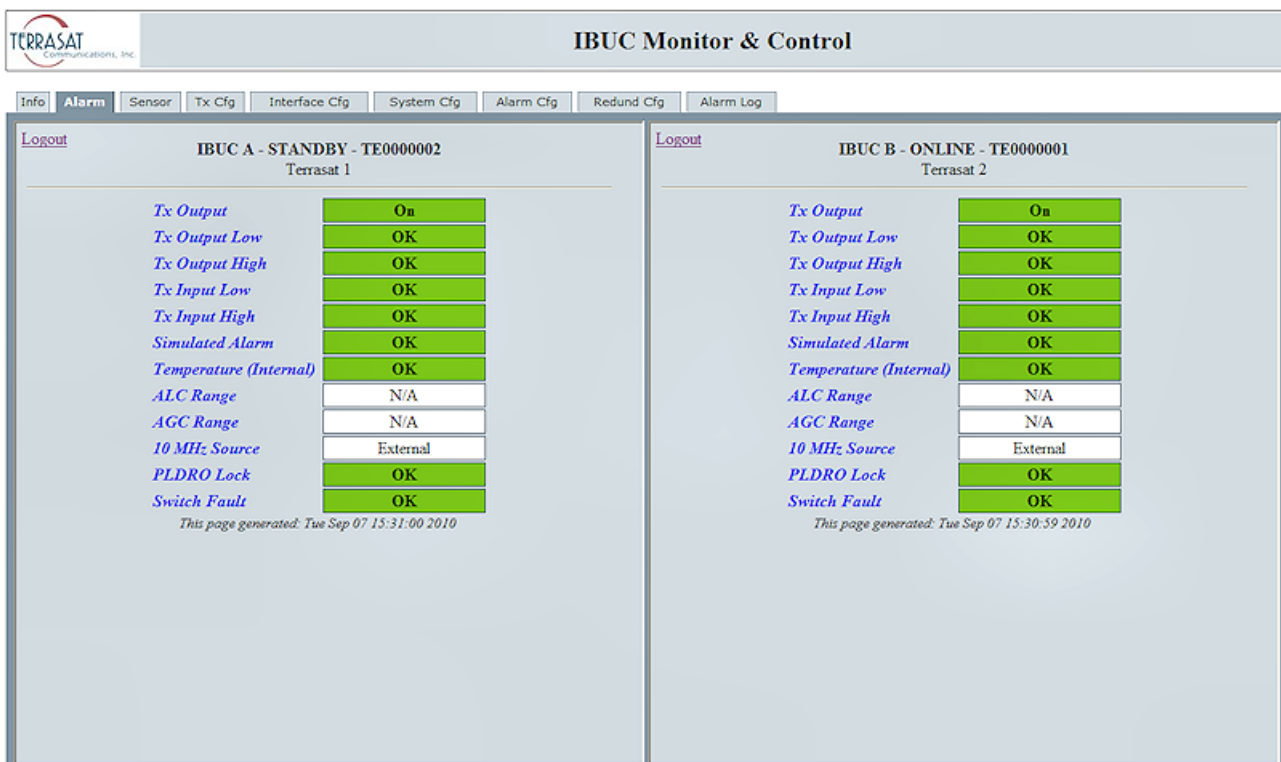

The screenshot displays the 'IBUC Monitor & Control' interface. At the top, there is a navigation bar with tabs: Info, Alarm, Sensor, Tx Cfg, Interface Cfg, System Cfg, Alarm Cfg, Redund Cfg, and Alarm Log. The 'Alarm' tab is selected. Below the navigation bar, there are two main panels for IBUC A and IBUC B.

IBUC A - STANDBY - TE0000002
Terrasat 1

| | |
|------------------------|----------|
| Tx Output | On |
| Tx Output Low | OK |
| Tx Output High | OK |
| Tx Input Low | OK |
| Tx Input High | OK |
| Simulated Alarm | OK |
| Temperature (Internal) | OK |
| ALC Range | N/A |
| AGC Range | N/A |
| 10 MHz Source | External |
| PLDRO Lock | OK |
| Switch Fault | OK |

This page generated: Tue Sep 07 15:31:00 2010

IBUC B - ONLINE - TE0000001
Terrasat 2

| | |
|------------------------|----------|
| Tx Output | On |
| Tx Output Low | OK |
| Tx Output High | OK |
| Tx Input Low | OK |
| Tx Input High | OK |
| Simulated Alarm | OK |
| Temperature (Internal) | OK |
| ALC Range | N/A |
| AGC Range | N/A |
| 10 MHz Source | External |
| PLDRO Lock | OK |
| Switch Fault | OK |

This page generated: Tue Sep 07 15:30:59 2010

Figure F.7 Alarm Status Tab

From this page, you can view the following parameters:

- Tx Output

Indicates whether the IBUC is currently transmitting. Options include:

- On
- Disabled
- Muted (Alarm)

- Tx Output Low
Indicates whether the Tx Output level is operating below a minimum threshold.
Options include:
 - OK
 - Major
 - Minor
 - Tx Output High
Indicates whether the Tx Output level is operating above a maximum threshold.
Options include:
 - OK
 - Major
 - Minor
 - Tx Input Low
Indicates whether the Tx Input level is operating below a minimum threshold.
Options include:
 - OK
 - Major
 - Minor
 - Tx Input High
Indicates whether the Tx Input level is operating above a maximum threshold.
Options include:
 - OK
 - Major
 - Minor
 - Simulated Alarm
Indicates whether a simulated alarm has been issued. A simulated alarm is mainly used for testing. Options include:
 - OK
 - Major
 - Temperature (Internal)
Indicates that the internal temperature of the IBUC exceeds 85 °C.
- Note: If the High Temperature Shutdown alarm has been enabled and the internal temperature of the IBUC exceeds 85 °C, the IBUC will shut down automatically.

- ALC Range

Indicates that the Tx Output level is being kept constant by the automatic level control (ALC) function. Options include:

- OK
- Out of Range

This alarm occurs whenever the gain reaches or exceeds ± 8 dB.

- N/A

Note: An alarm occurs when the IBUC can no longer maintain the Tx Output level. This alarm is coded into the IBUC and is not available for user configuration.

- AGC Range

Indicates that the automatic gain control function is unable to maintain the gain level.

- 10 MHz Source

Indicates whether the source of the 10 MHz reference signal is internal or external.

Note: For IBUCs operating with only an external 10 MHz reference signal, this field is labelled “10 MHz Detector” and the options include:

- OK (indicates that the 10 Mhz signal is functioning properly)
- Low (indicates that the 10 MHz signal is low or missing)

- PLDRO Lock

Indicates whether the phase-locked dielectric resonator oscillator (PLDRO) frequency is locked (or stable). When the PLDRO is out-of-lock, this alarm causes the muting of the amplifier and automatically shuts down the IBUC. Options include:

- OK (indicates that the PLDRO is locked and functioning properly)
- Major

Note: This alarm is always a major alarm and is not available for user configuration.

- Switch Fault

Indicates whether the waveguide switch is operating properly. This alarm is coded into the IBUC and is not available for user configuration. Options include:

- OK (indicates that the PLDRO is locked and functioning properly)
- Major

Note: This alarm is only available for redundant systems. It does not appear on the Alarm Status tab for single IBUC systems.

Sensor Tab

Use this tab to view real-time voltage, current, and power levels for the IBUC.

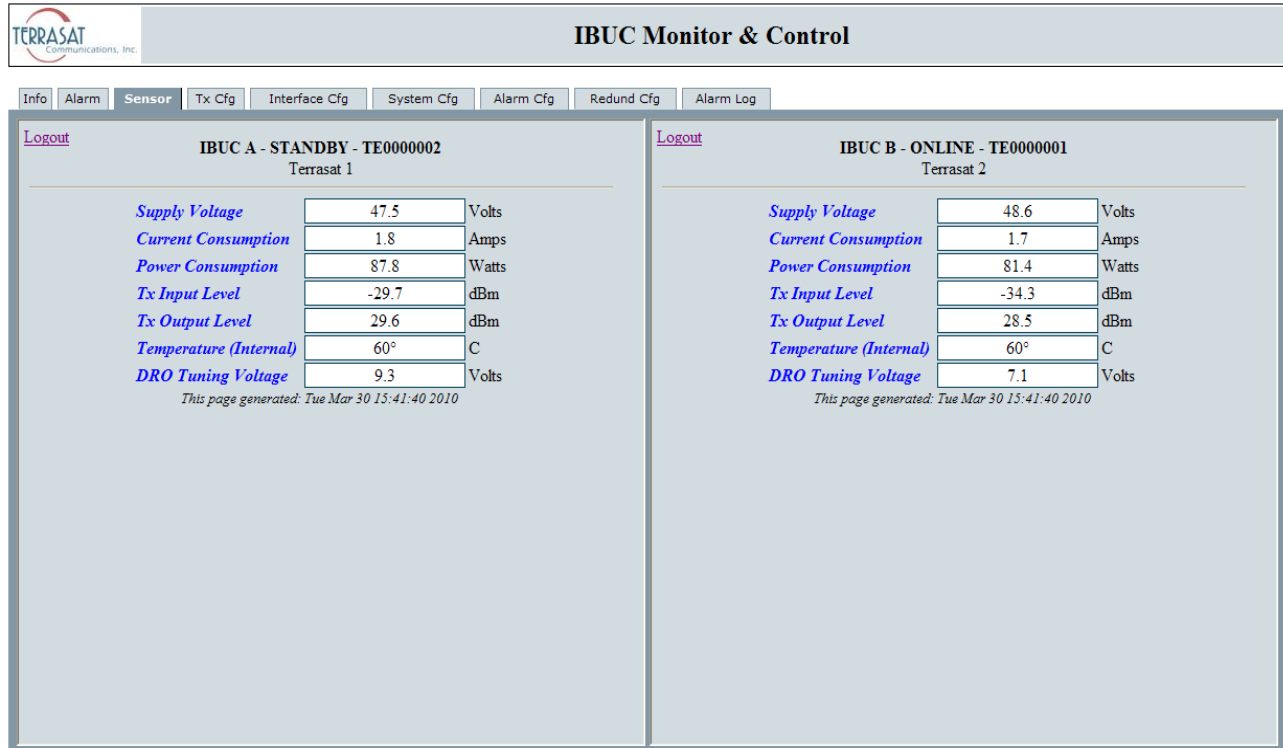

| IBUC A - STANDBY - TE0000002 Terrasat 1 | | |
|--|-------|-------|
| Supply Voltage | 47.5 | Volts |
| Current Consumption | 1.8 | Amps |
| Power Consumption | 87.8 | Watts |
| Tx Input Level | -29.7 | dBm |
| Tx Output Level | 29.6 | dBm |
| Temperature (Internal) | 60° | C |
| DRO Tuning Voltage | 9.3 | Volts |

This page generated: Tue Mar 30 15:41:40 2010

| IBUC B - ONLINE - TE0000001 Terrasat 2 | | |
|---|-------|-------|
| Supply Voltage | 48.6 | Volts |
| Current Consumption | 1.7 | Amps |
| Power Consumption | 81.4 | Watts |
| Tx Input Level | -34.3 | dBm |
| Tx Output Level | 28.5 | dBm |
| Temperature (Internal) | 60° | C |
| DRO Tuning Voltage | 7.1 | Volts |

This page generated: Tue Mar 30 15:41:40 2010

Figure F.8 Sensor Tab

From this page, you can view the following parameters:

- **Supply Voltage**
Displays the voltage reading of DC-powered IBUCs in volts; the voltage reading of AC-powered IBUCs is displayed in VAC. Valid values depend on the IBUC model. The readings on this page should fall within the range listed on the [Information Tab](#) on page F-6.
- **Current Consumption**
Displays the current draw at the input of DC-powered IBUCs in amps.
- **Power Consumption**
Displays the power consumption of the IBUC in watts. The current draw of AC-powered IBUCs is displayed in VA.
- **Tx Input Level**
Displays the Tx Input level in dBm.

- Tx Output Level

Displays the Tx Output level in dBm.

- Internal Temperature

Displays the real-time internal temperature of the IBUC in °C.

Note: If the High Temperature Shutdown alarm has been enabled and the internal temperature of the IBUC exceeds 85 °C, the IBUC will shut down automatically.

- DRO Tuning Voltage

Displays the tuning voltage for the DRO in volts. This voltage is not static and is continually monitored. The valid range is 1 to 9 volts; ideally, the DRO tuning voltage should fall within the range of 2 to 8 volts when the DRO is locked.

If your readings consistently fall within the range of 1 to 2 volts or 8 to 9 volts, contact Terrasat Technical Support.

Transmit Configuration Tab

Use this tab to configure transmission operating parameters for the IBUC. Click Save Settings when you have completed entering data to ensure that your changes are saved and then implemented.

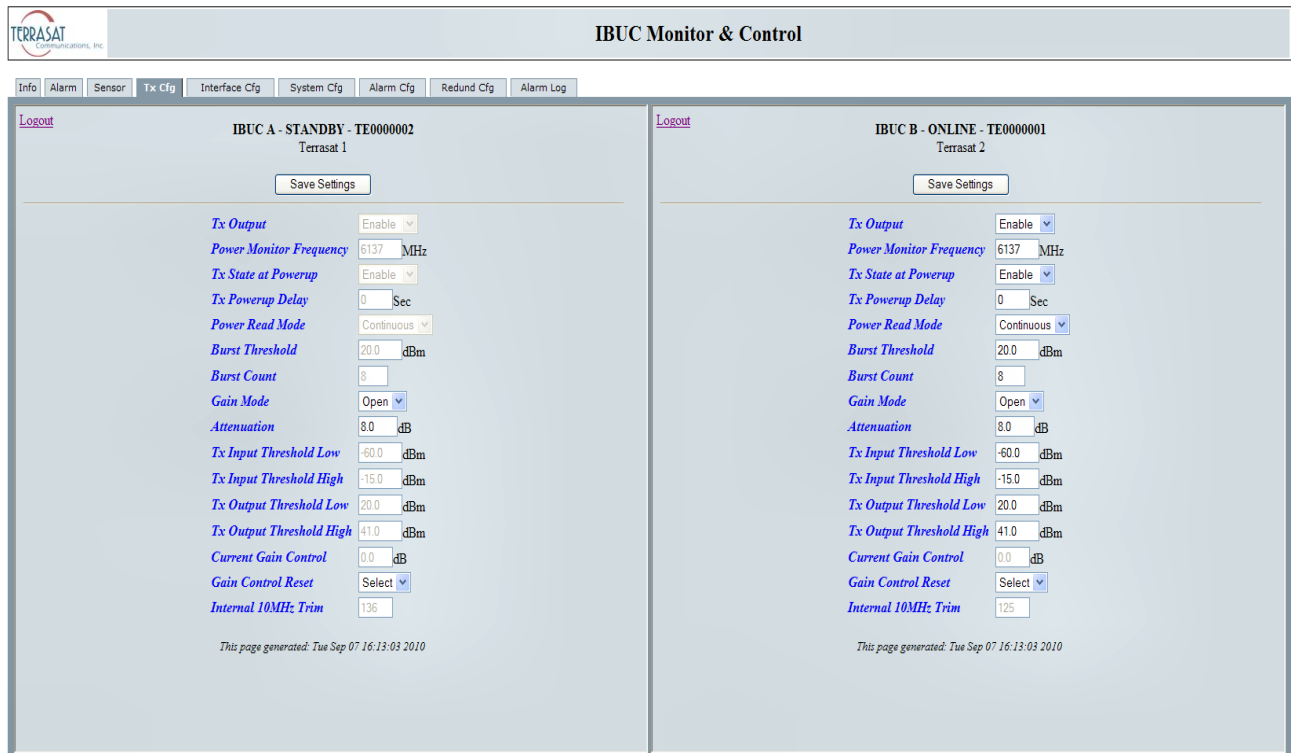

Figure F.9 Tx Configuration Tab

From this page you can configure the following parameters:

- **Tx Output**
Select whether the unit is actively transmitting. Options include:
 - Enable
 - Disable
- **Power Monitor Frequency**
Sets the Power Monitor Frequency which is the actual frequency at which you are operating. To ensure accurate readings, you must set your operating frequency which might be different from the factory default values listed in [Table F.1](#).
Example: If the frequency allocated to you by the satellite carrier is 6400 MHz, set the Power Monitor Frequency to 6400 MHz.

The factory default values in [Table F.1](#) are listed according to the model number of the IBUC. For more information about identifying the model number of the IBUC, see [Appendix A](#).

Table F.1 Default Values for Power Monitor Frequency

| Model Number | Default Value |
|--------------|---------------|
| 057064 | 6075 |
| 058064 | 6137 |
| 058066 | 6250 |
| 058067 | 6287 |
| 064067 | 6575 |
| 067070 | 6875 |
| 079084 | 8150 |
| 127132 | 13000 |
| 128133 | 13050 |
| 137142 | 14000 |
| 137145 | 14125 |
| 140145 | 14250 |
| 173181 | 17700 |
| 184184 | 18250 |
| 290300 | 29500 |
| 295300 | 29750 |
| 300310 | 30500 |

- Tx State at Powerup
Sets whether the unit is transmitting upon powerup. Options include:
 - Enable
 - Disable
- Tx Powerup Delay
Sets the transmit power output delay of the IBUC in seconds. When configured, the Tx Output will be muted for the time period specified before beginning to transmit.

- Power Read Mode

Sets the mode in which power is read. Options include:

- Burst

In burst mode, the signal is active only a small percentage of the time because packets of data are sent in bursts.

- Continuous

In continuous mode, the signal continues without interruption.

- Burst Threshold

Sets the burst threshold for the IBUC. This value determines the level at which a burst is considered valid. The threshold is for the output power level; the threshold for input power is configured internally.

The value must be between rated power and no less than 2 dB below rated power. Default values are listed in [Table F.2](#).

Table F.2 Default Values for the Burst Threshold

| Power Level | Default Value |
|-------------|---------------|
| 002 | 13.0 |
| 004 | 16.0 |
| 005 | 17.0 |
| 008 | 19.0 |
| 010 | 20.0 |
| 012 | 21.0 |
| 016 | 22.0 |
| 020 | 23.0 |
| 025 | 24.0 |
| 030 | 25.0 |
| 040 | 26.0 |
| 046 | 26.0 |
| 050 | 27.0 |
| 060 | 28.0 |
| 080 | 29.0 |
| 100 | 30.0 |
| 125 | 31.0 |

Table F.2 Default Values for the Burst Threshold

| Power Level | Default Value |
|-------------|---------------|
| 150 | 32.0 |
| 175 | 32.4 |
| 200 | 33.0 |

- **Burst Count**
Sets the burst count of the IBUC.
- **Gain Mode**
Options include:
 - Open is the gain obtained when there is no feedback in the measuring loop. Keep in mind the open-loop gain is affected by temperature and frequency; however, the temperature compensation feature is still active when the unit operates with open-loop gain. Open is the default setting.
 - Automatic Gain Control (AGC)
 - Automatic Level Control (ALC)
- **Attenuation**
Type a value within the range of 0.0 dB to 16.0 dB in 0.1 dB steps. After you click Save Settings, the gain of the unit will be reduced by that value.
 - The default setting is 0.0 dB
- **Tx Input Threshold Low**
Sets the lowest permitted transmit input value down to -60 dBm. You will receive an error message if you try to exceed the threshold range. Click OK to return to the Tx Config page to enter a valid value.
- **Tx Input Threshold High**
Sets the highest permitted transmit input value up to -15 dBm. You will receive an error message if you try to exceed the threshold range. Click OK to return to the Tx Config page to enter a valid value.
- **Tx Output Threshold Low**
Sets the lowest permitted transmit input value down to (rated P1dB - 20 dB). You will receive an error message if you try to exceed the threshold range. Click OK to return to the Tx Config page to enter a valid value.
- **Tx Output Threshold High**
Sets the highest permitted transmit input value up to (rated P1dB+ 1 dB). You will receive an error message if you try to exceed the threshold range. Click OK to return to the Tx Config page to enter a valid value.

- Current Gain Control

This option is always greyed-out. The Gain Control represents the current gain of the AGC/ALC voltage variable attenuator (VVA) circuitry. The Gain Control range is -8.0 dB to 8.0 dB. When the Gain Control Reset option is selected, this value will reset to 0.0 (midrange).

- Gain Control Reset

Over time, gain control levels can fluctuate. When the Gain Control Reset option is enabled, the gain control resets to 0.0 (midrange) Options include:

- Select (default)
- Reset

Note: You must choose “Reset” and then click Save Settings in order to reset the gain control.

- Internal 10 MHz Trim

You can specify a frequency trimming value for IBUCs equipped with the optional internal 10 MHz reference signal

Valid values: 0– 255

Note: When the IBUC is operating using an external 10 MHz reference signal, this field is greyed-out and unavailable for user input.

Interface Configuration Tab

Use this tab to configure the interfaces (TCP/IP or RS485/FSK). You can also specify SNMP settings. Click Save Settings when you have completed entering data to ensure that your changes are saved and then implemented.

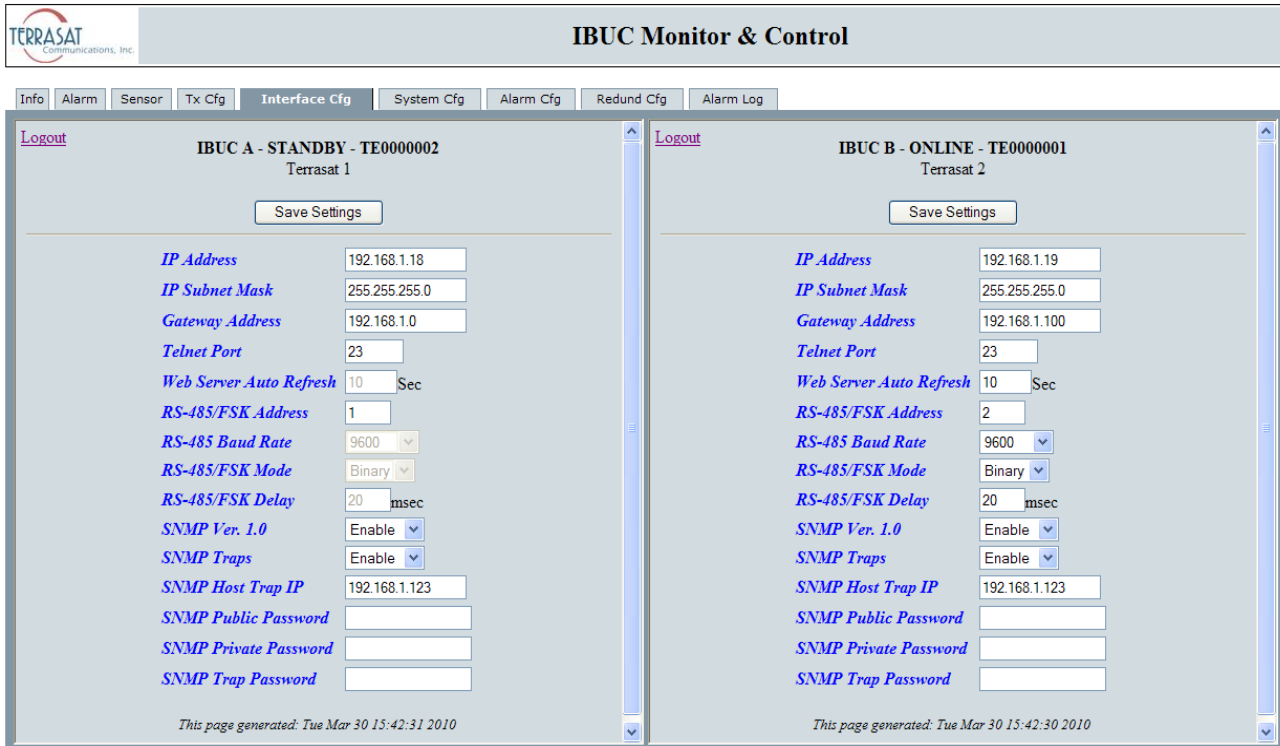

The screenshot displays the 'IBUC Monitor & Control' web interface. At the top, there is a navigation bar with tabs for 'Info', 'Alarm', 'Sensor', 'Tx Cfg', 'Interface Cfg' (selected), 'System Cfg', 'Alarm Cfg', 'Redund Cfg', and 'Alarm Log'. Below the navigation bar, there are two side-by-side configuration panels. The left panel is for 'IBUC A - STANDBY - TE0000002' and the right panel is for 'IBUC B - ONLINE - TE0000001'. Both panels have a 'Logout' link at the top left and a 'Save Settings' button at the top right. Each panel contains a list of configuration parameters with input fields or dropdown menus. The parameters include IP Address, IP Subnet Mask, Gateway Address, Telnet Port, Web Server Auto Refresh, RS-485/FSK Address, RS-485 Baud Rate, RS-485/FSK Mode, RS-485/FSK Delay, SNMP Ver. 1.0, SNMP Traps, SNMP Host Trap IP, SNMP Public Password, SNMP Private Password, and SNMP Trap Password. At the bottom of each panel, it says 'This page generated: Tue Mar 30 15:42:31 2010'.

Figure F.10 Interface Configuration Tab

From this page you can configure the following parameters:

- IP Address
Valid values range from (but do not include) 1.0.0.0 through 224.0.0.0. When the netmask is applied, 0 and 225 in the last byte are excluded.
- IP Subnet Mask
Sets the IP netmask.
 - Valid values range from 8 through 30 representing the number of ones in the netmask. This corresponds to 22.0.0.0 to 255.255.255.252.
- Gateway Address
Sets the IP Gateway Address which is the address that the IBUC will send to if the requested IP address does not reside on the local LAN segment.

Note: This address cannot be the same as the IP address of the unit.

- **Telnet Port**

Telnet is a network protocol used to establish remote communication. Ports are specific channels for network services. In the IBUC, the default Telnet port is 23.
Valid values include port numbers within the range of 1 to 65535.
 - **Web Server Auto Refresh**

Sets the rate in seconds in which the Web page refreshes. The default is 0.
Valid values: 0 to 3600
- Note:** When set to 0 sec (the factory default), the Web page will **not** refresh.
- **RS485/FSK Address**

Sets a unique designator for the unit.
Valid values for Legacy Binary: 1 to 15
Valid values for ASCII: 1 to 254
 - **RS485 Baud Rate**

Sets the baud rate at which data is sent. The default is 9600 baud.
Valid values include: 1200, 2400, 4800, 9600, 38400, 57600, or 115200.
 - **RS485/FSK Mode**

Sets the transmission protocol. Options include:

 - ASCII
 - Binary Mode (default)
 - **RS485/FSK Delay**

Sets the delay in msec between the end of one transmission and the beginning of reception in half-duplex mode.
Valid values include 1 to 255. and the default value is 20.
 - **SNMP Version 1.0**

SNMP is a communication protocol used for managing TCP/IP networks. When enabled, the unit will respond to SNMPv1 requests. Options include:

 - Enable (default)
 - Disable

- **SNMP Traps**

Sets the generation of SNMPv1 traps. SNMP traps are one-way messages that are initiated by a network element to indicate status changes and sent to the network management system. After receiving the message, the manager displays it and can choose to take an action based on the event. Options include:

 - Enable (default)
 - Disable
- **SNMP Host Trap IP**

Sets the IP address to which the network management system sends traps.
- **SNMP Public Password**

The SNMP public password (or community string) is used for requesting information from the IBUC. The password cannot exceed 16 alphanumeric characters.
- **SNMP Private Password**

The SNMP private password (or community string) is used for making changes to the IBUC. The password cannot exceed 16 alphanumeric characters.
- **SNMP Trap Password**

Sets the password for the trap manager. The password cannot exceed 16 alphanumeric characters.

Note: Changing the SNMP passwords requires a firmware reboot.

System Configuration Tab

Use this tab to set the system password and the password timeout. You can also reset (reboot) the controller card from here. Additionally, you can set the system time here. Click Save Settings when you have completed entering data to ensure that your changes are saved and then implemented.

Note: The screen in [Figure F.11](#) is the one that appears when you have a single AC-powered IBUC.

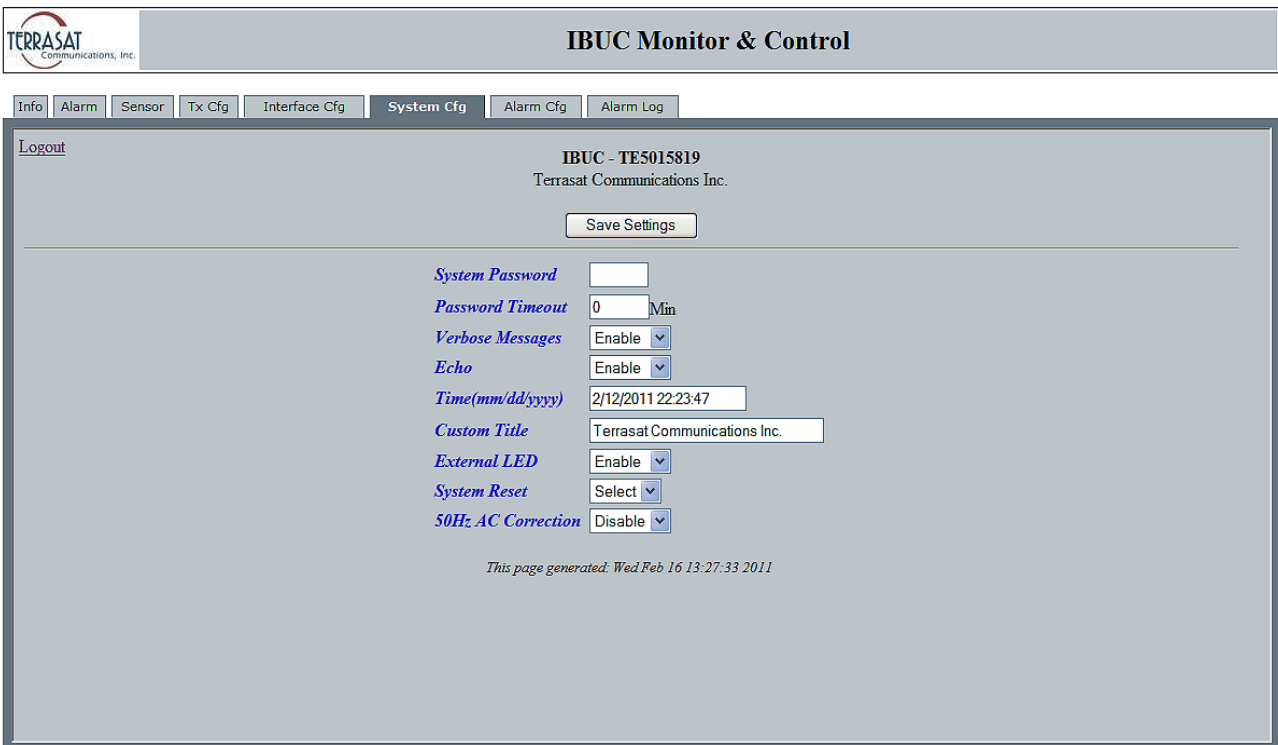

IBUC Monitor & Control

Info Alarm Sensor Tx Cfg Interface Cfg **System Cfg** Alarm Cfg Alarm Log

[Logout](#)

IBUC - TE5015819
Terrasat Communications Inc.

Save Settings

System Password

Password Timeout 0 Min

Verbose Messages Enable

Echo Enable

Time(mm/dd/yyyy) 2/12/2011 22:23:47

Custom Title Terrasat Communications Inc.

External LED Enable

System Reset Select

50Hz AC Correction Disable

This page generated: Wed Feb 16 13:27:33 2011

Figure F.11 System Configuration Tab

From this page you can configure the following parameters:

- System Password

To change the system password, type a numerical value between 1 and 65535.

Note: The default password is 1234.

- Password Timeout

Changes the time period during which you can log in to the system. Options include:

- 0 = No password timeout
- 1 to 65535 = Number of minutes before system timeout

- **Verbose Message**
Sets whether responses of the serial and TCP connections are terse (for computers to read) or verbose (for people to read).
 - Enabled = Terse
 - Disabled = Verbose
- **Echo**
Sets whether the system responds back to SET commands or remains silent. Options include:
 - Enabled
 - Disabled
- **Time**
Sets the system time of the IBUC in a mm/dd/yyyy format.
Note: If you have an older IBUC whose firmware version has been upgraded to give you the time stamp function, the system clock will reset each time the IBUC loses power. Without the capacitor that was added beginning with hardware version 1.19, there is no backup for the system clock.
- **Custom Title**
Use this 32-character alphanumeric field to create a customized label for each IBUC. Use information that will help you to identify the IBUC (such as company name, location of each IBUC, and so on).
- **External LED**
Sets the state of the multifunction LED indicator. Options include
 - Disabled (LEDs are off)
 - Enabled (LEDs are on)Enabled is the default setting.
- **System Reset**
When selected, this causes a momentary muting of the transmitter and should be used with caution. A dialog box appears and you are asked to confirm your selection.
- **50 Hz AC Correction**
When enabled, applies a 50 Hz correction factor to AC-powered IBUCs. Options include:
 - Disabled
 - EnabledDisabled is the default setting.

Note: This option is not available (that is, it does not appear on screen) for DC-powered IBUCs. It was implemented in firmware version 1.14.

Alarm Configuration Tab

Use this tab to configure alarms as Minor, Major, or None. Major alarms cause a summary alarm (relay closure) with the Form-C relay. This is particularly important when operating in redundancy mode where summary alarms will cause switchovers. You can also configure the alarms as suppressible. Suppressible alarms will be suppressed only when the “Suppress Faults” option is enabled. Click Save Settings when you have completed entering data to ensure that your changes are saved and then implemented.

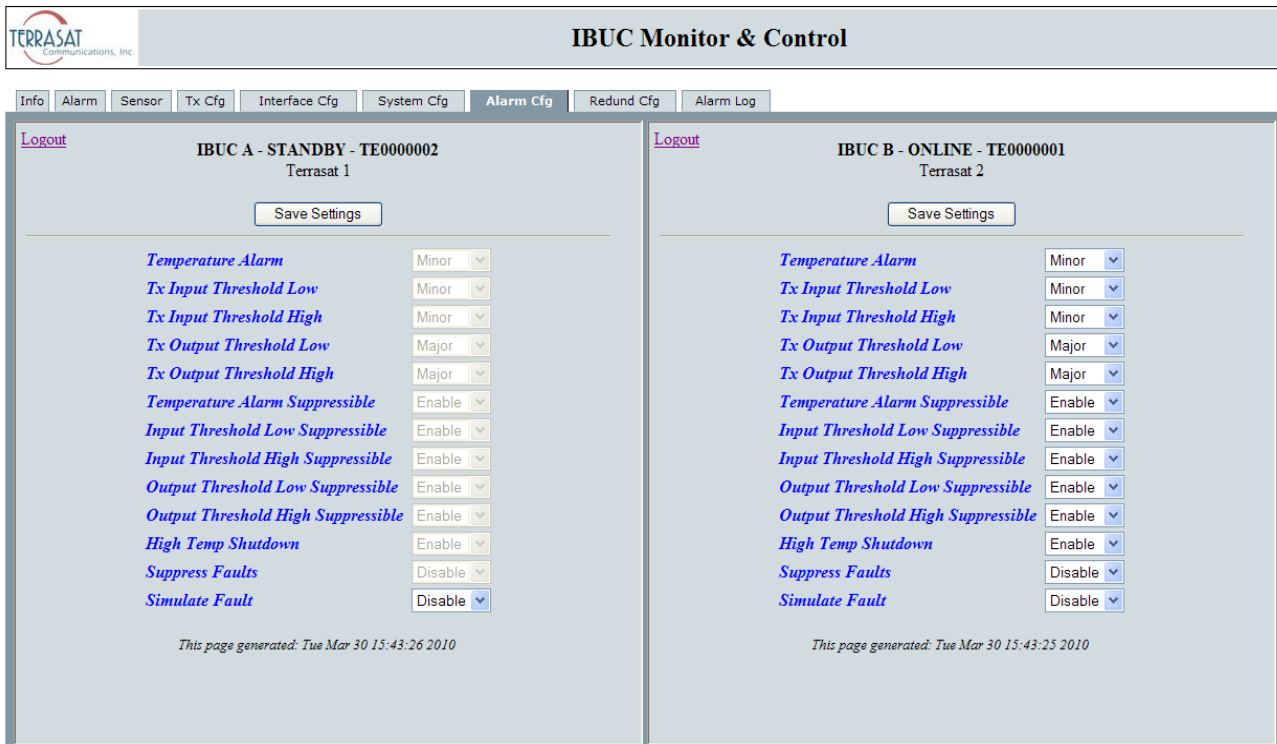

| Parameter | IBUC A - STANDBY - TE0000002 | IBUC B - ONLINE - TE0000001 |
|------------------------------------|------------------------------|-----------------------------|
| Temperature Alarm | Minor | Minor |
| Tx Input Threshold Low | Minor | Minor |
| Tx Input Threshold High | Minor | Minor |
| Tx Output Threshold Low | Major | Major |
| Tx Output Threshold High | Major | Major |
| Temperature Alarm Suppressible | Enable | Enable |
| Input Threshold Low Suppressible | Enable | Enable |
| Input Threshold High Suppressible | Enable | Enable |
| Output Threshold Low Suppressible | Enable | Enable |
| Output Threshold High Suppressible | Enable | Enable |
| High Temp Shutdown | Enable | Enable |
| Suppress Faults | Disable | Disable |
| Simulate Fault | Disable | Disable |

Figure F.12 Alarm Configuration Tab

From this page you can configure the following alarms:

- Temperature Alarm
 - Sets the type of alarm produced when the temperature threshold has been exceeded. Options include:
 - Disable
 - Minor
 - Major

- Tx Input Threshold Low
Sets the type of alarm produced when the lower Tx Input Threshold has been exceeded. Options include:
 - Disable
 - Minor
 - Major
- Tx Input Threshold High
Sets the type of alarm produced when the higher Tx Input Threshold has been exceeded. Options include:
 - Disable
 - Minor
 - Major
- Tx Output Threshold Low
Sets the type of alarm produced when the lower Tx Input Threshold has been exceeded. The default lower threshold is equal to rated P1dB - 20.
Options include:
 - Disable
 - Minor
 - Major
- Tx Output Threshold High
Sets the type of alarm produced when the higher Tx Input Threshold has been exceeded. The default higher threshold is equal to rated P1dB+ 1.
Options include:
 - Disable
 - Minor
 - Major
- Temperature Alarm Suppressible
Sets whether the temperature alarm is suppressible. When suppressed (enabled), a temperature alarm will not appear as an event in the Alarm Log. Options include:
 - Disable
 - Enable

- **Input Threshold Low Suppressible**
Sets whether the lower input threshold is suppressible. Options include:
 - Disable
 - Enable
- **Output Threshold Low Suppressible**
Sets whether the lower output threshold is suppressible. Options include:
 - Disable
 - Enable
- **Output Threshold High Suppressible**
Sets whether the higher output threshold is suppressible. Options include:
 - Disable
 - Enable
- **High Temperature Shutdown**
Sets whether to shutdown the IBUC when the internal temperature threshold of 85 °C has been exceeded. The unit must cool down by 20 °C before resuming transmission. Transmission will resume automatically once the unit has cooled by 20 °C. Options include:
 - Disable
 - Enable (default)
- **Suppress faults**
Sets whether the unit will suppress all alarms that are configured as suppressible. Options include:
 - Disable
 - Enable
- **Simulate faults**
When enabled, a simulated alarm is issued that does not affect transmission status or traffic. Options include:
 - Disable
 - Enable

Use this alarm to determine whether your alarm settings are functional. It is most useful for redundant systems to test whether a major alarm will successfully trigger a switchover to the standby unit.

Redundancy Configuration Tab

Use this tab to configure redundancy settings for a protected pair of IBUCs. Only the online IBUC can control the redundancy mode, redundancy switching type, and auto clone settings. The set IBUC location, set online IBUC, and other IBUC IP address are set individually. Click Save Settings when you have completed entering data to ensure that your changes are saved and then implemented.

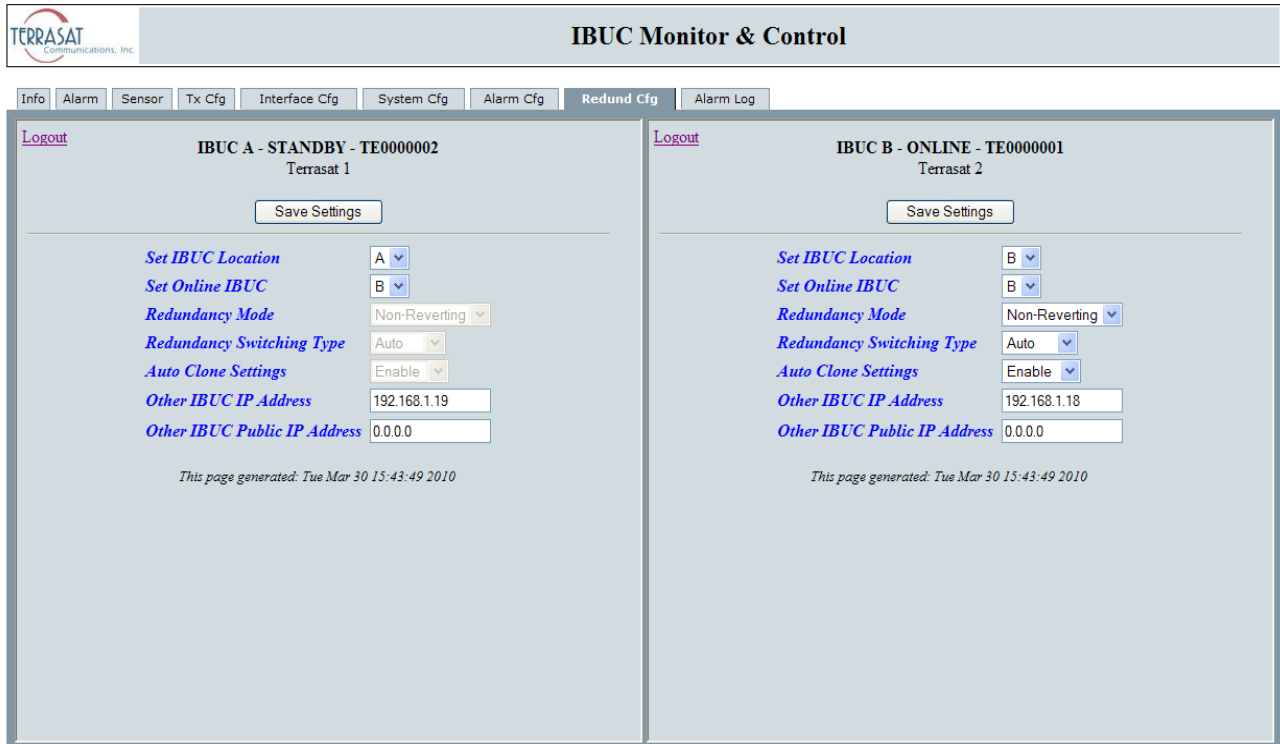

The screenshot displays the 'IBUC Monitor & Control' interface with the 'Redund Cfg' tab selected. It shows two panels for configuring IBUC A and IBUC B. Each panel includes a 'Logout' link, a 'Save Settings' button, and several configuration options:

- IBUC A - STANDBY - TE0000002 (Terrasat 1):**
 - Set IBUC Location: A
 - Set Online IBUC: B
 - Redundancy Mode: Non-Reverting
 - Redundancy Switching Type: Auto
 - Auto Clone Settings: Enable
 - Other IBUC IP Address: 192.168.1.19
 - Other IBUC Public IP Address: 0.0.0.0
- IBUC B - ONLINE - TE0000001 (Terrasat 2):**
 - Set IBUC Location: B
 - Set Online IBUC: B
 - Redundancy Mode: Non-Reverting
 - Redundancy Switching Type: Auto
 - Auto Clone Settings: Enable
 - Other IBUC IP Address: 192.168.1.18
 - Other IBUC Public IP Address: 0.0.0.0

Both panels include a footer note: 'This page generated: Tue Mar 30 15:43:49 2010'.

Figure F.13 Redundancy Configuration Tab

From this page you can configure the following parameters:

- Set IBUC Location
 - Specifies the physical location of each IBUC on the switch. In a redundant system, there must be an A: side IBUC and an B: side IBUC (not two A: side IBUCs nor two B: side IBUCs). Options include:
 - A
 - B
- Set Online IBUC
 - Specifies which IBUC is online. Options include:
 - A

- B
 - Redundancy Mode

Sets the redundancy switching mode of operation. When configured for reverting, the units can switch between each other multiple times when a fault occurs unless both units are faulted. In nonreverting mode, when the A: side unit faults, a switch to the B: side unit will occur. However, once operation has switched to the B: side unit no additional switches will occur without user intervention. This item can be changed only from the unit designated as Online (Master). Options include:

 - Reverting
 - Nonreverting
 - Redundancy Switching Type

Sets the switching type. Options include

 - Automatic
 - Manual
- Note: In Automatic Mode, if the standby unit is faulty, the online IBUC will not switch to the standby unit. However, you can force this switch when in Manual Mode.
- Auto Clone Settings

Sets the cloning configuration of a redundant pair. When enabled, the settings that are common to both units are copied from the online IBUC to the standby IBUC. Options include:

 - Enable
 - Disable
 - Other IBUC IP Address

Sets the IP address of the other IBUC.
 - Other IBUC Public IP Address

Sets the public IP address of the other IBUC. Use this option when the IBUCs are on a network and you need remote access.

Alarm Log Tab

Use this tab to view the alarm history of the IBUC. When a fault occurs, an entry is added to the alarm log. Entries are time-stamped to determine the order in which the alarms occurred. These events can be used to help determine cause during system troubleshooting.

A total of 40 events are stored by the IBUC. An event can contain multiple alarms. In [Figure F.14](#), the events recorded consist of miscellaneous (M) and transmit (T) alarms. The most recent alarm is the last in the list.

To clear the alarm history, click Clear.

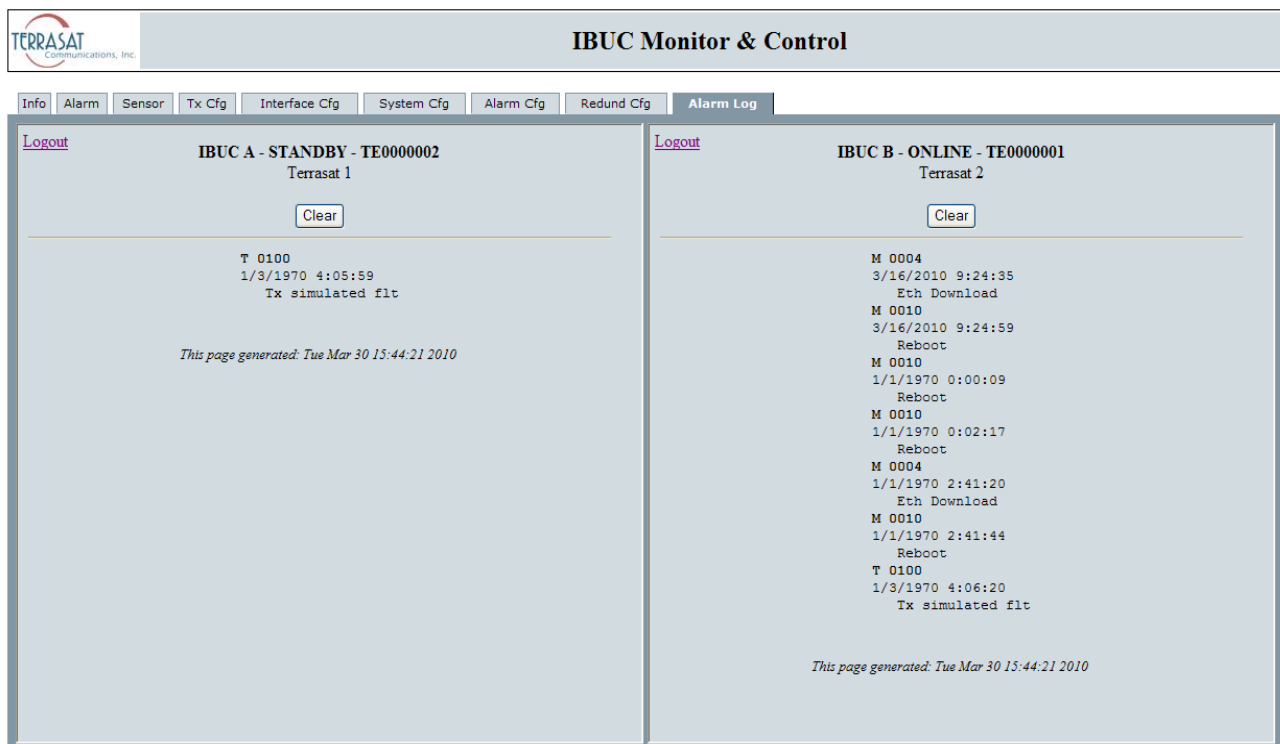

The screenshot displays the 'IBUC Monitor & Control' interface with the 'Alarm Log' tab selected. The interface is split into two panels for 'IBUC A - STANDBY - TE0000002' and 'IBUC B - ONLINE - TE0000001'. Each panel has a 'Logout' link and a 'Clear' button. The alarm log for IBUC A shows a single transmit (T) alarm: 'T 0100 1/3/1970 4:05:59 Tx simulated flt'. The alarm log for IBUC B shows a sequence of events: 'M 0004 3/16/2010 9:24:35 Eth Download', 'M 0010 3/16/2010 9:24:59 Reboot', 'M 0010 1/1/1970 0:00:09 Reboot', 'M 0010 1/1/1970 0:02:17 Reboot', 'M 0004 1/1/1970 2:41:20 Eth Download', 'M 0010 1/1/1970 2:41:44 Reboot', and 'T 0100 1/3/1970 4:06:20 Tx simulated flt'. Both panels include a footer: 'This page generated: Tue Mar 30 15:44:21 2010'.

Figure F.14 Alarm Log Tab

Note: The Alarm Log updates every minute but the information displayed updates only when there is a change from no alarms to an alarm.

This page intentionally left blank
for double-sided printing.

G

COMPONENT SPECIFICATIONS AND REFERENCE DRAWINGS

This chapter contains component specifications and outline drawings for the Terrasat Communications, Inc. line of C-band, X-band, Ku-band, and DBS-band intelligent block upconverters (IBUCs), power supply units (PSUIs), low-noise block converters (LNBS), associated interface units (IFUs, Tx 1+1, and Rx 1+1) and accessories supplied with IBUC systems.

Reference Drawings

Outline drawings are subject to change without notice. To ensure that the latest information is available, contact Terrasat.

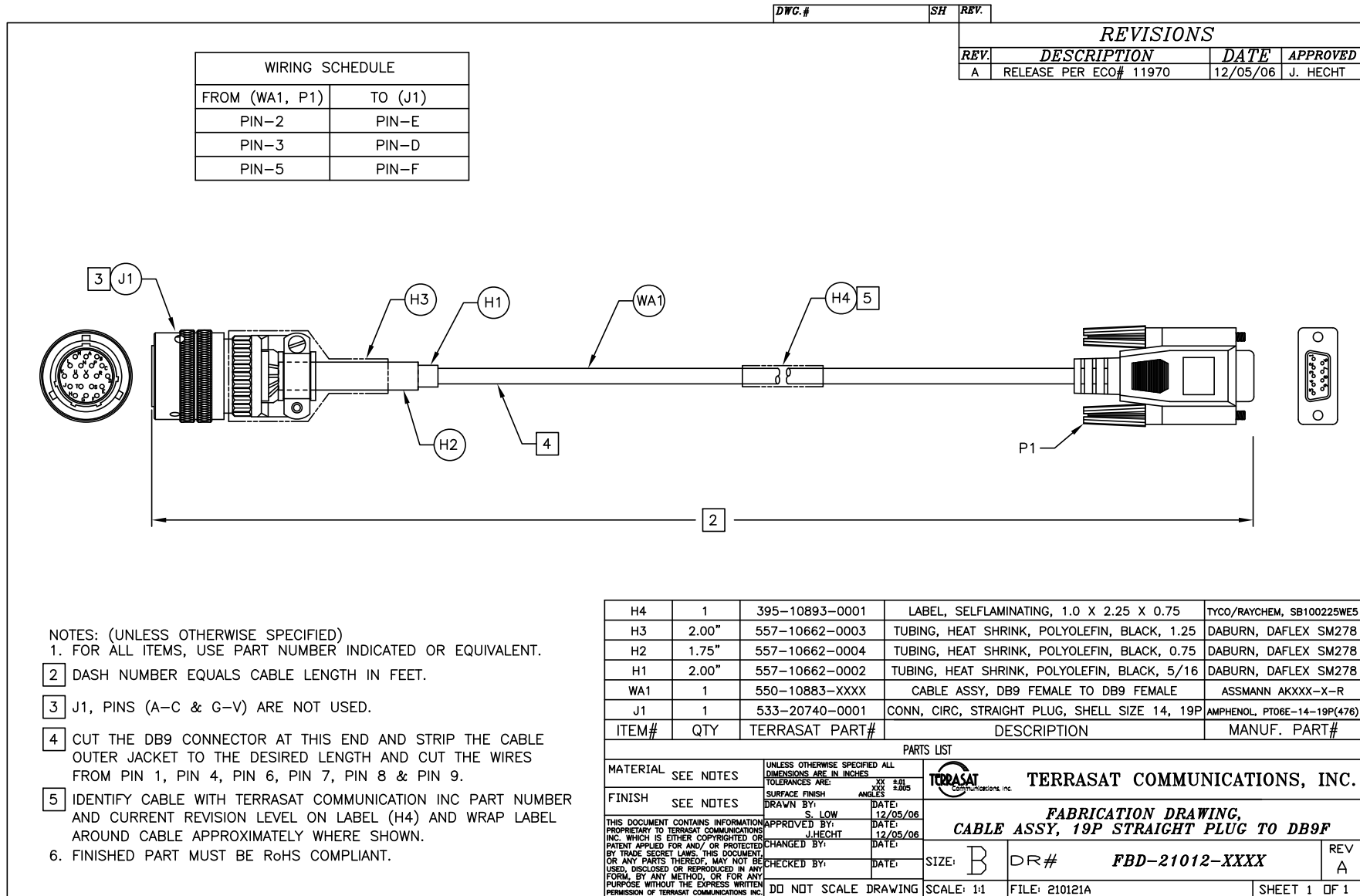

Figure G.1 Fabrication Drawing, FBD-21012-XXXX, Rev A

DWG.# SH REV.

| REVISIONS | | | |
|-----------|-------------------------|---------|----------|
| REV. | DESCRIPTION | DATE | APPROVED |
| A | RELEASED PER ECO# 11882 | 4/22/08 | J. HECHT |

- NOTES: (UNLESS OTHERWISE SPECIFIED)
- FOR ALL ITEMS, USE PART NUMBER INDICATED OR EQUIVALENT.
 - DASH NUMBER EQUALS CABLE LENGTH IN FEET.
 - J1, PINS (A-F & L-V) ARE NOT USED.
 - CUT THE RJ45 CONNECTOR AT THIS END AND STRIP THE CABLE OUTER JACKET TO THE DESIRE LENGTH AND CUT THE BLUE WHITE/BLUE, WHITE/BROWN AND BROWN WIRES.
 - IDENTIFY CABLE WITH TERRASAT PART NUMBER AND CURRENT REVISION LEVEL ON LABEL'S PRINTABLE AREA.

- FOR -0XXX CABLE, MARK WITH "ETHERNET STRAIGHT" ON LABEL'S PRINTABLE AREA.
FOR -1XXX CABLE, MARK WITH "ETHERNET CROSSOVER" ON LABEL'S PRINTABLE AREA.
- FINISHED PART MUST BE RoHS COMPLIANT.

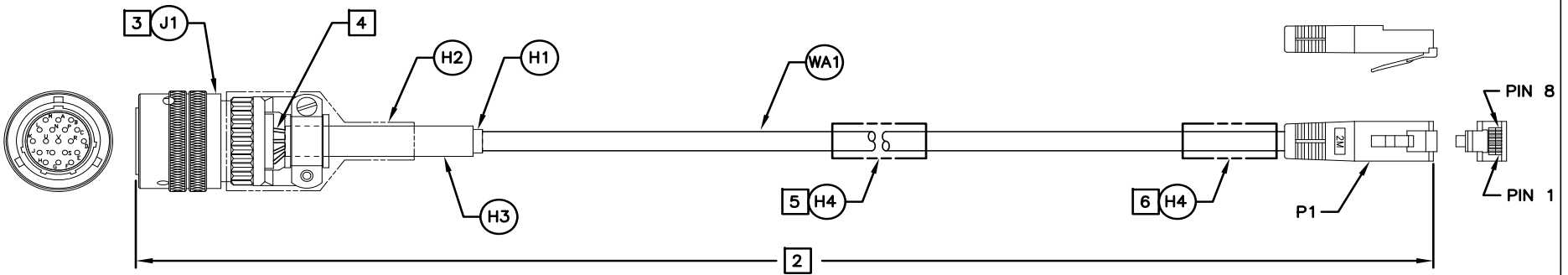

| WIRING SCHEDULE (-0XXX, STRAIGHT CONNECT) | | |
|--|---------|-------|
| WIRE | FROM P1 | TO J1 |
| WHT/ORG | PIN-1 | PIN-G |
| ORG | PIN-2 | PIN-H |
| WHT/GRN | PIN-3 | PIN-J |
| GRN | PIN-6 | PIN-K |
| BLU | PIN-4 | NC |
| WHT/BLU | PIN-5 | NC |
| WHT/BRN | PIN-7 | NC |
| BRN | PIN-8 | NC |

| WIRING SCHEDULE (-1XXX, CROSS CONNECT) | | |
|---|---------|-------|
| WIRE | FROM P1 | TO J1 |
| WHT/ORG | PIN-1 | PIN-J |
| ORG | PIN-2 | PIN-K |
| WHT/GRN | PIN-3 | PIN-G |
| GRN | PIN-6 | PIN-H |
| BLU | PIN-4 | NC |
| WHT/BLU | PIN-5 | NC |
| WHT/BRN | PIN-7 | NC |
| BRN | PIN-8 | NC |

| ITEM# | QTY | TERRASAT PART# | DESCRIPTION | MANUF. PART# |
|-------|-------|----------------|---|-----------------------------|
| H3 | 4.00" | 557-10662-0004 | TUBING, HEAT SHRINK, POLYOLEFIN, BLACK, 0.75 | DABURN, DAFLEX SM278-3/4" |
| H4 | 2 | 395-10893-0001 | LABEL, SELF LAMINATING, 1.0 x 2.25 x .75 | TYCO/RAYCHEM, SB100225WE5 |
| H2 | 2.00" | 557-10662-0003 | TUBING, HEAT SHRINK, POLYOLEFIN, BLACK, 1.25 | DABURN, DAFLEX SM278-1 1/4" |
| H1 | 4.00" | 557-10662-0002 | TUBING, HEAT SHRINK, POLYOLEFIN, BLACK, 5/16" | DABURN, DAFLEX SM278-5/16" |
| WA1 | 1 | 550-10787-XXXX | CABLE ASSY,CAT5(e),RJ45,PATCH,GRAY | ASSMANN A-MCUP-80XXX |
| J1 | 1 | 533-20740-0001 | CONN, CIRC, PLUG, SHELL SIZE 14, 19P | AMPHENOL PT06E-14-19P(476) |

| PARTS LIST | | | | |
|---|--|--|--------|--------------|
| UNLESS OTHERWISE SPECIFIED DIMENSIONS ARE IN INCHES TOLERANCES ARE: XX ±.01 XXX ±.005 | | CONTRACT # | | |
| MATERIAL SEE NOTES | | TERRASAT COMMUNICATIONS, INC. | | |
| FINISH SEE NOTES | | FABRICATION DRAWING, CABLE ASSY,TCP/IP,RJ45 TO 19P PLUG | | |
| DO NOT SCALE DRAWING | | SCALE: 1:1 | REV. A | SHEET 1 OF 1 |

Figure G.2 Fabrication Drawing, FBD-20786-XXXX, Rev A

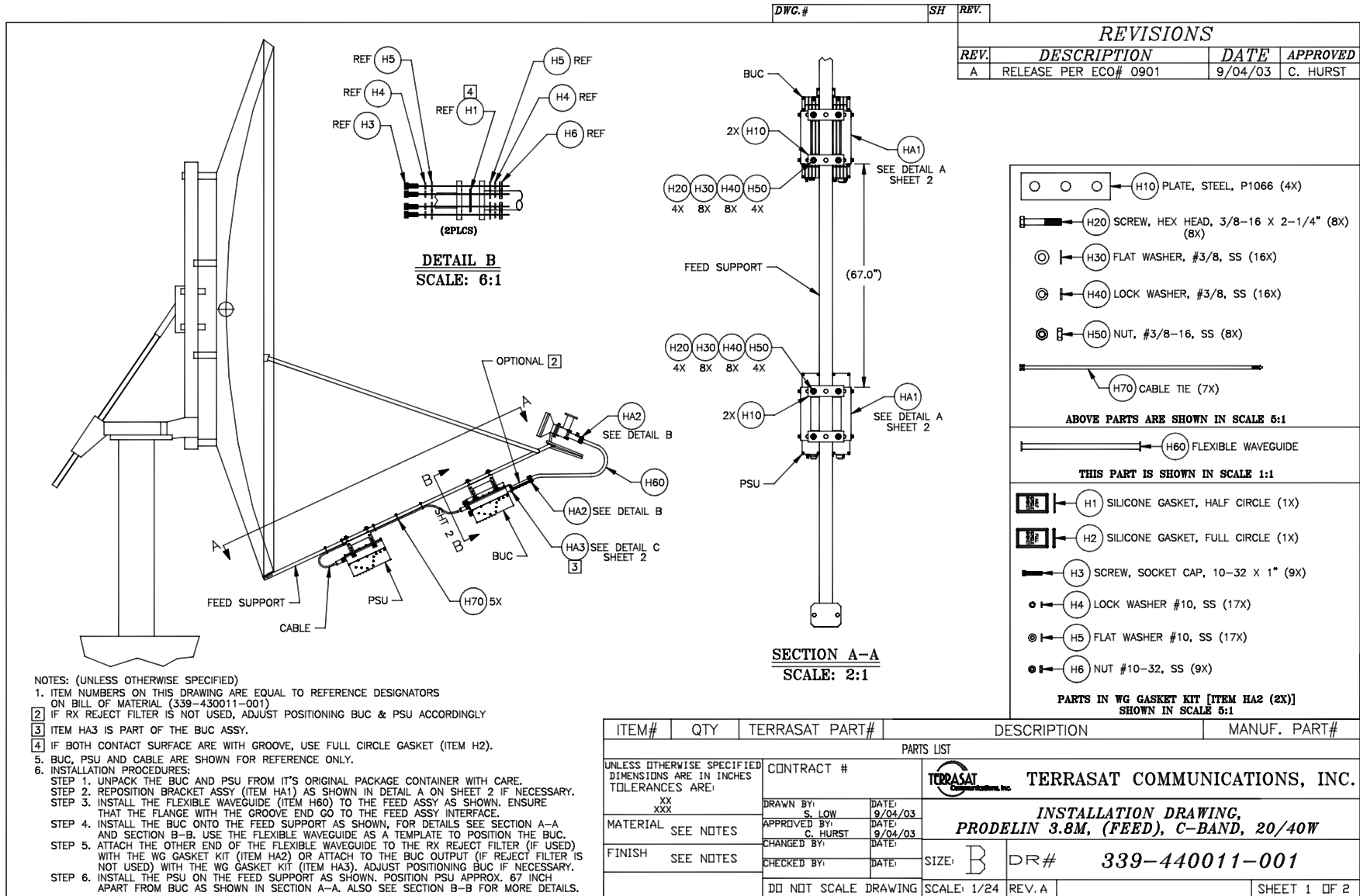

Figure G.3 Example Installation Drawing for Antenna Mounting, 339-44001-XXXX, Rev A, page 1 of 2

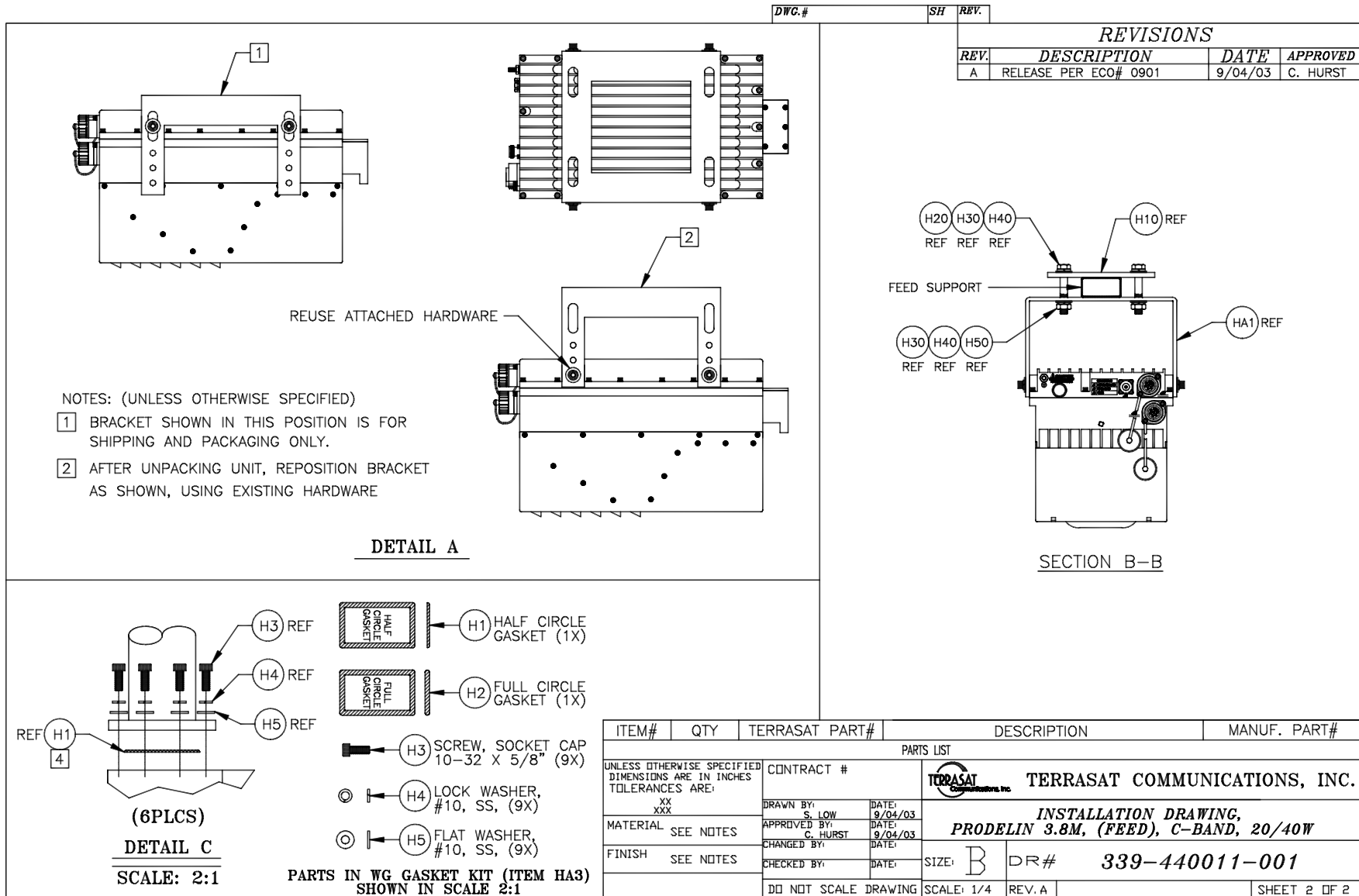

Figure G.4 Example Installation Drawing for Antenna Mounting, 339-44001-XXXX, Rev A, page 2 of 2

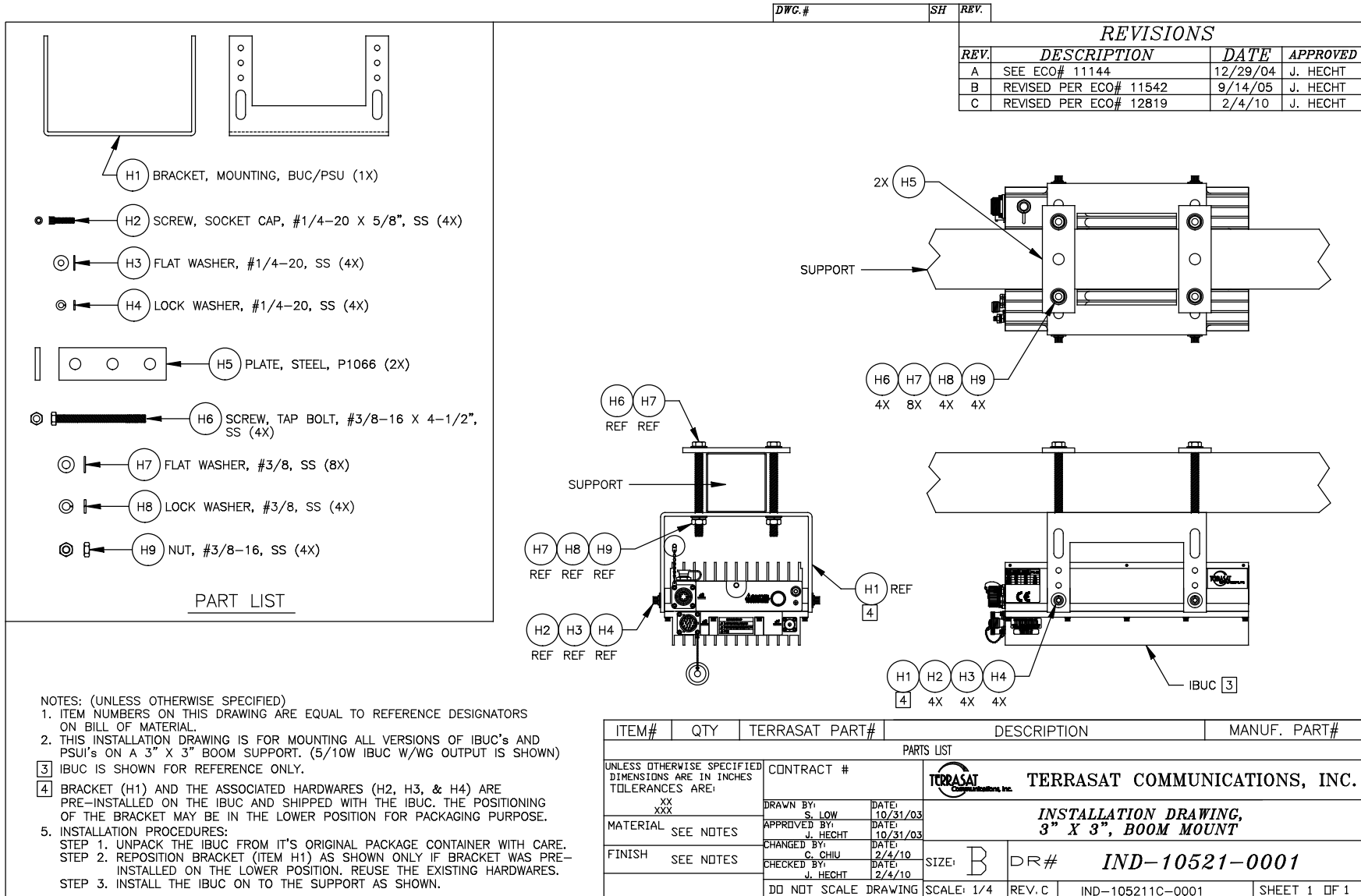

Figure G.5 Example Installation Drawing, IND-10521-0001, Rev C

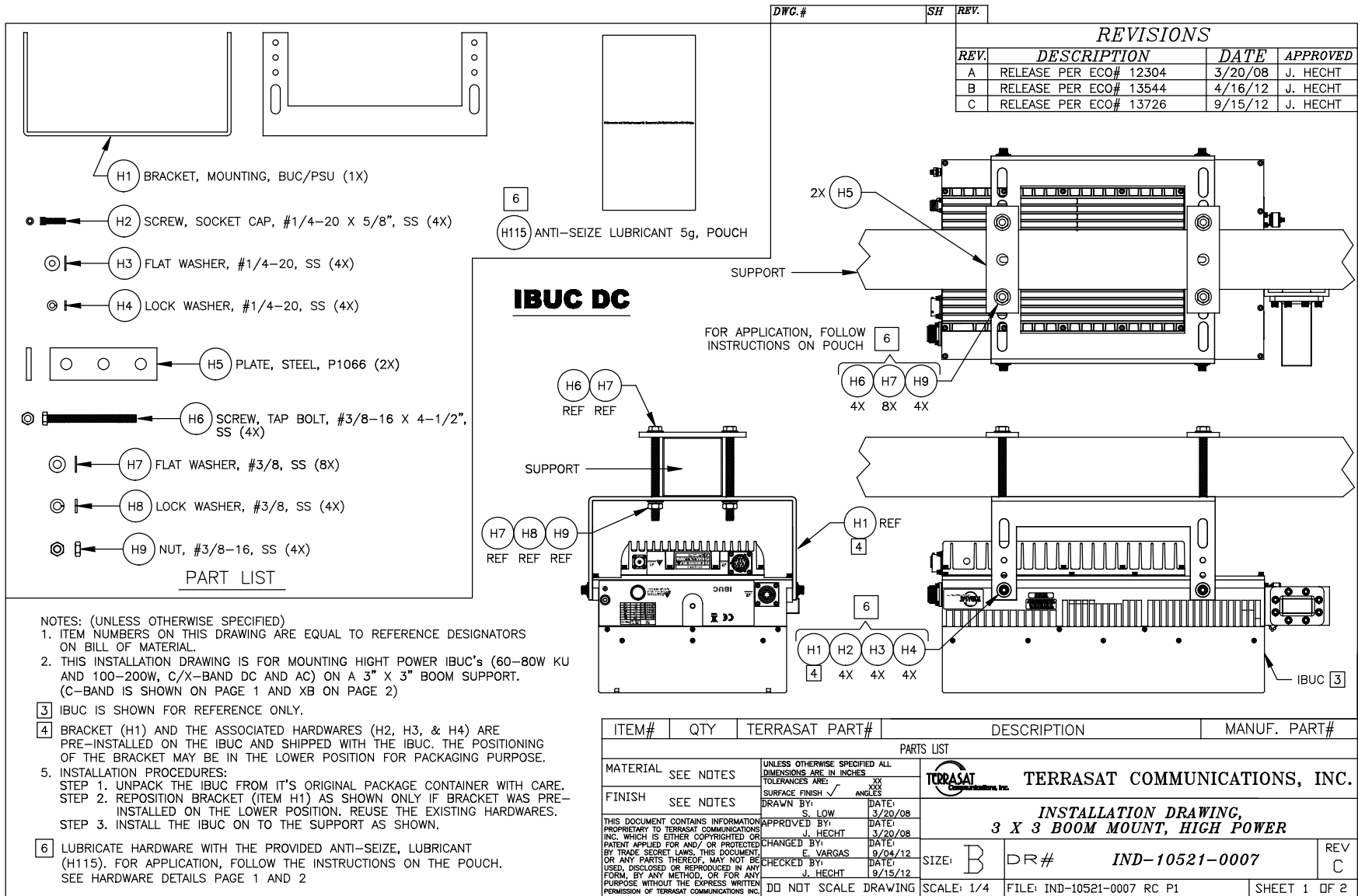

Figure G.6 Example Installation Drawing, IND-10521-0007, Rev C, page 1 of 2

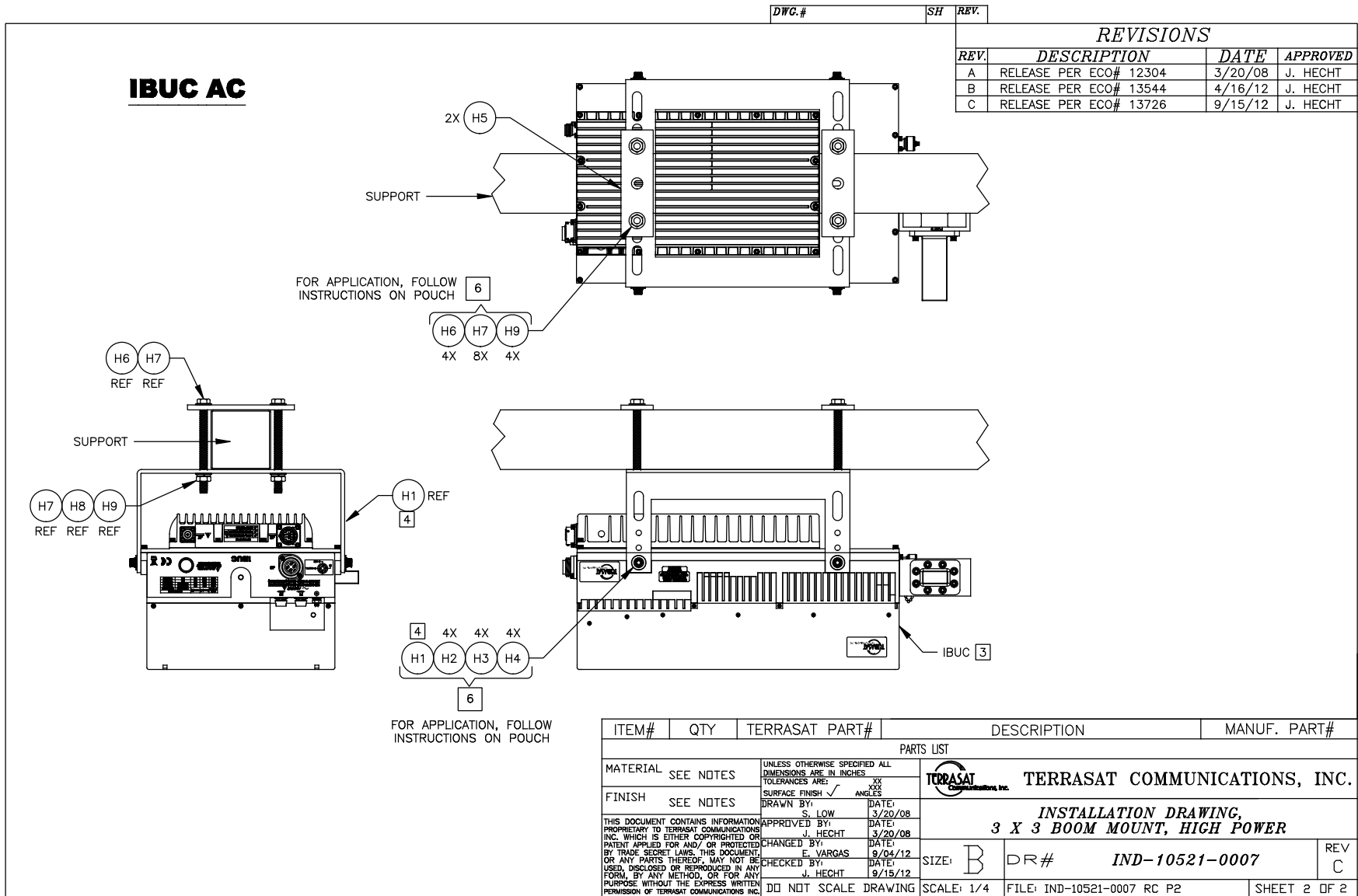

Figure G.7 Example Installation Drawing, IND-10521-0007, Rev C, page 2 of 2

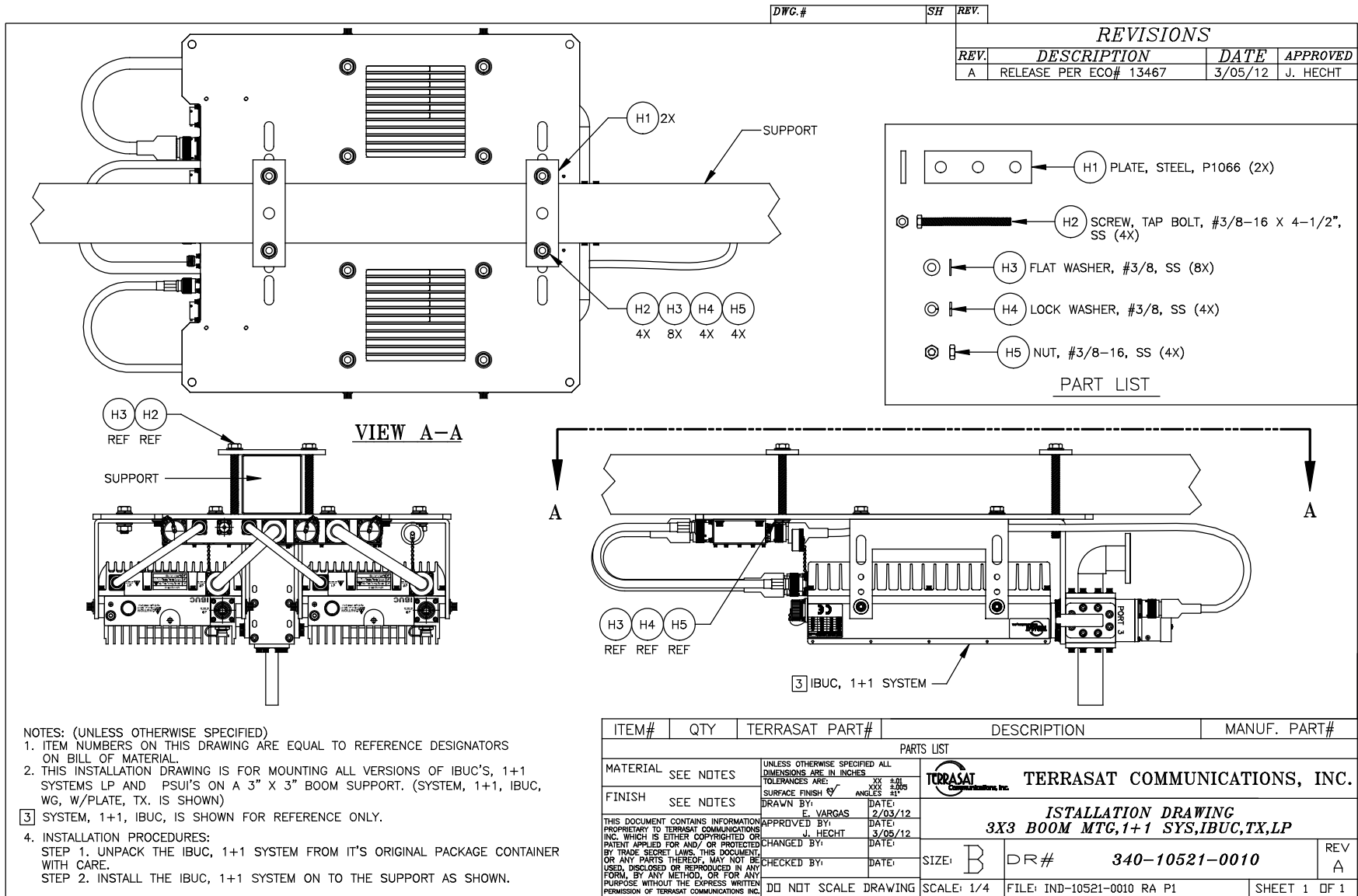

Figure G.8 Example Installation Drawing, IND-10521-0010, Rev A

Data Sheets

Refer to the datasheets in this section for detailed product information.

Product specifications are subject to change without notice. To ensure that the latest information is available, contact Terrasat.



C-Band IBUC Intelligent Block Upconverter

IBUC Advantages

Integrated BUC/SSPA for higher performance and reliability.

DC power can be supplied via IFL coax or separate DC connector for 5 W through 25 W models.

All models available with integral AC power supply or separate DC power supply.

Internal 10MHz reference option automatically switches to internal reference when external reference is not available.

Guaranteed rated output power across the entire operating temperature range and frequency band.

Low phase noise exceeds IESS308/309 requirements by a minimum of 10 dB.

Embedded Web pages provide management for small networks using any Web browser.

AGC or ALC circuits hold gain or output level constant.

16 dB User-adjustable gain in 0.1 dB steps preserves modern dynamic range.

Advanced user interfaces:

TCP/IP HTTP with embedded Web pages

- SNMP
- TELNET through TCP/IP
- FSK through TX IFL cable
- RS232/485 serial port
- Hand-held terminal



The revolutionary **IBUC** has advanced features to take your network to new heights.

IBUC offers significant benefits:

- Low terminal cost
- Simple design and installation
- Superior RF performance
- Simplified 1+1 configuration

New interfaces connect you to the **IBUC's** extensive M&C facilities for network management or local access. This powerful new M&C enables:

- **Trouble-free commissioning** with easy, point-and-click installation/configuration
- Continuous **verification** of performance with time-stamped alarm history
- Simplified **troubleshooting** of terminal faults

The **IBUC** comes with a complete set of diagnostic tools including:

- 10 MHz input detector
- Input voltage and current monitoring
- Transmit L-band input level detector
- Transmit RF output level detector
- User configurable thresholds and alarms

Unique to the **IBUC** are internal AGC and ALC functions that satisfy demanding applications with stringent specifications.

For additional information contact Terrasat Sales at +1 408-782-5911 or by Email: Sales@Terrasatinc.com.
235 Vineyard Court, Morgan Hill, CA 95037 www.terrasatinc.com

C-Band IBUC Block Upconverter

| | | | | | |
|---|--------------------------------|--|------------------------|--------------------|-------------|
| Frequency range | RF | IF | SSB Phase Noise | External reference | IBUC |
| Band 1 Std C-Band | 5850 to 6425 MHz | 950 to 1525 MHz | 10 Hz | -120 dBc/Hz | -40 dBc/Hz |
| Band 2 Palapa/ST-1 | 6425 to 6725 MHz | 975 to 1275 MHz | 100 Hz | -130 dBc/Hz | -70 dBc/Hz |
| Band 3 Insat | 6725 to 7025 MHz | 1150 to 1450 MHz | 1 kHz | -143 dBc/Hz | -80 dBc/Hz |
| Band 4 Ext. C-Band | 5850 to 6650 MHz | 950 to 1750 MHz | 10 kHz | -152 dBc/Hz | -90 dBc/Hz |
| Band 5 Full C-Band | 5850 to 6725 MHz | 975 to 1850 MHz | 100 kHz | -155 dBc/Hz | -100 dBc/Hz |
| | | | 1 MHz | -155 dBc/Hz | -110 dBc/Hz |
| VSWR / Impedance | 1.5:1 max / 50 Ohm | | | | |
| Connector | Type N female (50 Ohm) | | | | |
| Connector options | Type F (75 Ohm), TNC (50 Ohm) | | | | |
| Input power detector | -55 to -20 dBm | | | | |
| Gain | | | | | |
| Small Signal Gain (L-band to RF) with attenuator set to 0 dB | | | | | |
| 5 W | 68 dB min | | | | |
| 10 W | 71 dB min | | | | |
| 20 W | 74 dB min | | | | |
| 25 W | 75 dB min | | | | |
| 40 W | 77 dB min | | | | |
| 50 W | 78 dB min | | | | |
| 60 W | 79 dB min | | | | |
| 80 W | 80 dB min | | | | |
| Attenuator range | 16 dB variable in 0.1 dB steps | | | | |
| Gain flatness | <u>5 W to 50 W</u> | <u>60 W to 80 W & Band 4&5</u> | | | |
| Full band | 3 dB p-p max | 4 dB p-p max | | | |
| 36 MHz | 1 dB p-p max | 1 dB p-p max | | | |
| 1 MHz | 0.25 dB p-p | 0.25 dB p-p | | | |
| Gain variation over temperature | | | | | |
| Open loop | 3 dB p-p max | 4 dB p-p max | | | |
| With AGC | 1 dB p-p max | 1 dB p-p max | | | |
| RF Output | | | | | |
| Interface | CPR-137G or N-f | | | | |
| VSWR | 1.5:1 max | | | | |
| Rated output power (P1dB) | | | | | |
| 5 W | +37 dBm min | | | | |
| 10 W | +40 dBm min | | | | |
| 20 W | +43 dBm min | | | | |
| 25 W | +44 dBm min | | | | |
| 40 W | +46 dBm min | | | | |
| 50 W | +47 dBm min | | | | |
| 60 W | +47.8 dBm min | | | | |
| 80 W | +49 dBm min | | | | |
| Note: for 40 W and above, output power in bands 4 & 5 is reduced by 0.5 dB. | | | | | |
| IMD3 (2 carriers, 3 dB TOBO) | -27 dBc max | | | | |
| Level stability with ALC | ±0.5 dB | | | | |
| Output power detector range | Rated power to -20 dB | | | | |
| Power reading accuracy | ± 1.0 dB max. | | | | |
| Spurious | In Band | -70 dBc | | | |
| | Out of Band | Complies with EN 301 443 and MIL-STD 188-164 | | | |
| Harmonics | -50 dBc max. | | | | |
| Output Noise Power Density | | | | | |
| | TX < -80 dBm/Hz | | | | |
| | RX < -145 dBm/Hz | | | | |
| External Reference (multiplexed on TX IFL) | | | | | |
| Frequency | 10 MHz | | | | |
| Level | -12 to +5 dBm | | | | |
| Internal Reference - optional | | | | | |
| Local Oscillator Frequency | | | | | |
| Band 1 | 7375 MHz | | | | |
| Band 2 | 7700 MHz | | | | |
| Band 3 | 8175 MHz | | | | |
| Band 4 | 7600 MHz | | | | |
| Band 5 | 7700 MHz | | | | |
| Sense | Inverting | | | | |
| IBUC Power Supply | | | | | |
| | DC | | AC | | |
| Voltage | 48 ± 11 VDC | | 100 to 240 VAC | | |
| Option for 5 W, 10 W: | 24 ± 4 VDC | | | | |
| DC via coax available on 5 W - 25 W | | | | | |
| Power Consumption | | | | | |
| 5 W | 72 W | 85 VA | | | |
| 10 W | 96 W | 120 VA | | | |
| 20 W | 154 W | 200 VA | | | |
| 25 W | 168 W | 211 VA | | | |
| 40 W | 330 W | 363 VA | | | |
| 50 W | 360 W | 400 VA | | | |
| 60 W | 432 W | 490 VA | | | |
| 80 W | 552 W | 600 VA | | | |
| Monitor and Control | | | | | |
| FSK (multiplexed on TX IFL), RS232/485 | | | | | |
| Hand-held Terminal, TCP / IP (HTTP, Telnet, SNMP) | | | | | |
| Environmental | | | | | |
| | <u>5 W to 40 W</u> | <u>50 W to 80 W</u> | | | |
| Operating temperature | -40°C to +60°C | -40°C to +55°C | | | |
| Relative humidity | 100% condensing | | | | |
| Altitude | 10,000 ft., (3,000 m) ASL | | | | |
| Mechanical | | | | | |
| | DC powered | | AC powered | | |
| 5 W - 10 W | 12.2x7.2x4.2 in. | 12.2x7.2x4.5 in. | | | |
| | 13 lbs | 14 lbs | | | |
| 20 W - 50 W | 12.2x7.2x6.2 in. | 12.2x7.2x6.5 in. | | | |
| | 18 lbs | 19 lbs | | | |
| 60 W - 80 W | 12.2x7.2x6.7 in. | 12.2x7.2x7.0 in. | | | |
| | 18.5 lbs | 19.5 lbs | | | |

Specifications are subject to change without notice.

C-Band IBUC Data Sheet 08/06/10



235 Vineyard Court, Morgan Hill, CA 95037
Tel. +1 408-782-5911 Fax +1 408-782-5912
www.terrasatinc.com



C-Band IBUC – High Power Intelligent Block Upconverter

IBUC Advantages

Integrated BUC/SSPA for higher performance and reliability.

All models available with integral AC power supply or separate DC power supply.

Internal 10MHz reference option automatically switches to internal reference when external reference is not available.

Low phase noise exceeds IESS308/309 requirements by a minimum of 10 dB.

NMS-friendly interfaces enable remote management of your earth station RF.

Embedded Web pages provide management for small networks using any Web browser.

AGC or ALC circuits hold gain or output level constant.

16 dB User-adjustable gain in 0.1 dB steps preserves modem dynamic range.

Output sample port included on 100 W and higher power units.

Advanced user interfaces:

- TCP/IP HTTP with embedded Web pages
- SNMP
- TELNET through TCP/IP
- FSK through TX IFL cable
- RS232/485 serial port
- Hand-held terminal

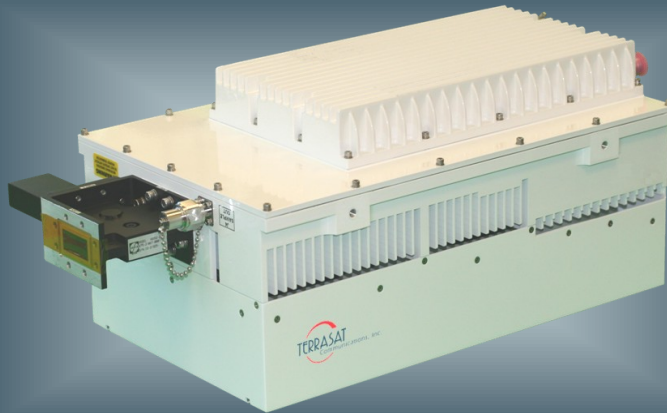

The revolutionary **IBUC** has advanced features to take your network to new heights.

IBUC offers significant benefits:

- Low terminal cost
- Simple design and installation
- Superior RF performance
- Simplified 1+1 configuration

New interfaces connect you to the **IBUC**'s extensive M&C facilities for network management or local access. This powerful new M&C enables:

- **Trouble-free commissioning** with easy, point-and-click installation/configuration
- Continuous **verification** of performance with time-stamped alarm history
- Simplified **troubleshooting** of terminal faults

The **IBUC** comes with a complete set of diagnostic tools including:

- 10 MHz input detector
- Input voltage and current monitoring
- Transmit L-band input level detector
- Transmit RF output level detector
- User configurable thresholds and alarms

Unique to the **IBUC** are internal AGC and ALC functions that satisfy demanding applications with stringent specifications.

For additional information contact Terrasat Sales at +1 408-782-5911 or by Email: Sales@Terrasatinc.com.
235 Vineyard Court, Morgan Hill, CA 95037 www.terrasatinc.com

C-Band IBUC High Power Block Upconverter

| Frequency range | RF | IF | SSB Phase Noise | External reference | IBUC |
|----------------------|-------------------------------|------------------|-----------------|--------------------|-------------|
| Band 1 Std C-Band | 5850 to 6425 MHz | 950 to 1525 MHz | 10 Hz | -120 dBc/Hz | -40 dBc/Hz |
| Band 2 Palapa/ST-1 | 6425 to 6725 MHz | 975 to 1275 MHz | 100 Hz | -130 dBc/Hz | -70 dBc/Hz |
| Band 3 Insat | 6725 to 7025 MHz | 1150 to 1450 MHz | 1 kHz | -143 dBc/Hz | -80 dBc/Hz |
| Band 4 Ext. C-Band | 5850 to 6650 MHz | 950 to 1750 MHz | 10 kHz | -152 dBc/Hz | -90 dBc/Hz |
| Band 5 Full C-Band | 5850 to 6725 MHz | 975 to 1850 MHz | 100 kHz | -155 dBc/Hz | -100 dBc/Hz |
| | | | 1 MHz | -155 dBc/Hz | -110 dBc/Hz |
| VSWR / Impedance | 1.5:1 max / 50 Ohm | | | | |
| Connector | Type N female (50 Ohm) | | | | |
| Connector options | Type F (75 Ohm), TNC (50 Ohm) | | | | |
| Input power detector | -55 to -20 dBm | | | | |

Gain

Small Signal Gain (L-band to RF) with attenuator set to 0 dB

| | |
|------|-----------|
| 100W | 81 dB min |
| 125W | 82 dB min |
| 150W | 83 dB min |
| 175W | 83 dB min |
| 200W | 84 dB min |

Attenuator range 16 dB variable in 0.1 dB steps

Gain flatness

| | |
|-----------|----------------|
| Full band | 4 dB p-p max |
| 36 MHz | 1.5 dB p-p max |
| 1 MHz | 0.25 dB p-p |

Gain variation over temperature

| | |
|-----------|--------------|
| Open loop | 4 dB p-p max |
| With AGC | 1 dB p-p max |

RF Output

| | |
|-----------|-----------------|
| Interface | CPR-137G or N-f |
| VSWR | 1.5:1 max |

Rated output power (P1dB)

| | |
|-------|---------------|
| 100 W | +50 dBm min |
| 125 W | +51 dBm min |
| 150 W | +51.8 dBm min |
| 175 W | +52.4 dBm min |
| 200 W | +53 dBm min |

Note: output power in bands 4 & 5 is reduced by 0.5 dB.

| | |
|------------------------------|--|
| IMD3 (2 carriers, 3 dB TOBO) | -27 dBc max |
| Level stability with ALC | ±0.5 dB |
| Output power detector range | Rated power to -20 dB |
| Power reading accuracy | ± 1.0 dB max. |
| Spurious | In Band -70 dBc |
| | Out of Band Complies with EN 301 443 and MIL-STD 188-164 |
| Harmonics | -50 dBc max. |
| Output Noise Power Density | |
| | TX < -76 dBm/Hz |
| | RX < -145 dBm/Hz |

External Reference (multiplexed on TX IFL)

| | |
|-------------------------------|---------------|
| Frequency | 10 MHz |
| Level | -12 to +5 dBm |
| Internal Reference - optional | |

Local Oscillator Frequency

| | |
|--------|-----------|
| Band 1 | 7375 MHz |
| Band 2 | 7700 MHz |
| Band 3 | 8175 MHz |
| Band 4 | 7600 MHz |
| Band 5 | 7700 MHz |
| Sense | Inverting |

IBUC Power Supply

| | | | |
|---------|----|-------------------------------|--|
| Voltage | DC | ± 48 VDC, 42 V min, 60 V max | |
| | AC | 100 to 240 VAC , 100W to 125W | |
| | | 200 to 240 VAC , 150W to 200W | |

| Power Consumption | DC | AC |
|-------------------|--------|---------|
| | 100 W | 700 W |
| 125 W | 800 W | 900 VA |
| 150 W | 1056 W | 1200 VA |
| 175 W | 1100 W | 1250 VA |
| 200 W | 1150 W | 1300 VA |

Monitor and Control

FSK (multiplexed on TX IFL), **RS232/485**
Hand-held Terminal, TCP / IP (HTTP, Telnet, SNMP)

Environmental

| | |
|-----------------------|---------------------------|
| Operating temperature | -40°C to +55°C |
| Relative humidity | 100% condensing |
| Altitude | 10,000 ft., (3,000 m) ASL |

Mechanical

| | |
|--------|--|
| Size | 19.5x10x7.8 in. 495x254x198 mm |
| Weight | 32 lbs, 14.5 kg DC powered 33 lbs, 15 kg AC powered |

Specifications are subject to change without notice.

C-Band Hi Power IBUC Data Sheet 10/19/10



235 Vineyard Court, Morgan Hill, CA 95037
 Tel. +1 408-782-5911 Fax +1 408-782-5912
 www.terrasatinc.com



X-Band IBUC Intelligent Block Upconverter

IBUC Advantages

Integrated BUC/SSPA for higher performance and reliability.

DC power can be supplied via IFL coax or separate DC connector for 5 W through 20 W models.

All models available with integral AC power supply or separate DC power supply.

Internal 10MHz reference option automatically switches to internal reference when external reference is not available.

Guaranteed rated output power across the entire operating temperature range and frequency band.

Embedded Web pages provide management for small networks using any Web browser.

AGC or ALC circuits hold gain or output level constant.

Customer-selectable gain makes it possible to compensate for cable and terminal losses.

Advanced user interfaces:

- TCP/IP HTTP with embedded Web pages
- SNMP
- TELNET through TCP/IP
- FSK through TX IFL cable
- RS232/485 serial port
- Hand-held terminal



The revolutionary **IBUC** has advanced features to take your network to new heights.

IBUC offers significant benefits:

- Low terminal cost
- Simple design and installation
- Superior RF performance
- Simplified 1+1 configuration

New interfaces connect you to the **IBUC**'s extensive M&C facilities for network management or local access. This powerful new M&C enables:

- **Trouble-free commissioning** with easy, point-and-click installation/configuration
- Continuous **verification** of performance with time-stamped alarm history
- Simplified **troubleshooting** of terminal faults

The **IBUC** comes with a complete set of diagnostic tools including:

- 10 MHz input detector
- Input voltage and current monitoring
- Transmit L-band input level detector
- Transmit RF output level detector
- User configurable thresholds and alarms

Unique to the **IBUC** are internal AGC and ALC functions that satisfy demanding applications with stringent specifications.

For additional information contact Terrasat Sales at +1 408-782-5911 or by Email: Sales@Terrasatinc.com.
235 Vineyard Court, Morgan Hill, CA 95037 www.terrasatinc.com

X-Band IBUC Block Upconverter

| | | | |
|--|--------------------------------|-------------------------------|---|
| Frequency range | RF 7900 to 8400 MHz | IF 950 to 1450 MHz | Group Delay Linear 0.03 ns/MHz Parabolic 0.003 ns/MHz ² Ripple 1 ns p-p over any 36 MHz |
| VSWR / Impedance | 1.5:1 max / 50 Ohm | | SSB Phase Noise External reference IBUC |
| Connector | Type N female (50 Ohm) | | |
| Connector options | Type F (75 Ohm), TNC (50 Ohm) | | |
| Input power detector | -55 to -20 dBm | | 10 Hz -120 dBc/Hz -40 dBc/Hz |
| Gain | | | |
| Small Signal Gain (L-band to RF) with attenuator set to 0 dB | | | |
| 5 W | 68 dB min | | 100 Hz -130 dBc/Hz -70 dBc/Hz |
| 10 W | 71 dB min | | 1 kHz -143 dBc/Hz -80 dBc/Hz |
| 20 W | 74 dB min | | 10 kHz -152 dBc/Hz -90 dBc/Hz |
| 25 W | 75 dB min | | 100 kHz -155 dBc/Hz -100 dBc/Hz |
| 40 W | 77 dB min | | 1 MHz -155 dBc/Hz -110 dBc/Hz |
| 50 W | 78 dB min | | External Reference (multiplexed on TX IFL) Frequency 10 MHz Level -12 to +5 dBm Internal Reference - optional |
| 60 W | 79 dB min | | |
| 80 W | 80 dB min | | |
| Attenuator range | 16 dB variable in 0.1 dB steps | | Local Oscillator Frequency 6950 MHz Sense Non-inverting |
| Gain flatness | <u>5 W to 50 W</u> | <u>60 W to 80 W</u> | |
| Full band | 3 dB p-p max | 4 dB p-p max | |
| 36 MHz | 1 dB p-p max | 1 dB p-p max | IBUC Power Supply DC AC Voltage 48 ± 11 VDC 100 to 240 VAC Option for 5 W, 10 W: 24 ± 4 VDC DC via coax available on 5 W - 20 W |
| 1 MHz | 0.25 dB p-p | 0.25 dB p-p | |
| Gain variation over temperature | | | |
| Open loop | 3 dB p-p max | 4 dB p-p max | Power Consumption 5 W 72 W 85 VA 10 W 110 W 135 VA 20 W 168 W 200 VA 25 W 192 W 225 VA 40 W 350 W 400 VA 50 W 432 W 485 VA 60 W 450 W 530 VA 80 W 576 W 656 VA |
| With AGC | 1 dB p-p max | 1 dB p-p max | |
| Noise Figure | 10 dB max. at min. attenuation | | |
| RF Output | | | |
| Interface | CPR-112G | | |
| VSWR | 1.5:1 max | | |
| Rated output power (P1dB) | | | |
| 5 W | +37 dBm min | | |
| 10 W | +40 dBm min | | |
| 20 W | +43 dBm min | | |
| 25 W | +44 dBm min | | |
| 40 W | +46 dBm min | | |
| 50 W | +47 dBm min | | |
| 60 W | +47.8 dBm min | | |
| 80 W | +49 dBm min | | |
| IMD3 (2 carriers, 3 dB TOBO) | -27 dBc max | | |
| Level stability with ALC | ±0.5 dB | | |
| Output power detector range | Rated power to -20 dB | | |
| Power reading accuracy | ± 1.0 dB max. | | |
| Spurious | In band | -65 dBc | |
| | Out of band | Complies with MIL-STD 188-164 | |
| Harmonics | -50 dBc max. | | |
| Output Noise Power Density | | | |
| TX Band | < -80 dBm/Hz | | |
| RX Band (with RX reject filter) | < -170 dBm/Hz | | |
| RX Band (w/o RX reject filter) | < -80 dBm/Hz | | |
| Mute | -70 dBc max. | | |
| AM-PM Conversion | < 3.0 deg/dB @ rated power | | |
| | | | Monitor and Control FSK (multiplexed on TX IFL), RS232/485 Hand-held Terminal, TCP / IP (HTTP, Telnet, SNMP) |
| | | | Environmental <u>5 W to 40 W</u> <u>50 W to 80 W</u> Operating temperature -40°C to +60°C -40°C to +55°C Relative humidity 100% condensing Altitude 10,000 ft., (3,000 m) ASL |
| | | | Mechanical DC powered AC powered 5 W - 10 W 12.2x7.2x4.2 in. 12.2x7.2x4.5 in. 13 lbs 14 lbs 20 W - 40 W 12.2x7.2x6.2 in. 12.2x7.2x6.5 in. 18 lbs 19 lbs 50 W - 80 W 12.2x7.2x6.7 in. 12.2x7.2x7.0 in. 18.5 lbs 19.5 lbs |

Specifications are subject to change without notice.

X-Band IBUC Data Sheet 08/06/10



235 Vineyard Court, Morgan Hill, CA 95037
Tel. +1 408-782-5911 Fax +1 408-782-5912
www.terrasatinc.com



X-Band IBUC – High Power Intelligent Block Upconverter

IBUC Advantages

Integrated BUC/SSPA for higher performance and reliability.

All models available with integral AC power supply or separate DC power supply.

Internal 10MHz reference option automatically switches to internal reference when external reference is not available.

NMS-friendly interfaces enable remote management of your earth station RF.

Embedded Web pages provide management for small networks using any Web browser.

AGC or ALC circuits hold gain or output level constant.

16 dB User-adjustable gain in 0.1 dB steps preserves modem dynamic range.

Output sample port included.

Advanced user interfaces:

- TCP/IP HTTP with embedded Web pages
- SNMP
- TELNET through TCP/IP
- FSK through TX IFL cable
- RS232/485 serial port
- Hand-held terminal

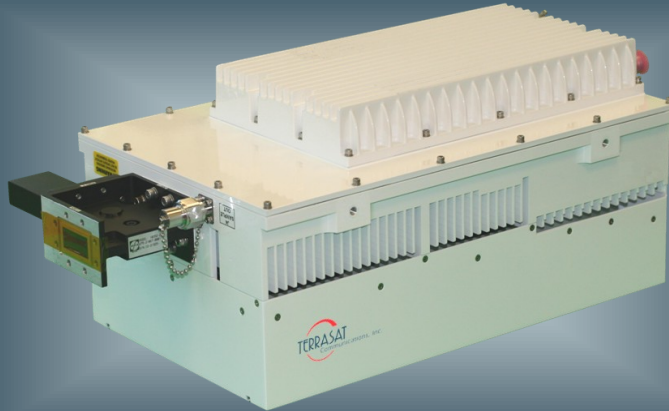

The revolutionary **IBUC** has advanced features to take your network to new heights.

IBUC offers significant benefits:

- Low terminal cost
- Simple design and installation
- Superior RF performance
- Simplified 1+1 configuration

New interfaces connect you to the **IBUC**'s extensive M&C facilities for network management or local access. This powerful new M&C enables:

- **Trouble-free commissioning** with easy, point-and-click installation/configuration
- Continuous **verification** of performance with time-stamped alarm history
- Simplified **troubleshooting** of terminal faults

The **IBUC** comes with a complete set of diagnostic tools including:

- 10 MHz input detector
- Input voltage and current monitoring
- Transmit L-band input level detector
- Transmit RF output level detector
- User configurable thresholds and alarms

Unique to the **IBUC** are internal AGC and ALC functions that satisfy demanding applications with stringent specifications.

For additional information contact Terrasat Sales at +1 408-782-5911 or by Email: Sales@Terrasatinc.com.
235 Vineyard Court, Morgan Hill, CA 95037 www.terrasatinc.com

X-Band IBUC High Power Block Upconverter

| | | | | | |
|--|---------------------------------|-------------------------------|--|---------------------------|-------------------------------|
| Frequency range | RF | IF | SSB Phase Noise | External reference | IBUC |
| | 7900 to 8400 MHz | 950 to 1450 MHz | 10 Hz | -120 dBc/Hz | -40 dBc/Hz |
| | | | 100 Hz | -130 dBc/Hz | -70 dBc/Hz |
| VSWR / Impedance | 1.5:1 max / 50 Ohm | | 1 kHz | -143 dBc/Hz | -80 dBc/Hz |
| Input Connector | Type N female (50 Ohm) | | 10 kHz | -152 dBc/Hz | -90 dBc/Hz |
| Input Connector options | Type F (75 Ohm), TNC (50 Ohm) | | 100 kHz | -155 dBc/Hz | -100 dBc/Hz |
| Input power detector range | | -55 to -20 dBm | 1 MHz | -155 dBc/Hz | -110 dBc/Hz |
| Max. input power without damage | | +10 dBm | | | |
| Gain | | | | | |
| Small Signal Gain (L-band to RF) with attenuator set to 0 dB | | | | | |
| 100 W | 81 dB min | | External Reference (multiplexed on TX IFL) | | |
| 125 W | 82 dB min | | Frequency | 10 MHz | |
| 150 W | 83 dB min | | Level | -12 to +5 dBm | |
| 175 W | 83 dB min | | Internal Reference - optional | | |
| Attenuator range | 16 dB variable in 0.1 dB steps | | Local Oscillator Frequency 6950 MHz | | |
| Gain flatness | | | Sense | Non-inverting | |
| Full band | 4 dB p-p max | | IBUC Power Supply | | |
| 36 MHz | 1.5 dB p-p max | | Voltage | DC | ±42 V min, 60 V max |
| 1 MHz | 0.25 dB p-p | | | AC | 100 to 240 VAC , 100W to 125W |
| Gain variation over temperature | | | | | 200 to 240 VAC , 150W to 175W |
| Open loop | 4 dB p-p max | | Power Consumption | DC | AC |
| With AGC | 1 dB p-p max | | 100 W | 770 W | 850 VA |
| Noise figure | 10 dB max. @ min attenuation | | 125 W | 880 W | 950 VA |
| | | | 150 W | 1100 W | 1250 VA |
| | | | 175 W | 1200 W | 1300 VA |
| RF Output | | | | | |
| Interface | CPR-112G | | Monitor and Control | | |
| VSWR | < 1.3:1 | | FSK (multiplexed on TX IFL), RS232/485 | | |
| Rated output power (P1dB) | | | Hand-held Terminal, TCP / IP (HTTP, Telnet, SNMP) | | |
| 100 W | +50 dBm min | | Environmental | | |
| 125 W | +51 dBm min | | Operating temperature | -40°C to +55°C | |
| 150 W | +51.8 dBm min | | Relative humidity | 100% condensing | |
| 175 W | +52.4 dBm min | | Altitude | 10,000 ft., (3,000 m) ASL | |
| IMD3 (2 carriers, 3 dB TOBO) | -27 dBc max | | Mechanical | | |
| Level stability with ALC | ±0.5 dB | | Size | 19.5x10x7.8 in. | |
| Output power detector range | Rated power to -20 dB | | | 495x254x198 mm | |
| Power reading accuracy | ± 1.0 dB max. | | Weight | 32 lbs, 14.5 kg | DC powered |
| Spurious | In Band | -65 dBc | | 33 lbs, 15 kg | AC powered |
| | Out of Band | Complies with MIL-STD 188-164 | | | |
| Harmonics | -50 dBc max. | | | | |
| Output Noise Power Density | | | | | |
| | TX Band | < -76 dBm/Hz | | | |
| | RX Band (with RX reject filter) | < -166 dBm/Hz | | | |
| | RX Band (w/o RX reject filter) | < -76 dBm/Hz | | | |
| Mute | -70 dBc max. | | | | |
| AM-PM Conversion | < 3.0 deg/dB @ rated power | | | | |
| Group Delay | | | | | |
| Linear | 0.03 ns/MHz | | | | |
| Parabolic | 0.003 ns/MHz ² | | | | |
| Ripple | 1 ns p-p over any 36 MHz | | | | |

Specifications are subject to change without notice.

X-Band Hi Power IBUC Data Sheet 10/28/10



235 Vineyard Court, Morgan Hill, CA 95037
Tel. +1 408-782-5911 Fax +1 408-782-5912
www.terrasatinc.com



Ku-Band IBUC Intelligent Block Upconverter

IBUC Advantages

Integrated BUC/SSPA for higher performance and reliability.

DC power can be supplied via IFL coax or separate DC connector for 4 W through 16 W models.

All models available with integral AC power supply or separate DC power supply.

Internal 10MHz reference option automatically switches to internal reference when external reference is not available.

Guaranteed rated output power across the entire operating temperature range and frequency band.

Low phase noise exceeds IESS308/309 requirements by a minimum of 5 dB.

Embedded Web pages provide management for small networks using any Web browser.

AGC or ALC circuits hold gain or output level constant.

16 dB User-adjustable gain in 0.1 dB steps preserves modem dynamic range.

Advanced user interfaces:

- TCP/IP HTTP with embedded Web pages
- SNMP
- TELNET through TCP/IP
- FSK through TX IFL cable
- RS232/485 serial port
- Hand-held terminal



The revolutionary **IBUC** has advanced features to take your network to new heights.

IBUC offers significant benefits:

- Low terminal cost
- Simple design and installation
- Superior RF performance
- Simplified 1+1 configuration

New interfaces connect you to the **IBUC's** extensive M&C facilities for network management or local access. This powerful new M&C enables:

- **Trouble-free commissioning** with easy, point-and-click installation/configuration
- Continuous **verification** of performance with time-stamped alarm history
- Simplified **troubleshooting** of terminal faults

The **IBUC** comes with a complete set of diagnostic tools including:

- 10 MHz input detector
- Input voltage and current monitoring
- Transmit L-band input level detector
- Transmit RF output level detector
- User configurable thresholds and alarms

Unique to the **IBUC** are internal AGC and ALC functions that satisfy demanding applications with stringent specifications.

For additional information contact Terrasat Sales at +1 408-782-5911 or by Email: Sales@Terrasatinc.com.
235 Vineyard Court, Morgan Hill, CA 95037 www.terrasatinc.com

Ku-Band IBUC Block Upconverter

| Frequency range | RF | IF | SSB Phase Noise | External reference | IBUC |
|-------------------------|-------------------------------|-----------------|-----------------|--------------------|-------------|
| Band 1 Std Ku | 14.00 to 14.50 GHz | 950 to 1450 MHz | 10 Hz | -120 dBc/Hz | -35 dBc/Hz |
| Band 2 Full Ku | 13.75 to 14.50 GHz | 950 to 1700 MHz | 100 Hz | -130 dBc/Hz | -65 dBc/Hz |
| Band 3 Low Ku | 12.75 to 13.25 GHz | 950 to 1450 MHz | 1 kHz | -143 dBc/Hz | -75 dBc/Hz |
| | | | 10 kHz | -152 dBc/Hz | -85 dBc/Hz |
| VSWR / Impedance | 1.5:1 max / 50 Ohm | | 100 kHz | -155 dBc/Hz | -95 dBc/Hz |
| Input Connector | Type N female (50 Ohm) | | 1 MHz | -155 dBc/Hz | -110 dBc/Hz |
| Input Connector options | Type F (75 Ohm), TNC (50 Ohm) | | | | |
| Input power detector | -55 to -20 dBm | | | | |

Gain

Small Signal Gain (L-band to RF) with attenuator set to 0 dB

| | | |
|------|-----------|--|
| 4 W | 67 dB min | |
| 8 W | 70 dB min | |
| 12 W | 72 dB min | |
| 16 W | 73 dB min | |
| 20 W | 74 dB min | |
| 25 W | 75 dB min | |
| 30 W | 76 dB min | |
| 40 W | 77 dB min | |
| 50 W | 78 dB min | |

Attenuator range 16 dB variable in 0.1 dB steps

| Gain flatness | <u>4 W to 25 W</u> | <u>30 W to 50 W</u> |
|---------------|--------------------|---------------------|
| Full band | 3 dB p-p max | 4 dB p-p max |
| 36 MHz | 1 dB p-p max | 1 dB p-p max |
| 1 MHz | 0.25 dB p-p | 0.25 dB p-p |

Gain variation over temperature

| | | |
|-----------|--------------|--------------|
| Open loop | 3 dB p-p max | 4 dB p-p max |
| With AGC | 1 dB p-p max | 1 dB p-p max |

RF Output

Interface WR75 UG cover with groove
VSWR 1.5:1 max

Rated output power (P1dB)

| | |
|------|---------------|
| 4 W | +36 dBm min |
| 8 W | +39 dBm min |
| 12 W | +40.8 dBm min |
| 16 W | +42 dBm min |
| 20 W | +43 dBm min |
| 25 W | +44 dBm min |
| 30 W | +44.8 dBm min |
| 40 W | +46 dBm min |
| 50 W | +47 dBm min |

IMD3 (2 carriers, 3 dB TOBO) -25 dBc max

Level stability with ALC ± 0.5 dB

Output power detector range Rated power to -20 dB

Power reading accuracy ± 1.0 dB max.

Spurious In Band -65 dBc

Out of Band Complies with EN 301 428 and MIL-STD 188-164

Harmonics -50 dBc max.

Output Noise Power Density

TX < -82 dBm/Hz

RX < -145 dBm/Hz

External Reference (multiplexed on TX IFL)

| | |
|-------------------------------|---------------|
| Frequency | 10 MHz |
| Level | -12 to +5 dBm |
| Internal Reference - optional | |

Local Oscillator Frequency

| | |
|--------|---------------|
| Band 1 | 13050 MHz |
| Band 2 | 12800 MHz |
| Band 3 | 11800 MHz |
| Sense | Non-Inverting |

| IBUC Power Supply | DC | AC |
|-------------------------------------|-----------------|----------------|
| Voltage | 48 \pm 11 VDC | 100 to 240 VAC |
| Option for 4 W, 8 W: | 24 \pm 4 VDC | |
| DC via coax available on 4 W - 16 W | | |

Power Consumption

| | | |
|------|-------|--------|
| 4 W | 77 W | 85 VA |
| 8 W | 110 W | 132 VA |
| 12 W | 144 W | 158 VA |
| 16 W | 168 W | 200 VA |
| 20 W | 220 W | 250 VA |
| 25 W | 270 W | 297 VA |
| 30 W | 380 W | 440 VA |
| 40 W | 400 W | 456 VA |
| 50 W | 550 W | 600 VA |

Monitor and Control

FSK (multiplexed on TX IFL), **RS232/485**

Hand-held Terminal, TCP / IP (HTTP, Telnet, SNMP)

| Environmental | <u>4 W to 25 W</u> | <u>30 W to 50 W</u> |
|-----------------------|---------------------------|---------------------|
| Operating temperature | -40°C to +60°C | -40°C to +55°C |
| Relative humidity | 100% condensing | |
| Altitude | 10,000 ft., (3,000 m) ASL | |

| Mechanical | DC powered | AC powered |
|-------------|------------------------------|------------------------------|
| 4 W - 8 W | 12.2x7.2x4.2 in. 13 lbs | 12.2x7.2x4.5 in. 14 lbs |
| 12 W - 25 W | 12.2x7.2x6.2 in. 18 lbs | 12.2x7.2x6.5 in. 19 lbs |
| 30 W - 50 W | 12.2x7.2x6.7 in. 18.5 lbs | 12.2x7.2x7.0 in. 19.5 lbs |

Specifications are subject to change without notice.

Ku-Band IBUC Data Sheet 08/06/10



235 Vineyard Court, Morgan Hill, CA 95037
Tel. +1 408-782-5911 Fax +1 408-782-5912
www.terrasatinc.com



Ku-Band IBUC - High Power Intelligent Block Upconverter

IBUC Advantages

Integrated BUC/SSPA for higher performance and reliability.

All models available with integral AC power supply or separate DC power supply.

Internal 10MHz reference option automatically switches to internal reference when external reference is not available.

Low phase noise exceeds IESS308/309 requirements by a minimum of 5 dB.

NMS-friendly interfaces enable remote management of your earth station RF.

Embedded Web pages provide management for small networks using any Web browser.

AGC or ALC circuits hold gain or output level constant.

16 dB User-adjustable gain in 0.1 dB steps preserves modem dynamic range.

Output sample port included.

Advanced user interfaces:

- TCP/IP HTTP with embedded Web pages
- SNMP
- TELNET through TCP/IP
- FSK through TX IFL cable
- RS232/485 serial port
- Hand-held terminal

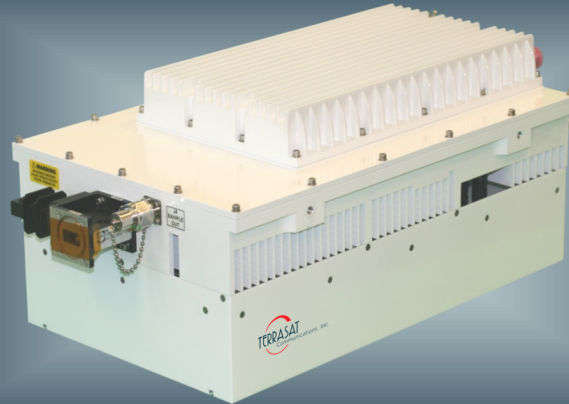

The revolutionary **IBUC** has advanced features to take your network to new heights.

IBUC offers significant benefits:

- Low terminal cost
- Simple design and installation
- Superior RF performance
- Simplified 1+1 configuration

New interfaces connect you to the **IBUC**'s extensive M&C facilities for network management or local access. This powerful new M&C enables:

- **Trouble-free commissioning** with easy, point-and-click installation/configuration
- Continuous **verification** of performance with time-stamped alarm history
- Simplified **troubleshooting** of terminal faults

The **IBUC** comes with a complete set of diagnostic tools including:

- 10 MHz input detector
- Input voltage and current monitoring
- Transmit L-band input level detector
- Transmit RF output level detector
- User configurable thresholds and alarms

Unique to the **IBUC** are internal AGC and ALC functions that satisfy demanding applications with stringent specifications.

For additional information contact Terrasat Sales at +1 408-782-5911 or by Email: Sales@Terrasatinc.com.
235 Vineyard Court, Morgan Hill, CA 95037 www.terrasatinc.com

Ku-Band IBUC High Power Block Upconverter

| Frequency range | RF | IF | SSB Phase Noise | External reference | IBUC |
|------------------------|-------------------------------|-----------------|------------------------|--------------------|-------------|
| Band 1 Std Ku | 14.00 to 14.50 GHz | 950 to 1450 MHz | 10 Hz | -120 dBc/Hz | -35 dBc/Hz |
| Band 2 Full Ku | 13.75 to 14.50 GHz | 950 to 1700 MHz | 100 Hz | -130 dBc/Hz | -65 dBc/Hz |
| Band 3 Low Ku | 12.75 to 13.25 GHz | 950 to 1450 MHz | 1 kHz | -143 dBc/Hz | -75 dBc/Hz |
| | | | 10 kHz | -152 dBc/Hz | -85 dBc/Hz |
| VSWR / Impedance | 1.5:1 max / 50 Ohm | | 100 kHz | -155 dBc/Hz | -95 dBc/Hz |
| Connector | Type N female (50 Ohm) | | 1 MHz | -155 dBc/Hz | -110 dBc/Hz |
| Connector options | Type F (75 Ohm), TNC (50 Ohm) | | | | |
| Input power detector | -55 to -20 dBm | | | | |

Gain

Small Signal Gain (L-band to RF) with attenuator set to 0 dB

60 W 79 dB min

80 W 80 dB min

Attenuator range 16 dB variable in 0.1 dB steps

Gain flatness

Full band 4 dB p-p max

36 MHz 1.5 dB p-p max

1 MHz 0.25 dB p-p

Gain variation over temperature

Open loop 4 dB p-p max

With AGC 1 dB p-p max

RF Output

Interface WR75 UG cover with groove

VSWR 1.5:1 max

Rated output power (P1dB)

60 W Band 1 & 3 +47.8 dBm min Band 2 +47.5 dBm min

80 W +49.0 dBm min +48.5 dBm min

IMD3 (2 carriers, 3 dB TOBO) -24 dBc max

Level stability with ALC ± 0.5 dB

Output power detector range Rated power to -20 dB

Power reading accuracy ± 1.0 dB max.

Spurious In Band -65 dBc

Out of Band Complies with EN 301 428 and MIL-STD 188-164

Harmonics -50 dBc max.

Output Noise Power Density

TX < -80 dBm/Hz

RX < -145 dBm/Hz

External Reference (multiplexed on TX IFL)

Frequency 10 MHz

Level -12 to +5 dBm

Internal Reference - optional

Local Oscillator Frequency

Band 1 13050 MHz

Band 2 12800 MHz

Band 3 11800 MHz

Sense Non-Inverting

IBUC Power Supply

| | DC | AC |
|---------|--------------|----------------|
| Voltage | ± 48 VDC | 100 to 240 VAC |

42 V min, 60 V max

Power Consumption

60 W 750 W 850 VA

80 W 850 W 900 VA

Monitor and Control

FSK (multiplexed on TX IFL), **RS232/485**

Hand-held Terminal, TCP / IP (HTTP, Telnet, SNMP)

Environmental

Operating temperature -40°C to +55°C

Relative humidity 100% condensing

Altitude 10,000 ft., (3,000 m) ASL

Mechanical

Size 19.5x10x7.8 in.

495x254x198 mm

Weight 32 lbs, 14.5 kg DC powered

33 lbs, 15 kg AC powered

Specifications are subject to change without notice.

Ku-Band IBUC Hi Power Data Sheet 08/06/10



235 Vineyard Court, Morgan Hill, CA 95037
Tel. +1 408-782-5911 Fax +1 408-782-5912
www.terrasatinc.com



Low Profile Ku-Band IBUC Intelligent Block Upconverter

IBUC Advantages

12 W through 50 W models available.

Low profile ideal for mounting on vehicles.

Integrated BUC/SSPA for higher performance and reliability.

Internal 10MHz reference option automatically switches to internal reference when external reference is not available.

Guaranteed rated output power across the entire operating temperature range and frequency band.

Low phase noise exceeds IESS308/309 requirements by a minimum of 5 dB.

Embedded Web pages provide management for small networks using any Web browser.

AGC or ALC circuits hold gain or output level constant.

16 dB User-adjustable gain in 0.1 dB steps preserves modern dynamic range.

Advanced user interfaces:

- TCP/IP HTTP with embedded Web pages
- SNMP
- TELNET through TCP/IP
- FSK through TX IFL cable
- RS232/485 serial port
- Hand-held terminal



The revolutionary **IBUC** has advanced features to take your network to new heights.

IBUC offers significant benefits:

- Low terminal cost
- Simple design and installation
- Superior RF performance
- Simplified 1+1 configuration

New interfaces connect you to the **IBUC**'s extensive M&C facilities for network management or local access. This powerful new M&C enables:

- **Trouble-free commissioning** with easy, point-and-click installation/configuration
- Continuous **verification** of performance with time-stamped alarm history
- Simplified **troubleshooting** of terminal faults

The **IBUC** comes with a complete set of diagnostic tools including:

- 10 MHz input detector
- Input voltage and current monitoring
- Transmit L-band input level detector
- Transmit RF output level detector
- User configurable thresholds and alarms

Unique to the **IBUC** are internal AGC and ALC functions that satisfy demanding applications with stringent specifications.

**For additional information contact Terrasat Sales at +1 408-782-5911 or by Email: Sales@Terrasatinc.com.
235 Vineyard Court, Morgan Hill, CA 95037 www.terrasatinc.com**

Low Profile Ku-Band IBUC Block Upconverter

| Frequency range | RF | IF | SSB Phase Noise | External reference | IBUC |
|----------------------|-------------------------------|-----------------|-----------------|--------------------|-------------|
| Band 1 Std Ku | 14.00 to 14.50 GHz | 950 to 1450 MHz | 10 Hz | -120 dBc/Hz | -35 dBc/Hz |
| Band 2 Full Ku | 13.75 to 14.50 GHz | 950 to 1700 MHz | 100 Hz | -130 dBc/Hz | -65 dBc/Hz |
| | | | 1 kHz | -143 dBc/Hz | -75 dBc/Hz |
| VSWR / Impedance | 1.5:1 max / 50 Ohm | | 10 kHz | -152 dBc/Hz | -85 dBc/Hz |
| Connector | Type N female (50 Ohm) | | 100 kHz | -155 dBc/Hz | -95 dBc/Hz |
| Connector options | Type F (75 Ohm), TNC (50 Ohm) | | 1 MHz | -155 dBc/Hz | -110 dBc/Hz |
| Input power detector | -55 to -20 dBm | | | | |

Gain

Small Signal Gain (L-band to RF) with attenuator set to 0 dB

| | |
|------|-----------|
| 12 W | 72 dB min |
| 16 W | 73 dB min |
| 20 W | 74 dB min |
| 25 W | 75 dB min |
| 30 W | 76 dB min |
| 40 W | 77 dB min |
| 50 W | 78 dB min |

Attenuator range 16 dB variable in 0.1 dB steps

| Gain flatness | <u>12 W to 25 W</u> | <u>30 W to 50 W</u> |
|---------------|---------------------|---------------------|
| Full band | 3 dB p-p max | 4 dB p-p max |
| 36 MHz | 1 dB p-p max | 1 dB p-p max |
| 1 MHz | 0.25 dB p-p | 0.25 dB p-p |

Gain variation over temperature

| | | |
|-----------|--------------|--------------|
| Open loop | 3 dB p-p max | 4 dB p-p max |
| With AGC | 1 dB p-p max | 1 dB p-p max |

RF Output

Interface WR75 UG cover with groove

VSWR 1.5:1 max

Rated output power (P1dB)

| | |
|------|---------------|
| 12 W | +40.8 dBm min |
| 16 W | +42 dBm min |
| 20 W | +43 dBm min |
| 25 W | +44 dBm min |
| 30 W | +44.8 dBm min |
| 40 W | +46 dBm min |
| 50 W | +47 dBm min |

IMD3 (2 carriers, 3 dB TOBO) -25 dBc max

Level stability with ALC ±0.5 dB

Output power detector range Rated power to -20 dB

Power reading accuracy ± 1.0 dB max.

Spurious In Band -65 dBc
Out of Band Complies with EN 301 428 and MIL-STD 188-164

Harmonics -50 dBc max.

Output Noise Power Density

| | |
|----|---------------|
| TX | < -82 dBm/Hz |
| RX | < -145 dBm/Hz |

External Reference (multiplexed on TX IFL)

| | |
|-------------------------------|---------------|
| Frequency | 10 MHz |
| Level | -12 to +5 dBm |
| Internal Reference - optional | |

Local Oscillator Frequency

| | |
|--------|---------------|
| Band 1 | 13050 MHz |
| Band 2 | 12800 MHz |
| Sense | Non-Inverting |

IBUC Power Supply

Voltage 48 ± 11 VDC

Power Consumption

| | |
|------|-------|
| 12 W | 144 W |
| 16 W | 168 W |
| 20 W | 220 W |
| 25 W | 270 W |
| 30 W | 380 W |
| 40 W | 400 W |
| 50 W | 550 W |

Monitor and Control

FSK (multiplexed on TX IFL), **RS232/485**

Hand-held Terminal, TCP / IP (HTTP, Telnet, SNMP)

Environmental 12 W to 25 W 30 W to 50 W

Operating temperature -40°C to +55°C -40°C to +50°C

Relative humidity 100% condensing

Altitude 10,000 ft., (3,000 m) ASL

Mechanical

| | |
|-------------------|--------|
| 16.0x14.1x2.9 in. | 26 lbs |
| 406x359x74 mm | 12 kg |

Specifications are subject to change without notice.

Low Profile Ku-Band IBUC Data Sheet 08/06/10



235 Vineyard Court, Morgan Hill, CA 95037
Tel. +1 408-782-5911 Fax +1 408-782-5912
www.terrasatinc.com



DBS-Band IBUC Intelligent Block Upconverter

IBUC Advantages

Integrated BUC/SSPA for higher performance and reliability.

DC power can be supplied via IFL coax or separate DC connector for 5 W through 8 W models.

All models available with integral AC power supply or separate DC power supply.

Internal 10MHz reference option automatically switches to internal reference when external reference is not available.

Embedded Web pages provide management for small networks using any Web browser.

AGC or ALC circuits hold gain or output level constant.

16 dB User-adjustable gain in 0.1 dB steps preserves modern dynamic range.

Advanced user interfaces:

- TCP/IP HTTP with embedded Web pages
- SNMP
- TELNET through TCP/IP
- FSK through TX IFL cable
- RS232/485 serial port
- Hand-held terminal

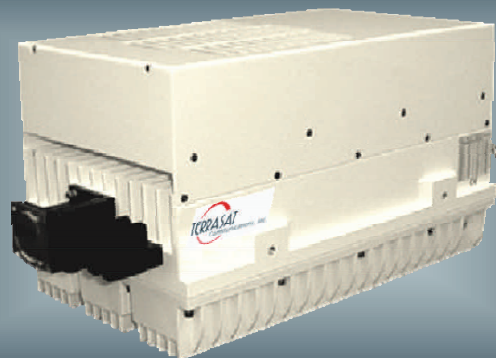

The revolutionary **IBUC** has advanced features to take your network to new heights.

IBUC offers significant benefits:

- Low terminal cost
- Simple design and installation
- Superior RF performance
- Simplified 1+1 configuration

New interfaces connect you to the **IBUC**'s extensive M&C facilities for network management or local access. This powerful new M&C enables:

- **Trouble-free commissioning** with easy, point-and-click installation/configuration
- Continuous **verification** of performance with time-stamped alarm history
- Simplified **troubleshooting** of terminal faults

The **IBUC** comes with a complete set of diagnostic tools including:

- 10 MHz input detector
- Input voltage and current monitoring
- Transmit L-band input level detector
- Transmit RF output level detector
- User configurable thresholds and alarms

Unique to the **IBUC** are internal AGC and ALC functions that satisfy demanding applications with stringent specifications.

For additional information contact Terrasat Sales at +1 408-782-5911 or by Email: Sales@Terrasatinc.com.
235 Vineyard Court, Morgan Hill, CA 95037 www.terrasatinc.com

DBS-Band IBUC Block Upconverter

| Frequency range | RF | IF | SSB Phase Noise | External reference | IBUC |
|----------------------|-------------------------------|------------------|-----------------|--------------------|-------------|
| Band 1 | 17.3 to 18.1 GHz | 950 to 1750 MHz | 10 Hz | -120 dBc/Hz | -32 dBc/Hz |
| Band 2 | 18.1 to 18.4 GHz | 1150 to 1450 MHz | 100 Hz | -130 dBc/Hz | -62 dBc/Hz |
| | | | 1 kHz | -143 dBc/Hz | -72 dBc/Hz |
| VSWR / Impedance | 1.5:1 max / 50 Ohm | | 10 kHz | -152 dBc/Hz | -82 dBc/Hz |
| Connector | Type N female (50 Ohm) | | 100 kHz | -155 dBc/Hz | -92 dBc/Hz |
| Connector options | Type F (75 Ohm), TNC (50 Ohm) | | 1 MHz | -155 dBc/Hz | -110 dBc/Hz |
| Input power detector | -55 to -20 dBm | | | | |

Gain

Small Signal Gain (L-band to RF) with attenuator set to 0 dB

| | |
|---------------------------------|--------------------------------|
| 5 W | 68 dB min |
| 8 W | 70 dB min |
| 10W | 71 dB min |
| 20 W | 74 dB min |
| 25 W | 75 dB min |
| Attenuator range | 16 dB variable in 0.1 dB steps |
| Gain flatness | |
| Full band | 3 dB p-p max |
| 36 MHz | 1 dB p-p max |
| 1 MHz | 0.25 dB p-p |
| Gain variation over temperature | |
| Open loop | 3 dB p-p max |
| With AGC | 1 dB p-p max |

RF Output

| | |
|------------------------------|---------------------------|
| Interface | WR62 UG cover with groove |
| VSWR | 1.5:1 max |
| Rated output power (P1dB) | |
| 5 W | +37 dBm min |
| 8 W | +39 dBm min |
| 10 W | +40 dBm min |
| 20 W | +43 dBm min |
| 25 W | +44 dBm min |
| IMD3 (2 carriers, 3 dB TOBO) | -23 dBc max |
| Level stability with ALC | ±0.5 dB |
| Output power detector range | Rated power to -20 dB |
| Power reading accuracy | ± 1.0 dB max. |
| Spurious In Band | -50 dBc max. |
| Harmonics | -50 dBc max. |
| Output Noise Power Density | |
| TX | < -85 dBm/Hz |
| RX | < -150 dBm/Hz |

External Reference (multiplexed on TX IFL)

| | |
|-------------------------------|---------------|
| Frequency | 10 MHz |
| Level | -12 to +5 dBm |
| Internal Reference - optional | |

Local Oscillator Frequency

| | |
|--------|---------------|
| Band 1 | 16350 MHz |
| Band 2 | 16950 MHz |
| Sense | Non-Inverting |

IBUC Power Supply

| | DC | AC |
|--------------------------------------|-------------|----------------|
| Voltage | 48 ± 11 VDC | 100 to 240 VAC |
| DC via coax available on 5 W and 8 W | | |

Power Consumption

| | | |
|------|-------|--------|
| 5 W | 95 W | 120 VA |
| 8 W | 168 W | 185 VA |
| 10 W | 192 W | 220 VA |
| 20 W | 280 W | 320 VA |
| 25 W | 310 W | 350 VA |

Monitor and Control

FSK (multiplexed on TX IFL), **RS232/485**

Hand-held Terminal, TCP / IP (HTTP, Telnet, SNMP)

Environmental

| | |
|-----------------------|---------------------------|
| Operating temperature | -40°C to +55°C |
| Relative humidity | 100% condensing |
| Altitude | 10,000 ft., (3,000 m) ASL |

Mechanical

| | DC powered | AC powered |
|------------|----------------------------|----------------------------|
| 5 W | 12.2x7.2x4.2 in. 13 lbs | 12.2x7.2x4.5 in. 14 lbs |
| 8 W - 25 W | 12.2x7.2x6.2 in. 18 lbs | 12.2x7.2x6.5 in. 19 lbs |

Specifications are subject to change without notice.

DBS-Band IBUC Data Sheet 8/16/12



235 Vineyard Court, Morgan Hill, CA 95037
Tel. +1 408-782-5911 Fax +1 408-782-5912
www.terrasatinc.com



Ka-Band IBUC 29.5-30.0 GHz Intelligent Block Upconverter

IBUC Advantages

Integrated BUC/SSPA packaging for higher performance and reliability.

All models available with integral AC power supply or separate DC power supply.

NMS-friendly interfaces enable remote management of your earth station RF.

Embedded web pages provide management for small networks using any web browser.

AGC or ALC circuits hold gain or output level constant.

30dB User-adjustable gain in 0.1 dB steps preserves modem dynamic range.

1+1 switching logic and drivers built into the IBUC eliminate expensive external switching controller.

Advanced user interfaces:

- TCP/IP HTTP with embedded web pages.
- SNMP
- TELNET through TCP/IP
- FSK through TX IFL cable.
- RS232/485 serial port.
- Handheld terminal

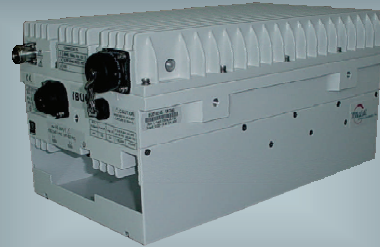

The revolutionary **IBUC** has advanced features to take your network to new heights.

IBUC offers significant benefits:

- Low terminal cost
- Simple design and installation
- Superior RF performance
- Simplified 1+1 configuration

New interfaces connect you to the **IBUC**'s extensive M&C facilities for network management or local access. This powerful new M&C enables:

- **Trouble free commissioning** with easy, point-and-click installation/configuration
- Continuous **verification** of performance with time-stamped alarm history.
- Simplified **troubleshooting** of terminal faults.

The **IBUC** comes with a complete set of diagnostic tools including:

- 10 MHz input detector
- Input voltage and current monitoring
- Transmit L-band input level detector
- Transmit RF output level detector
- User configurable thresholds and alarms

For additional information contact Terrasat Sales at +1 408-782-5911 or by Email: Sales@Terrasatinc.com.
235 Vineyard Court, Morgan Hill, CA 95037 www.terrasatinc.com

Ka-Band IBUC, 29.5-30.0 GHz

| Frequency range | RF | IF | SSB Phase Noise | External Reference | IBUC |
|-------------------------|-------------------------------|----------------|-----------------|--------------------|-------------|
| | 29.5 to 30.0 GHz | 1.0 to 1.5 GHz | 10 Hz | -105 dBc/Hz | -32 dBc/Hz |
| | | | 100 Hz | -135 dBc/Hz | -62 dBc/Hz |
| Input VSWR/Impedance | 1.5:1 / 50 Ohm | | 1 kHz | -145 dBc/Hz | -72 dBc/Hz |
| Input Connector | Type N female (50 Ohm) | | 10 kHz | -155 dBc/Hz | -82 dBc/Hz |
| Input Connector options | Type F (75 Ohm), TNC (50 Ohm) | | 100 kHz | -155 dBc/Hz | -92 dBc/Hz |
| Input power detector | -55 to -20 dBm | | 1 MHz | -155 dBc/Hz | -102 dBc/Hz |

Gain

Small Signal Gain (L-band to RF) with attenuator set to 0 dB.

| | |
|------|------------|
| 20 W | 74 dB min. |
| 40 W | 77 dB min. |

Attenuator range 30 dB in 0.1 dB steps

Gain flatness

| | |
|-----------|--------------|
| Full band | 3 dB p-p max |
| 36 MHz | 1 dB p-p max |

Gain variation over temperature

| | |
|-----------|--------------|
| Open loop | 3 dB p-p max |
| With AGC | 1 dB p-p max |

RF Output

| | | |
|--------------|-------------------------|----------------|
| Interface | WR28 UG cover w/ groove | |
| VSWR | 1.3:1 max | |
| Output Power | P_{sat} | P_{linear}^* |
| 20 W | +43 dBm min. | +40 dBm |
| 40 W | +46 dBm min. | +43 dBm |

* P_{linear} defined in accordance with MIL-STD-188-164A

| | |
|-----------------------------|-----------------------|
| Level stability with ALC | ± 0.5 dB |
| Output power detector range | Rated power to -20 dB |
| Power reading accuracy | ± 1.0 dB max. |

| | | |
|----------|-------------|-----------------------------|
| Spurious | in band | -60 dBc |
| | out of band | Complies with EN 301 459 |

AM/PM Conversion < 2 deg/dB @ P_{linear}

Output Noise Power Density, TX < -81 dBm/Hz

External Reference (multiplexed on TX IFL)

| | |
|-----------------------------|---------------|
| Frequency | 10 MHz |
| Level | -12 to +5 dBm |
| Internal reference optional | |

Local Oscillator Frequency

| | |
|-------|---------------|
| Sense | 28500 MHz |
| | Non-inverting |

IBUC Power Supply

| | DC | AC |
|-------------------------------------|-----------------|----------------|
| Voltage | 48 ± 11 VDC | 100 to 240 VAC |
| Power Consumption (@ P_{linear}) | | |
| 20 W | 200 W | 250 VA |
| 40 W | 400 W | 500 VA |

Monitor and Control

FSK (multiplexed on TX IFL), RS232/485
Hand-held Terminal, TCP / IP (HTTP, Telnet, SNMP)

Environmental

| | |
|-----------------------|------------------------|
| Operating temperature | -40°C to +60°C |
| Relative humidity | 100% condensing |
| Altitude | 10,000 ft (3,000m) ASL |

Mechanical

| | DC powered | AC powered |
|------|------------------|------------------|
| 20 W | 12.2x7.2x6.7 in. | 12.2x7.2x7.0 in. |
| | 18.5 lbs | 19.5 lbs |
| 40 W | 16x10x7.8 in. | 16x10x7.8 in. |
| | 32 lbs | 33 lbs |



Ka-Band IBUC Band 1 Data Sheet 8/16/12

Specifications are subject to change without notice



235 Vineyard Court, Morgan Hill, CA 95037
Tel. +1 408-782-5911 Fax +1 408-782-5912
www.terrasatinc.com



Ka-Band IBUC 30-31 GHz Intelligent Block Upconverter

IBUC Advantages

Integrated BUC/SSPA packaging for higher performance and reliability.

All models available with integral AC power supply or separate DC power supply.

NMS-friendly interfaces enable remote management of your earth station RF.

Embedded web pages provide management for small networks using any web browser.

AGC or ALC circuits hold gain or output level constant.

30dB User-adjustable gain in 0.1 dB steps preserves modem dynamic range.

1+1 switching logic and drivers built into the IBUC eliminate expensive external switching controller.

Advanced user interfaces:

- TCP/IP HTTP with embedded web pages.
- SNMP
- TELNET through TCP/IP
- FSK through TX IFL cable.
- RS232/485 serial port.
- Handheld terminal



The revolutionary **IBUC** has advanced features to take your network to new heights.

IBUC offers significant benefits:

- Low terminal cost
- Simple design and installation
- Superior RF performance
- Simplified 1+1 configuration

New interfaces connect you to the **IBUC**'s extensive M&C facilities for network management or local access. This powerful new M&C enables:

- **Trouble free commissioning** with easy, point-and-click installation/configuration
- Continuous **verification** of performance with time-stamped alarm history.
- Simplified **troubleshooting** of terminal faults.

The **IBUC** comes with a complete set of diagnostic tools including:

- 10 MHz input detector
- Input voltage and current monitoring
- Transmit L-band input level detector
- Transmit RF output level detector
- User configurable thresholds and alarms

For additional information contact Terrasat Sales at +1 408-782-5911 or by Email: Sales@Terrasatinc.com.
235 Vineyard Court, Morgan Hill, CA 95037 www.terrasatinc.com

Ka-Band IBUC, 30-31 GHz

| Frequency range | RF | IF | SSB Phase Noise | External Reference | IBUC |
|-------------------------|-------------------------------|----------------|-----------------|--------------------|-------------|
| | 30 to 31 GHz | 1.0 to 2.0 GHz | 10 Hz | -105 dBc/Hz | -32 dBc/Hz |
| | | | 100 Hz | -135 dBc/Hz | -62 dBc/Hz |
| | | | 1 kHz | -145 dBc/Hz | -72 dBc/Hz |
| Input VSWR/Impedance | 1.5:1 / 50 Ohm | | 10 kHz | -155 dBc/Hz | -82 dBc/Hz |
| Input Connector | Type N female (50 Ohm) | | 100 kHz | -155 dBc/Hz | -92 dBc/Hz |
| Input Connector options | Type F (75 Ohm), TNC (50 Ohm) | | 1 MHz | -155 dBc/Hz | -102 dBc/Hz |
| Input power detector | -55 to -20 dBm | | | | |

Gain

Small Signal Gain (L-band to RF) with attenuator set to 0 dB.

| | |
|------|------------|
| 20 W | 74 dB min. |
| 40 W | 77 dB min. |

Attenuator range 30 dB in 0.1 dB steps

Gain flatness

| | |
|-----------|----------------|
| Full band | 4 dB p-p max |
| 36 MHz | 1.5 dB p-p max |

Gain variation over temperature

| | |
|-----------|--------------|
| Open loop | 4 dB p-p max |
| With AGC | 1 dB p-p max |

RF Output

| | | |
|--------------|-------------------------|----------------|
| Interface | WR28 UG cover w/ groove | |
| VSWR | 1.3:1 max | |
| Output Power | P_{sat} | P_{linear}^* |
| 20 W | +43 dBm min. | +40 dBm |
| 40 W | +46 dBm min. | +43 dBm |

* P_{linear} defined in accordance with MIL-STD-188-164A

| | |
|-----------------------------|-----------------------|
| Level stability with ALC | ± 0.5 dB |
| Output power detector range | Rated power to -20 dB |
| Power reading accuracy | ± 1.0 dB max. |

| | | |
|----------|-------------|---------|
| Spurious | in band | -55 dBc |
| | out of band | -55 dBc |

AM/PM Conversion < 2 deg/dB @ P_{linear}

Output Noise Power Density, TX < -81 dBm/Hz

External Reference (multiplexed on TX IFL)

| | |
|-----------------------------|---------------|
| Frequency | 10 MHz |
| Level | -12 to +5 dBm |
| Internal reference optional | |

Local Oscillator Frequency

| | |
|-------|---------------|
| Sense | 29000 MHz |
| | Non-inverting |

IBUC Power Supply

| | DC | AC |
|-------------------------------------|-----------------|----------------|
| Voltage | 48 ± 11 VDC | 100 to 240 VAC |
| Power Consumption (@ P_{linear}) | | |
| 20 W | 200 W | 250 VA |
| 40 W | 400 W | 500 VA |

Monitor and Control

FSK (multiplexed on TX IFL), RS232/485
Hand-held Terminal, TCP / IP (HTTP, Telnet, SNMP)

Environmental

| | |
|-----------------------|------------------------|
| Operating temperature | -40°C to +60°C |
| Relative humidity | 100% condensing |
| Altitude | 10,000 ft (3,000m) ASL |

Mechanical

| | DC powered | AC powered |
|------|------------------|------------------|
| 20 W | 12.2x7.2x6.7 in. | 12.2x7.2x7.0 in. |
| | 18.5 lbs | 19.5 lbs |
| 40 W | 16x10x7.8 in. | 16x10x7.8 in. |
| | 32 lbs | 33 lbs |

IBUC 1:1 Protection System

Advantages

1:1 switching logic and drivers reside in the IBUCs - no external logic controller required.

Supports IBUC's with AC power input or separate DC power supplies.

Web browser interface with embedded web pages for easy setup, monitor, and control.

Auto-Cloning function means user sets up primary IBUC as desired and secondary unit clones its settings.

LEDs provide quick visual indication of IBUC condition.

Compact, integrated mounting package.

Separate outdoor RX 1:1 system available in AC-powered version or operating with DC power from IBUC power supplies.

Access via:

- FSK through TX IFL cable.
- TCP/IP with embedded web pages.
- SNMP agent
- RS485/232 serial port.
- Handheld Terminal.

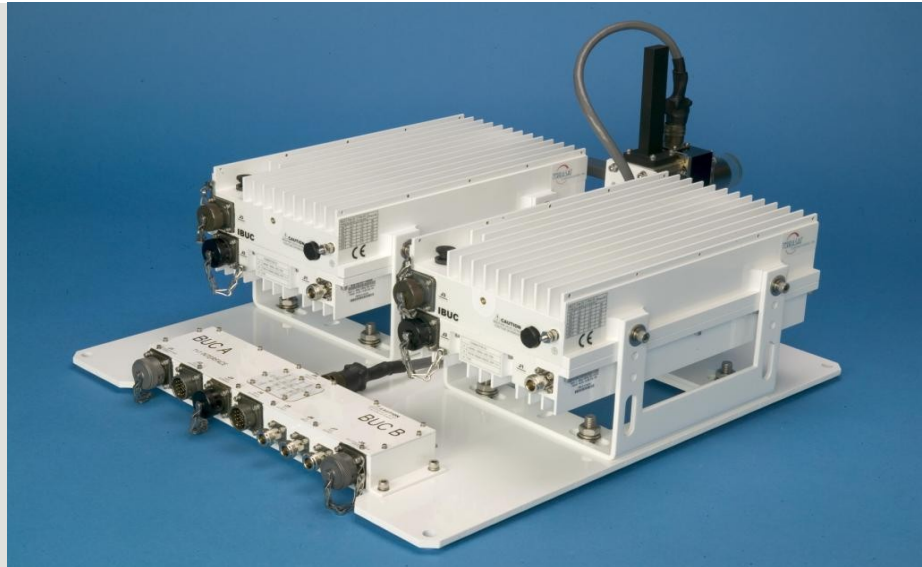

The IBUC redefines 1:1 protection switching. Instead of using a separate switching logic unit with its expense and complexity, Terrasat incorporates the switching logic and drivers into the IBUC itself.

Protected units monitor each other's alarm condition and, through a simple switching junction box, make the decision to switch. The IBUC 1:1 package includes a cloning feature to simplify 1:1 setup. Terrasat's 1:1 solution is a complete package with a dual-IBUC mounting bracket for convenient installation.

A 1:1 junction box mounts on the 1:1 mounting plate. Practically a passive unit, the junction box manages the functions of dividing the IF signal and routing signals through an Ethernet switch. It supports interface connectors and includes a bank of LEDs for visual indication of alarm conditions. The user interface is via web browser to embedded web pages, handheld terminal, RS232 or RS485.

A Receive 1:1 system is available with a separate outdoor RX interface box. The receive interface box receives DC power from the IBUC power supplies and performs all required functions for 1:1 operation of LNB's. An AC-powered model is available. No indoor controller is necessary. Monitoring and control is via TCP/IP port on the interface box. The interface box fits the Terrasat universal mounting bracket and the system comes with cables and waveguide switch.

IBUC 1:1 System Block Diagram

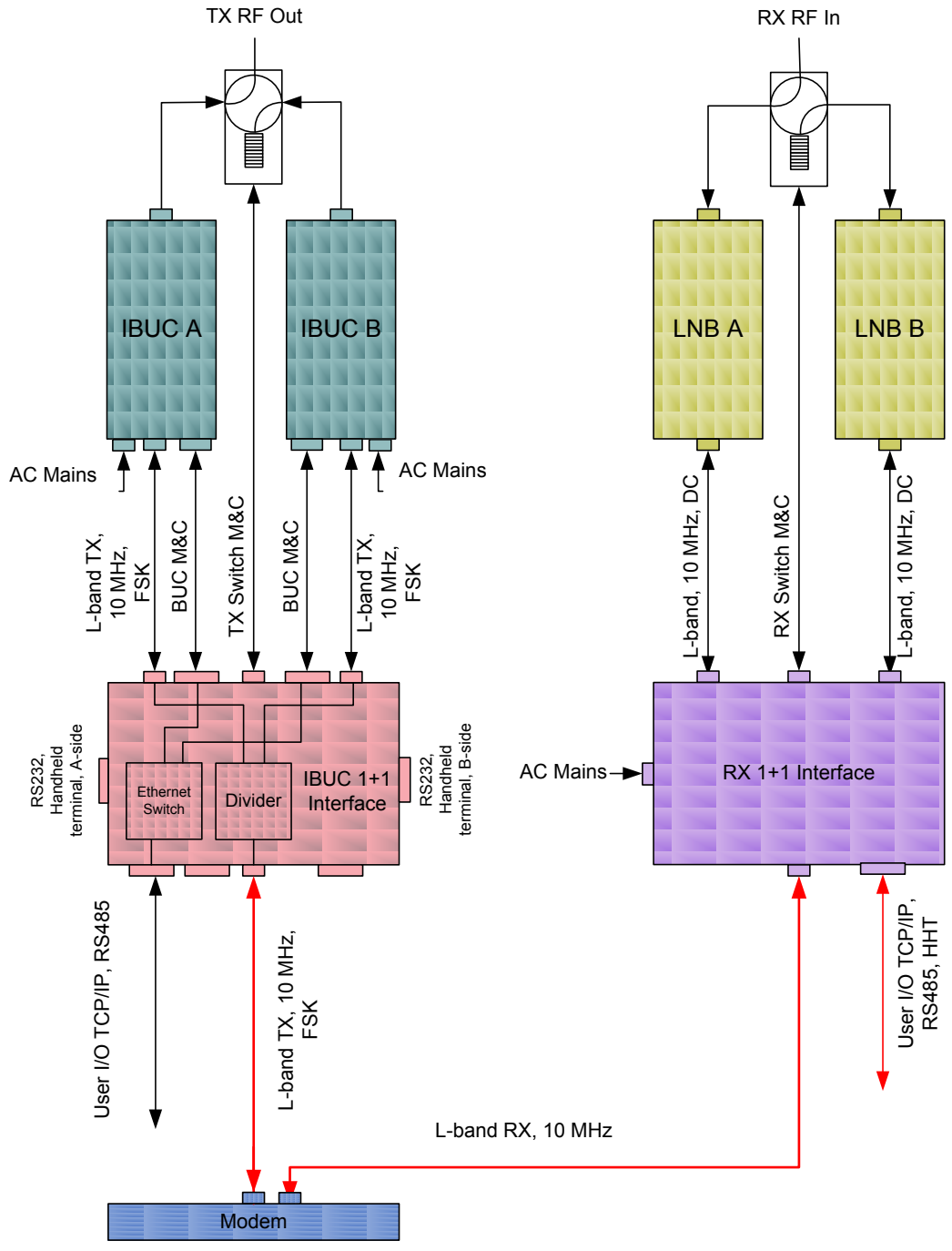

Specifications are subject to change without notice

1:1 System Data Sheet 08 06 10



235 Vineyard Court, Morgan Hill, CA 95037
 Tel. +1 408-782-5911 Fax +1 408-782-5912
 www.terrasatinc.com

GLOSSARY**Glossary of Terms**

The following acronyms are used in Terrasat Communications, Inc. documentation:

| | |
|--------|-----------------------------------|
| °C | Degrees Celsius |
| °K | Degrees Kelvin |
| 1RU | One Rack Unit (1.75 in.) |
| μs | Microsecond |
| AC | Alternating Current |
| AGC | Automatic Gain Control |
| ALC | Automatic Level Control |
| AWG | American Wire Gauge |
| ATE | Automated Test Equipment |
| ATP | Acceptance Test Procedure |
| BER | Bit Error Rate |
| BUC | Block Upconverter |
| CSM | Continuous Signal Mode |
| CW | Continuous Wave |
| DAB | Digital Audio Broadcasting |
| dB | Decibel |
| dB/oct | Decibel per Octave |
| dBc | Decibel Below Carrier |
| dBm | Decibel referenced to 1 milliwatt |

| | |
|------|--|
| DBS | Direct Broadcast Satellite |
| DC | Direct Current |
| DCE | Data Communication Equipment |
| DRO | Dielectric Resonator Oscillator |
| DTE | Data Terminal Equipment |
| DVM | Digital voltmeter |
| EMC | Electromagnetic Compatibility |
| EMI | Electromagnetic Interference |
| ERM | <u>E</u> lectromagnetic Compatibility and <u>R</u> adio Spectrum <u>M</u> atters |
| fr | Frequency |
| FSK | Frequency Shift Keying |
| FSS | Fixed Satellite Services |
| F/W | Firmware |
| g | Gravity |
| GHz | Gigahertz |
| GUI | Graphical User Interface |
| HHT | Hand-held Terminal |
| HPA | High-Power Amplifier |
| HPC | High-Power Converter |
| HTTP | Hypertext Transfer Protocol |
| Hz | Hertz |
| I/O | Input/Output |
| IBUC | Intelligent Block Upconverter |
| IDU | Indoor Unit |
| IF | Intermediate Frequency |
| IFL | Interfacility Link |
| IFU | Interface Unit |
| IP | Internet Protocol |
| kg | Kilogram |
| LNB | Low Noise Block Converter |
| LO | Local Oscillator |
| M&C | Monitor and Control |
| max | Maximum |

| | |
|---------|--|
| MCPC | Multiple Carrier Per Channel |
| MHz | Megahertz |
| MIB | Management Information Base |
| min | Minimum |
| ms | Millisecond |
| MTBF | Mean Time Between Failure |
| MUC | Microwave Upconverter |
| ns | Nanosecond |
| OCXO | Oven-controlled Quartz Oscillator |
| ODU | Outdoor Unit |
| OMT | Orthogonal Mode Transducer |
| p-p | Peak to Peak |
| P1dB | Power at the 1dB Compression Point |
| PFC | Power Factor Corrected |
| PLDRO | Phase-Locked Dielectric Resonator Oscillator |
| PLL | Phase-Locked Loop |
| PLLNBC | Phase-Locked Low-Noise Block Converter |
| PLO | Phase Locked Oscillator |
| ppb | Parts Per Billion |
| ppm | Parts Per Million |
| PSUI | Power Supply Unit |
| Pwr | Power |
| QTP | Qualification Test Procedure |
| QPSK | Quadrature Phase Shift Keying |
| RF | Radio Frequency |
| RFT | Radio Frequency Transceiver |
| RH | Relative Humidity |
| RMS | Root Mean Square |
| RTC | Real Time Clock |
| RTS/CTS | Request to Send/Clear to Send |
| Rx | Receive |
| s | Second |

| | |
|--------|---|
| SCPC | Single Carrier Per Channel |
| SNG | Satellite News Gathering |
| SNMP | Simple Network Management Protocol |
| SSB | Single Side Band |
| SSPA | Solid-State Power Amplifier |
| TCP/IP | Transfer Control Protocol/Internet Protocol |
| TRF | Transmit Reject Filter |
| Tx | Transmit |
| UDP | User Datagram Protocol |
| UPC | Upconverter |
| UPS | Uninterruptible Power Supply |
| VAC | Volts Alternating Current |
| VDC | Volts Direct Current |
| VSAT | Very Small Aperture Terminal |
| VSWR | Voltage Standing Wave Ratio |
| VVA | Variable Voltage Attenuator |
| W | Watt |
| WG | Waveguide |

INDEX

Numerics

10 MHz reference signal
priority, 2-12

A

AC mains protection, 3-8
accessories
 IBUC, 3-4
alarm log
 incorrect time stamp, 4-8
alarms
 default configuration, 5-4
ANATEL
 compliance, 1-6
 Homologação, 1-6
antenna
 mounting recommendations, 3-9 to 3-15
anti-seize lubricant, 3-15
anti-sieze lubricant, 3-2
ASCII commands
 common, C-4
 receive only, C-18
 transmit only, C-25
ASCII Mode
 command formats, 5-7
 response format, 5-7
attenuation, 2-16, 2-17
autocloneing
 Tx 1+1, 7-6
automatic gain control (AGC), 2-16
automatic level control (ALC), 2-16, 4-5
avoiding
 signal saturation, 4-9

B

block diagram
 IBUC, 2-14
 Tx 1+1, 7-3

breather valve, 3-15
burst mode
 IBUC power measurement, 5-17

C

cable loss
 J1 connector, 3-21
cable shielding, 3-8
caution symbol
 J1 connector, 3-21
checks
 M&C, 6-2
 power supply, 6-2
clock
 system, 4-8
common mode
 noise, 6-2
compliance
 ANATEL, 1-6
configuring SNMP, 5-15 to 5-16
connector schedule
 IBUC, 3-20
 Tx 1+1, 7-8
continuous signal mode
 IBUC power measurement, 5-18
coupling factor, 3-23
CSM
 See continuous signal mode

D

data packet configuration, 5-8
data transmission rate
 FSK, 5-5
 RS485, 5-6
default transmit alarms, 5-4
DHCP, 7-29
disconnect device
 circuit breaker, 3-7
 mains supply plug, 3-7

E

- electromagnetic interference
 - sources, 3-6
- enabling the hand-held terminal, E-1
- equipment for installation, 3-28
- Ethernet
 - SNMP, 5-15
- export regulations, 1-5

F

- factory configuration
 - IP address, 5-9
 - IP gateway, 5-9
 - subnet mask, 5-9
 - Telnet, 5-9
- fire codes
 - compliance with, 3-21
- frequency plans
 - transmit, 2-2
- FSK data synchronization, 5-5
- FSK data transmission rate, 5-5
- FSK link specifications
 - receiver, 5-5
 - transmitter, 5-5
- furnished items
 - IBUC, 3-2
 - Tx 1+1 system, 3-3
- fuses
 - type, 2-4

G

- grounding
 - IBUCs, 3-8
 - lightning protection, 3-9
 - Tx 1+1, 7-12

H

- hand-held terminal
 - activation, 5-2
 - adaptive learning, E-2
 - disconnecting from, E-2
 - IBUC menu tree, E-3
- Homologação junto à ANATEL, 1-6
- HyperTerminal
 - establishing a session, B-1

I

IBUC

- accessories, 3-4
- available bands, 2-1
- block diagram, 2-14
- cables and connectors, 3-16 to 3-27
- gain, 2-13
- L-band input, 2-12
- power measurement
 - burst mode, 5-17
 - continuous signal mode, 5-17
- required inputs, 2-12
- sample port, 3-23
- system components, 2-1 to 2-17
- system configurations, 2-17 to 2-22
- waveguide connections, 3-26

IFL

- See* interfacility link
- installation test equipment, 3-28
- interface frequency, 2-1
- interfacility link
 - definition, 2-1
- International Traffic In Arms Regulations
 - See* ITAR
- IP address, 5-9
- IP gateway, 5-9
- ITAR
 - compliance, 1-6
 - regulations, 1-5

J

- J1 connector
 - cable loss, 3-21

L

- L-band input, 2-12
- LEDs
 - M&C interface, 5-3
- Legacy Binary mode, 5-7
- lightning
 - protection, 7-13
- lubricant
 - anti-seize, 3-15
 - anti-sieze, 3-2

M

M&C interfaces

- Ethernet
 - SNMP, 5-15
- multifunction LEDs, 5-3
- RS232, 5-1
- RS485
 - ASCII mode, 5-6
 - legacy binary mode, 5-7

mastic tape, 3-24, 7-11

MIBs, 5-17

monitor and control

See M&C

mounting considerations

IBUCs, 3-6

multifunction LEDs, 5-3

N

noise

- common mode, 6-2
- normal mode, 6-2

O

ODU

- components, 3-1
- mounting, 3-6

outdoor unit

See ODU

P

part number identification, A-1

Plenum cables, 3-21

positive supply, 3-23

power measurement

modes, 5-17

power protection devices, 6-2

power requirements

IBUC, 3-6

power supply checks, 6-2

pressure window, 3-15

protection

- lightning, 7-13
- power mains, 3-8

PSUI

AC power connector, 3-7

mating connectors, 3-8

R

receiver link specifications, 5-5

reference documents

satellite operation, 1-2

reference signal

priority, 2-12

repair policy, 6-7

replacement fuse type, 4-7

returned material authorization, 6-8

RF signal flow

required inputs, 2-12

RMA procedure, 6-8

rods

ground, 3-9

RS232

initiating a session, 5-1

RS485

ASCII mode

response format, 5-7

configuring, 5-6

data transmission rate, 5-6

legacy binary mode, 5-7

Rx reject filter, 3-26

S

safety requirements

circuit breaker, 3-7

disconnect device, 3-7

sample port

IBUC, 3-23

saturation

transmit power, 6-3

serial number identification, A-1

signal saturation

avoidance, 4-9

Significant Military Equipment, 1-5

site considerations

IBUCs, 3-6

SNMP

configuration, 5-15

MIBs, 5-17

traps, 5-15, F-19

- solid-state power amplifier, 2-13
- standards
 - satellite operation, 1-2
- start-up checklist, 4-1
- storage limitations
 - IBUC, 2-23
- subnet mask, 5-9
- supply voltage options, 2-3
- system clock, 4-8
- system components
 - IBUC, 2-1 to 2-17
 - Tx 1+1, 7-3
- system pressurization, 3-15
- system requirements, 2-17

T

- Telnet
 - default port, 5-14
 - initiating a session, 5-14
- test equipment, 3-28
- thresholds
 - Tx Input, 4-4
 - Tx Output, 4-4
- time
 - system, 4-8
- time stamp
 - incorrect data, 4-8
- transceiver faults, 6-1
- transients, 6-2
- transmit alarm default configurations, 5-4
- transmit frequency plans, 2-2
- transmit redundant
 - See* Tx 1+1
- traps
 - SNMP, 5-15, F-19
- Tx 1+1
 - autoclone, 7-6
 - block diagram, 7-3
 - interface module
 - block diagram, 7-5
 - connectors, 7-4, 7-8
 - system components, 7-3

U

- Ufer ground
 - definition, 3-9

V

- variable attenuator, 2-17
- voltage drop, 2-18, 3-21
- voltage options, 2-3
- voltage ranges, 2-3

W

- warranty policy, 1-4
- warranty seals
 - breaking, 1-5
- water-resistant wrap
 - See* mastic tape
- waveguide
 - IBUC connections, 3-26
 - IBUC flange types, 2-13, 3-23
 - pressurization, 3-15